

SitOnIt • Seating®

Price List November 4, 2024



TABLE OF CONTENTS

Intro

Sustainable Design.....	7
Warranty.....	8
Ordering Information.....	11
CAL 133.....	15
Fabric.....	17
COM/COL.....	18
COM/COL Test Request Form.....	19

COM & Special Upholstery Form.....	20
COM Calculation.....	21
COM/COL Yardage: Task and Conference.....	22
COM/COL Yardage: Multipurpose and Side.....	26
COM/COL Yardage: Lounge.....	29
Custom Finish Program.....	32

Task, Light Task, Executive and Conference Chairs and Stools

Amplify

Mesh Back Task Chair.....	38
Mesh Back Task Stool.....	42
Upholstered Back Task Chair.....	46
Upholstered Back Task Stool.....	50

Anytime

Light Task Chair and Stool.....	53
---------------------------------	----

Focus

Mesh Back Task Chair.....	56
Mesh Back Task Stool.....	61
Upholstered Back Task Chair.....	65
Upholstered Back Task Stool.....	70

Focus 2.0

Mesh Back Task Chair.....	74
Mesh Back Task Stool.....	79

Glove Active

Conference Chair.....	83
-----------------------	----

Glove Executive

Conference Chair.....	87
-----------------------	----

Hexy

Task and Conference Chair.....	90
Mesh Back Task Stool.....	94

InFlex

Light Task Chair and Stool.....	98
---------------------------------	----

Ioniq

Collaborative Chair.....	101
--------------------------	-----

Knack

Upholstered Back Task Chair.....	104
Upholstered Back Task Stool.....	108

Lavo

Task Chair.....	111
-----------------	-----

Lumin

Light Task Chair and Stool.....	115
---------------------------------	-----

Mavic

Collaborative Chair.....	119
--------------------------	-----

Movi

Light Task Chair and Stool.....	122
---------------------------------	-----

Non-Stop Heavy Duty XL

Task Chair.....	126
Task Stool.....	129

Novo

Mesh Back Task Chair.....	132
Mesh Back Task Stool.....	137

OnCall

Light Task Chair and Task Stool.....	141
--------------------------------------	-----

Orbix

Light Task Chair and Stool.....	145
---------------------------------	-----

Prava

Conference Chair.....	148
-----------------------	-----

ReAlign

Task Chair.....	152
Task Stool.....	157

TABLE OF CONTENTS

Task, Light Task, Executive and Conference Chairs and Stools

Relay		TR2	
Light Task Chair and Stool	161	Task and Executive Chair	180
Rio		Task Stool	184
Light Task Chair and Stool	165	Vectra	
Sephen		Mesh Back Task Chair	188
Conference Chair	169	Wit	
Sona		Mesh Back Task Chair	192
Conference Chair	172	Mesh Back Task Stool	196
Torsa		Thintex Back Task Chair	200
Task Chair	176	Thintex Back Task Stool	204

Multipurpose, Side and Guest Chairs ; Counter and Bar Stools

Achieve		Mika	
Multipurpose Chair	212	Multipurpose Chair, Counter Stool and Bar Stool	263
Anytime		Movi	
Multipurpose Chair and Bar Stool	215	Mesh-Back Nester Chair	267
Baja		OnCall	
Multipurpose Chair and Bar Stool	219	Multipurpose Chair and Bar Stool	271
Cora		Orbix	
Multipurpose Chair, Bariatric, Counter Stool and Bar Stool	224	Multipurpose Chair and Bar Stool	275
Cora		Qwiz	
Replacement Seating Parts	229	Nester Chair	279
Flyte		Relay	
Stacking Nester Chair	230	Multipurpose Chair	283
Focus Side		Relay	
Multipurpose Chair, Counter Stool and Bar Stool	234	Nester Chair	286
Freelance		Rio	
Multipurpose Chair, Counter Stool and Bar Stool	239	Multipurpose Chair, Counter Stool and Bar Stool	289
Bariatric Chair	245	Rowdy	
InFlex		Multipurpose Chair	293
Multipurpose Chair, Counter Stool and Bar Stool	248	Sprout	
Ioniq		Multipurpose Chair	296
Guest Chair	252	Wit Side	
Side Chair	254	Mesh Back Multipurpose Chair	299
Kickstand		Thintex Back Multipurpose Chair	302
Stool	256		
Lumin			
Multipurpose Chair, Counter Stool and Bar Stool	258		

Lounge

Aviera

Guest and Bariatric Seating	312
Hip Chair	317
Patient Seating	321
Freespan Multiseating	326
Preconfigured Tandem Multiseating.....	331
Start/Center/End Tandem Multiseating	336
Linking Tables.....	341

Aviera

Replacement Seating Parts.....	344
--------------------------------	-----

Cameo

Seating and Benches	345
Inline and Coffee Tables	350

Composium

Curve Club Chair, Settee and Sofa	352
Flair Club Chair, Settee and Sofa	357
Sharp Club Chair, Settee and Sofa	362
Ottoman and Benches	367

Envoi

Lounge Seating	372
----------------------	-----

Tables and Desks

Mezzanine

End Table, Coffee Table and Corner Table	443
Occasional Table	446

Ocala

Flip-Top Tables	449
Typicals.....	453

Parallon

Flip-Top and Fixed Top Training Table.....	457
Meeting, Café and Occasional Table	465

Surge

2-Leg Height-Adjustable Table.....	470
------------------------------------	-----

Gobi

Lounge Seating	376
----------------------	-----

Kindl

Guest and Bariatric Seating	379
Freespan and Preconfigured Multiseating	384
Linking Tables for Start/Center/End	388
Start/Center/End Multiseating.....	391

Nano

Modular Lounge Typicals	396
Modular Lounge	402

Paséa

Modular Lounge Typicals	406
Modular Lounge Seating	411
Tables and Ottomans	419
Inline Tables.....	423

Sable

Lounge Seating	426
----------------------	-----

Visit Modular

Club Chair and Ottoman	431
------------------------------	-----

Switchback

2-Leg Height-Adjustable Table Bundle	474
2-Leg Height-Adjustable Table.....	480
3-Leg Height-Adjustable Table Typicals.....	485
3-Leg Height-Adjustable Table.....	488

Tensor

Café, Classroom, and Office Typicals	499
Café Table	502
Multipurpose Table.....	506
Desking	510

Uni

Laptop Table.....	520
-------------------	-----

Benching

HiQ

Height-Adjustable Benching	523
----------------------------------	-----

Prise

Benching Typicals	535
Benching	540

Screens

Doodle

Markerboard Worksurface Screen	561
--------------------------------------	-----

Modesty

Laminate Screens.....	565
-----------------------	-----

Motif

Fabric Worksurface Screen	567
Mobile + Freestanding Fabric Screen	573
Modesty Screen	576

Monitor Arms

Mobio

Monitor Arm	598
-------------------	-----

Accessories

Anti-Fatigue Mat.....	605
Cable Caddy	606
CPU Storage	607
Current Power	608
EON Power.....	609
High Tide	610

Appendix

Stand-Alone Tabletops.....	619
Super Duty Series Guide.....	626
Glide Guide.....	629
Stacking Guide.....	630
Mechanism Function Guide	636
Care and Cleaning.....	639

Power Beam

EBEAM

Power + Data Beam	553
-------------------------	-----

Sector

Acrylic Worksurface Screen	578
Mobile + Freestanding Acrylic Screen	582
Acrylic Seating Screen	584
Acrylic Café Screen.....	587
Acrylic Transaction Screen.....	589
Tri-Fold Acrylic Meeting and Single-Table Screen	591
Acrylic Modesty Screen	594

Unity G2

Monitor Arm	602
-------------------	-----

Keyboard Tray	611
Laptop Storage	613
Mobile Pedestal.....	614
Pencil Storage.....	616
Rhythm Lighting	617

Laminate Color Program	641
Mesh Color Program	644
Plastics Color Program.....	646
Multipurpose Chair Options	647
Executive and Conference Chair Options	649
Product Code Index	654

SitOnIt • Seating®

CALIFORNIA BORN AND BRED

We're a leading manufacturer of commercial solutions in the U.S.—and #1 in task chairs. From tables and lounge to screens and more, we've been the go-to destination for comprehensive, build-to-order solutions for over 25 years.

We combine award-winning design with the fastest lead times around (choose from 2-, 5- or 10-day shipping). We can build almost any specification you want, deliver it when you need it and offer a price no one can match. It's all part of our indie California spirit and drive to help you do more.

DESIGN THAT GETS YOU

Discover seating engineered around you. Experience responsive design, supreme comfort and hyper-customizable features—all at value-driven prices.

OUR BUILD-TO-ORDER PROMISE

Custom-designed chairs, no waiting. Our nimble size and lean manufacturing operation means we can ship build-to-order chairs in just two days.

FASTEST SHIPPING IN THE INDUSTRY

Choose from two, five, or 10 day shipping. We cut lead time, sync orders and avoid off-schedule shipments at a rate our competitors just can't match.

WORLD-CLASS SERVICE

We're proud to announce that the Office Furniture Dealer Alliance voted for us as "Best Customer Service" three times in the past five years.

SUSTAINABLE DESIGN

We make it easy to go green. Design an eco-friendly room from the ground up or upgrade an existing space to meet the latest environmental standards.



ANSI/BIFMA Certified

SitOnIt Seating is a member of the Business and Institutional Furniture Manufacturer's Association (BIFMA). Tests developed by BIFMA are approved by the American National Standards Institute (ANSI) to determine the strength and durability of seating. Although testing is not a warranty or guarantee, our task, side and lounge products meet or exceed BIFMA and ANSI standards.



LEED Certified

Earn points toward LEED certification thanks to our U.S. manufacturing location and our use of recycled materials where possible.



GREENGUARD Certification

All SitOnIt Seating lounge and seating products met the rigorous criteria required by GREENGUARD in accordance with the Collaborative for High Performance Schools.



LEVEL Certified

Sustainability matters. That's why we've worked to achieve BIFMA LEVEL® certification for all task chairs, side chairs and lounge products.



The Take Back Program

SitOnIt Seating helps minimize product waste by connecting our customers and dealers with third-party groups who redirect materials that would be headed for the landfill to local nonprofits and public agencies.



We Did Our Homework

Download detailed documents that break down the percentage of recycled content, manufacturing processes and indoor air emissions for every chair we make.

WARRANTY

Product Warranty Periods

Exemplis LLC, d.b.a. SitOnIt Seating (hereafter referred to as the Company), warrants to the original end user that this product will be free from defects in its material and workmanship when used in a single shift (standard eight-hour day, five days per week) for the following warranty periods:

LIFETIME WARRANTY COVERAGE:

- All SitOnIt Seating products, except where noted below
- Structural Components: eBEAM, HiQ, Parallon, Prise, Surge, Switchback and Voyager
- Structural: Kindl frame.

12-YEAR WARRANTY COVERAGE:

- Amplify, Cora (Guest, Hip and Stool), Kindl (bariatric, guest, freespan and preconfigured), Novo, Torsa, and Wit used in multi-shift (24/7) applications.
- Lounge seating and occasional/lounge tables
- Bases: Ocala, Tensor
- Laminate tops
- Monitor arms¹: Mobio series, Unity G2
- Plastic shells

10-YEAR WARRANTY COVERAGE:

- Non-Stop Heavy Duty, Cora (Midsize and Bariatric), Freelance Bariatric and chairs purchased with a Heavy Duty (HD) or Large and Tall (LT) option used in multi-shift (24/7) applications
- Electrical Components: eBEAM, HiQ, Parallon, Prise, Surge and Switchback

FIVE-YEAR WARRANTY COVERAGE:

- Fabric, foam, knit back, and mesh
- All filing products³
- CPU holders
- Screens⁴
- High Tide
- Keyboard trays
- Lighting fixtures
- Power components⁵: EON, Current, Power Strips
- Wire management

TWO-YEAR WARRANTY COVERAGE:

- Fabric and foam cushioning for Non-Stop Heavy Duty, Freelance Heavy Duty, Cora Midsize and Bariatric, Kindl bariatric and chairs purchased with an HD or LT option
- Multipurpose felt glides
- Half-Moon Pencil Drawer

ONE-YEAR WARRANTY COVERAGE:

- Lighting power supplies
- Mouse pads
- Wrist rests

1. Weight capacity of the monitor arms must be followed. If an arm is not functioning properly because of the weight of the monitor is outside of the advertised weight capacity, the monitor arm will not be considered defective under the warranty.

2. Please note that electrical components on a height-adjustable table include: hand controls, motors, control boxes and electrical cables.

3. This warranty does not cover damage from ordinary wear and tear, including paint finish changes and/or discoloration resulting from aging or exposure to light.

4. Warranty limited to finishes, tacking surface of tack boards and writing surface of whiteboards. Standard textiles limited to original manufacturer's warranty.

5. Power components are defined as any power unit with electrical outlets and/or USB/data connections, connector jumper cables for daisy chain and infeeds for hardwire applications.

WARRANTY

Freight Warranty

At SitOnIt Seating™, we take pride in crafting one-of-a-kind pieces. Products are thoughtfully inspected prior to being carefully wrapped and packed for shipment. Upon receiving your order, should your order be less than perfect, please follow these steps for an expedited resolution:

IF DAMAGE IS VISIBLE:

- Please accept shipment and report damages on the freight bill.
- Contact SitOnIt Seating Customer Experience to report the issue **within 10 days** after delivery.

IF DAMAGE IS CONCEALED:

- Save merchandise and packaging.
- Take a photo to document the damage.
- Contact SitOnIt Seating Customer Experience to report the issue **within 60 days** after delivery.

Either way, we are here to help! SitOnIt Seating Customer Experience Team is on standby to assist Monday through Friday, 5:00 a.m. to 5:00 p.m. PST. Call (888) 274-8664 or email sitonit@exemplis.com.

The Company Does Not Warranty

- COM/COL textiles
- Product abuse or misuse
- Failure resulting from normal wear and tear
- User modification of or attachments to the product
- Products or parts not used, maintained or installed in accordance with the Company's installation, maintenance and/or applicable guidelines
- Products that are exposed to extreme environmental conditions and/or have been subject to improper storage
- Floor samples or display models
- The substitution or use of non-SitOnIt Seating components with SitOnIt Seating products
- Products purchased "as is" and/or secondhand
- Products sold by unauthorized dealers
- Creasing and/or gathering of textiles during upholstery application process
- Minor irregularities of color, surface, grain and texture
- Minor variations of color in textiles
- Variations of texture and natural markings such as neck wrinkles, scratches, backbone marks and stretch marks in leather
- Color matching of textiles exactly to samples, swatches or prior purchases

For orders shipping outside the contiguous 48 U.S. states or the common provinces of Canada (British Columbia, Alberta, Saskatchewan, Manitoba, Ontario, Quebec, New Brunswick & Nova Scotia), we will provide replacement parts and pre-approved labor as determined by our warranty team. However, matching our standard freight policy, we will only ship those replacement parts to a U.S. port. It is up to our dealer to handle freight costs from the U.S. port to their location.

WARRANTY

Applicable Provisions To All Products And Services

The Company will repair or replace with a comparable product, at its option, without charge to the original purchaser, only defective products or parts found defective during the Warranty Period. If requested by the Company, the original purchaser must return the part or product with freight or other shipping charges prepaid.

This warranty shall be effective for the applicable time period beginning from date of purchase as shown on original purchaser's original receipt or other proof of purchase.

For products purchased on or after August 1, 2012, the Company shall pay for all labor costs pre-approved by the Company. The payment of such pre-approved labor costs will be in the form of a credit to an active Company account.

There are no other warranties, expressed or implied, other than those specifically described, including, without limitations, any implied warranty or merchantability or of fitness for a particular purpose. The Company will not be responsible for incidental or consequential damages. Some states do not allow the exclusion or limitation of incidental or consequential damages, so the above limitations or exclusions may not apply to you. This warranty gives you specific legal rights and you may have other rights which vary from state to state.

Warranty claims must be reported within 60 days of any concealed damage. The Company will advise you of the procedure to follow when making warranty claims. Call the Company at the number below to explain the defect. Give your name, address and telephone number. Please be prepared with the model number and sales order number found under the seat of the chair.

SitOnIt Seating: (888) 274-8664

ORDERING INFORMATION

Pricing

All prices are suggested retail and are subject to change without notice. Visit our websites or contact Customer Experience for the latest pricing. Prices in effect at the time of shipment will prevail. We reserve the right to make changes in prices, models, fabrics, finishes, materials and specifications and also discontinue models and options at any time without notice.

Orders

Specify model number, quantity, desired delivery date and all other applicable information. Order templates can be found in the applicable Price Guide. Orders will be accepted with an acknowledgment form governing the transaction. In the event an error is made in the manufacture of the product, the acknowledgment will be used as the resolution document. Submit orders by email or fax:

SITONIT SEATING:

Email: purchaseorder@exemplis.com

Fax: (714) 995-4855

Minimums

FREIGHT PROGRAM

The freight program is designed to deliver freight prepaid to the designated consignee. To offset rapidly increasing costs, it requires a minimum quantity (three or more items) for select product categories. Premium freight services and/or guaranteed delivery may result in additional shipping charges.

NO MINIMUM REQUIREMENT:

- Task/Collaborative/Conference/Executive seating and task stools
- Side, nesting seating and stools
- Plastic seating
- Height adjustable tables (except tops)*
- Fixed and adjustable benches (except tops)*
- Power beam
- Training/meeting/Café/Occasional tables (except tops)*
- Ergonomic accessories (e.g. monitor arms, keyboard trays, wire management, desktop sit-to-stand, anti fatigue mats, power solutions)
- Screens
- Storage
- WFH products

Note: The tops for these products will have a minimum requirement of four units. Uni table ships in a single packet and the top is not subject to minimum four rule.

Minimums (Cont.)

3-UNIT MINIMUM:

- Lounge seating
- Tandem seating (Aviera)

Note: Products that do not require a minimum can be combined with those that require 3-unit minimum to reach the minimum quantity. If the minimum is not met, the order will incur a \$95 net surcharge per order.

4-UNIT MINIMUM:

- Tabletops/worksurfaces

Note: Tabletop/worksurface orders that don't reach the minimum of 4 tops will incur a \$95 net surcharge per order even if they're part of a larger order.

EXAMPLES

- Order A: 1 Rio chair, 1 Wit chair, 1 Gobi – no surcharge
- Order B: 1 Gobi, 1 Envoi - \$95 surcharge because the number of lounges is less than minimum 3 and there are no other products in the order
- Order C: 1 Aviera, 1 Mobio arm, 1 Motif screen – no surcharge
- Order D: 1 eBeam, 1 EON, 1 Switchback base, 1 Switchback top - \$95 surcharge because the number of tops is under the required four tops minimum
- Order E: 3 Switchback tables with tops - \$95 surcharge because the number of tops is under the required four tops minimum

Quantity Discounts

Quantity discounts for CAL 133 textiles and some shipping methods are available. See the appropriate Price Guide or contact Customer Experience for more information.

Change Orders

Orders that have been scheduled for production may not be changed. All changes on customer orders previously acknowledged must be requested in writing and are subject to approval. Requests for changes are not deemed accepted until acknowledged. In the event a revision is accepted, change fees may apply.

ORDERING INFORMATION

Lead Time

We have thousands of carded textiles—including vinyl and leather—that ship in two, five or 10 days. For a complete listing of textile lead times, see the Carded Textile Program section of the [Textile Reference Guide](#) or visit the [Materials tab](#) on our websites. Graded-in, COM and COL orders start production when the textile arrives from the manufacturer. Because of this the lead time on Motif screens or upholstered chairs is two, five or 10 days based on the textile selection.

TWO-DAY

- Anti-Fatigue Mat
- Corner Sleeve
- CPU Holders
- Current power
- High Tide
- Keyboard Mechanisms (Lift and Lock, Premium Lift and Lock, Sit-to-Stand)
- Keyboard Trays (Longboard, Crescent Board, Mini Platform, Laptop Tray, Adapter)
- Laptop Drawer
- Mobile Pedestals
- Monitor Arms
- Ocala Bases
- Pencil Storage
- Plastic Shells
- Switchback Bases
- Tensor Bases
- Value Lighting
- Voyager 2-Stage/3-Leg Bases
- Wire Management

THREE-DAY

- Doodle Screens
- Mobile Pedestal Cushions
- Modesty Screens
- Motif Screens
- Parallon Tables
- Prise Benching
- Sector Screens
- Standard Worksurfaces

10-DAY

- Lounge

15-DAY

- Stain-to-Match

21-DAY

- Tablet Arm

30-DAY

- Custom Laminate

Hold

Orders received by 10 a.m. PST begin assembly the next day. Orders that are “On Hold” will begin production only when all holds are released. Customer Experience will notify you of any holds placed on your order.

Types of holds include:

- Credit Hold for issues related to billing and invoicing.
- Incomplete Hold if the purchase order is incomplete or illegible.
- Pricing Hold if the price on the purchase order does not match the pricing shown in the Price Guide or in our computer system.
- New Fabric Hold for nonstandard textile orders without an inventory part number.
- Graded Hold is placed by the Purchasing Department while confirming delivery of graded fabric from the vendor.

Large Orders

Large orders may require additional lead time:

25 UNITS

- Cameo
- Composium
- Envoi
- Gobi
- Nano
- Sable
- Visit Modular

50 UNITS

- Aviera
- Benching
- Kindl
- Parallon Bases
- Screens
- Paséa
- Tabletops
- Tensor Bases

100 UNITS

- Flyte
- Sephen

150 UNITS

- Accessories
- Switchback Bases
- Lighting
- Monitor Arms
- Ocala Bases
- Power
- Sit-Stand (Desktop)
- Surge Bases

250 UNITS

- Task Chairs/Stools
- Side Chairs/Stools

ORDERING INFORMATION

Product Modification

Special requests are available and additional charges will be determined per quotation. Up to five working days are required after the special request is received to prepare a quotation. Contact Customer Experience for details.

Orders for Parts

Multiple shipments may occur for orders that include parts. Hardware such as casters or cylinders will ship separately from items requiring upholstery or manufacturing labor. Components such as casters or cylinders will ship separately from new chairs.

Product and Design Changes

We reserve the right to discontinue product lines, models and parts at any time. We also reserve the right to make changes in design and material when such action is deemed to be an improvement in design, function and/or construction.

Cancellation and Returns

Orders that have entered any stage of production cannot be canceled. Request for cancellations are not accepted until acknowledged. In the event a cancellation is accepted, canceled charges may be imposed for the entire amount of the order. Authorization for return must be requested from and approved by Customer Experience prior to the return of the merchandise. Returns may be subject to a restocking charge equivalent to 40% of the net order plus freight. Unauthorized returns will not be accepted.

Shipping

Standard shipments are made via common carrier, unless otherwise specified. Special routing requests or circumstances generated by the customer or the consignee may result in additional charges.

Additional surcharges are referred to as accessorial charges and can arise due to various factors that extend beyond the typical point-to-point transportation.

Examples of such surcharges may include but are not limited to fuel surcharges, residential delivery fees, liftgate services, inside delivery charges and re-delivery fees. Carriers also impose detention fees if the loading process takes longer than the allocated free time they allow. This fee compensates for the carrier's time and resources spent waiting.

Storage fees could also occur under certain circumstances and typically come into play when the consignee is unable to receive the goods promptly upon arrival at the destination. This delay may be due to reasons such as availability, scheduling conflicts, or other issues on the recipient's end. These fees are intended to cover the costs associated with keeping the items in storage, including warehouse space, security, and handling.

Each of these surcharges will vary depending on the carrier that is transporting the order. Please contact Customer Experience to ascertain exactly what these charges are or would be in any of the above circumstances.

Standard deliveries are dock to dock and are scheduled to occur Monday through Friday between 8 a.m. and 5 p.m.

If the delivery location has restricted delivery hours and cannot accept deliveries during normal business hours, Monday through Friday, 8 a.m. and to 5 p.m., this would require a smart delivery quote from Customer Experience. We will not be held responsible for issues or costs arising from carrier transit delays, missed delivery appointments, etc.

We reserve the right to charge for nonstandard customer delivery requirements that may include but are not limited to Residential, Lift Gate, Inside Delivery, Re-Delivery, Detention Fees (if the unloading process exceeds the standard allotted free time) and Storage.

ORDERING INFORMATION

Freight Terms

Freight terms apply to the continental U.S. only. This excludes Alaska and Hawaii. All standard transportation services and freight costs are included in the price of our products. We ship freight prepaid and allowed, FOB and origin.

Shipments outside the contiguous U.S. are shipped to the point of embarkation free of charge, if the shipment meets the minimum requirement. All subsequent freight charges will be at the customer's expense, shipped collect.

Because of the fluctuation of fuel prices, we reserve the right to impose fuel surcharges for any shipments.

Freight Damage

We are not responsible for product damage occurring in transit or during storage. Before accepting a shipment from the carrier, carefully review the packing list and inspect the quantity and condition of the items. Promptly document all visible damage on the Bill of Lading and request a carrier inspection of the product. In the event of damage, accept the order and contact Customer Experience for issue resolution. Concealed damage must be reported in writing within 60 days of accepting delivery. We will take all reasonable steps to assist customers in resolving claims for loss or damage.

Smart Delivery

Smart Delivery provides precise order delivery within a customer-specified date and time window. This special service is available in the contiguous U.S. and includes inside delivery, non-dock delivery, weekend delivery and residential delivery.

Requests must be made prior to an order being scheduled for production. A Smart Delivery fee will be added to the original order invoice. Any changes to a submitted Smart Delivery order will require a new Smart Delivery quote request. Not all change requests can be honored. Changes to an order will result in delays and/or additional costs once the order is in transit.

The Smart Delivery fee will be refunded if the shipment does not arrive within the specified delivery window. We will not be held responsible for costs or damages associated with delayed deliveries.

Please contact Customer Experience to request a Smart Delivery quote or for more information.

Will Call

Customers with Will Call orders will be notified once orders are ready to be picked up. Customers will have three business days from notification to pick up the order. If the order is not picked up within this time frame, storage charges will start at a rate of \$30 per business day until the order has been claimed.

Invoicing

Invoicing is triggered when the product ships.

Fire safety is a top priority for us. SitOnIt Seating strongly supports CAL 133 standards and makes it easy for designers and buyers to specify CAL 133 chairs.

TB 117

Under California law, all upholstered furniture must meet TB 117-2013 by January 1, 2015. At a minimum, all SitOnIt Seating fabrics, vinyl, leathers and resilient filling material (i.e., foam and Dacron) meet TB 117-2013. Unlike TB 117-2013, which tests only the inner upholstery components, with CAL 133 the entire piece of furniture must withstand ignition from a gas burner inside a testing chamber.

What is CAL 133?

CAL 133 is a standard of furniture flammability started by the California Bureau of Home Furnishings and Thermal Insulation for furniture used in public buildings such as healthcare facilities, convalescent homes, public assembly areas of hotels and motels, hospitals, board and care homes, stadiums, licensed child care facilities, prisons and jails.

Notice: Starting January 1, 2020, the State of California changed regulations to ban flame retardants in upholstered furniture sold in California. We anticipate further regulatory changes in other states. The TB-133 barrier material used in our products is a flame-retardant fabric designed to pass open-flame testing protocols. The cotton/fiberglass knit is infused with a phosphorus flame retardant and coated with a chemical that expands in heat to create a physical flame barrier. The TB-133 barrier material that we use in our products is free of halogenated flame retardants, polybrominated diphenyl ethers (PBDE), formaldehyde, and antimony.

Choosing CAL 133 Textiles

Consult the individual [SitOnIt Seating fabric cards](#) to review the specifications for each fabric offered. Because we offer such a vast array of fabrics with varying degrees of flame retardancy, we suggest you consult the published technical data of the fabric supplier when making your fabric selection.

Specify CAL 133 textiles in the Material section of the Final Price Calculation worksheet or on your purchase order.

SitOnIt Seating assumes no responsibility for the flame retardancy of any customer-provided textile.

CAL 133 Testing

CAL 133 is a full-scale fire test for furniture manufactured for use in public buildings. The standards do not specify how to construct furniture, but only how it should perform when tested. To pass this fire standard test, a fire blocking liner is sandwiched between the foam and the fabric of our chairs. This liner acts as a fire extinguisher by smothering the flame.

COM/COL compliance for the CAL 133 models listed on the following page can be determined by specifying upholstery with the exact characteristics as approved SitOnIt Seating fabrics and leathers or by conducting a full chair burn test. The nondiscountable test fee for each chair-textile combination is listed below. The lead time for testing is four weeks.

Task and Side Chairs/Stools: \$600
Lounge: \$800

For more information on TB 117-2013 and CAL 133, visit the [State of California Department of Consumer Affairs](#) website.

To Order CAL 133

Allow a 10-day lead time. Clearly specify CAL 133 on your order. For each chair, add the appropriate additional charge.

CAL 133 Materials

- **CAL 133 LEATHER:** All carded leather is CAL 133 approved.
- **CAL 133 TEXTILES:** Over a thousand CAL 133 approved textiles in all grades, colors and styles are listed on the SitOnIt Seating website. Visit sitonit.net and search textiles by CAL 133 compliance, manufacturer, grade, lead time and other attributes.

To Check Seating for CAL 133

To determine whether your current SitOnIt Seating chair meets CAL 133, or to check an order you have recently received, check the bottom of the chair seat pan for the label shown below. If your chair does not have this tag, your chair does not meet CAL 133.

NOTICE

This Article is manufactured for use in public occupancies and meets the flammability requirement of California Bureau of Home Furnishings technical bulletin 133. Care should be exercised near open flame or with burning cigarettes.

CAL 133 Approved Models

The following models, when combined with approved textiles and blocker, meet the CAL 133 standard.

MULTIPURPOSE CHAIRS AND STOOLS

- Achieve: Upholstered
- Anytime: Upholstered and all plastic colors - A48, A49 (arm and armless)
- Focus Side: Upholstered and all mesh colors - A130 (arm and armless)
- Freelance: Upholstered and all plastic colors (arm and armless)
- InFlex: Upholstered and all plastic colors: A121, A122 (arm and armless)
- Lumin: Upholstered and all plastic colors
- Mika: All models
- Movi: All mesh colors
- Non-Stop Heavy Duty: A67, A68, A69, A70, A71, A72 (arm and armless)
- OnCall: Upholstered and all plastic colors - A37FR, A42FR (arm and armless)
- Qwiz: All models
- ReAlign: A73, A74, A75, A76, A77 (arm and armless)
- Relay: Upholstered and all plastic colors - A60, A61 (arm and armless)
- Rio: Upholstered and all plastic colors (arm and armless)
- Rowdy: Upholstered and all plastic colors - A47 (arm and armless)
- Wit Side: All mesh colors (arm and armless)

CAL 133 Approved Models

TASK CHAIRS AND STOOLS

- Amplify: Upholstered and all mesh colors
- Focus: A91, A92, A93, A94, A95 (arm and armless)
- Knack: A77, A80, A81 (arm and armless)
- Mavic: All models
- Novo: All mesh colors (arm and armless)
- Prava: A105, A106, A108, A109, A111, A112 (arm and armless)
- Sona: A101, A102, A105, A106, A108, A109 and all knit colors (arm and armless)
- Torsa: All mesh colors (arm and armless)
- TR2: A12FR, A15FR, A17FR, A43FR, A44FR (arm and armless)
- Wit: All mesh colors (arm and armless)

LOUNGE SEATING

- Aviera: Metal and Wood
- Cameo
- Composium
- Envoi
- Gobi
- Nano
- Paséa
- Visit Modular

Unmatched Matching®

Textiles can be everything. With the right fabrics, you can provide atmosphere, create cohesiveness and offer an unforgettable experience across many spaces and places.

Fabric color, alignment, texture, orientation and pattern all play a part—and need to line up or match perfectly (especially with field-replaceable parts). With PatternMatch and pattern orientation, you can rest assured that every part of every chair can be traded out easily without disrupting design.

PatternMatch®

We ensure that design elements of the back, seat and arms match and/or align between seat and back. The patterns or lines also match unit-to-unit.

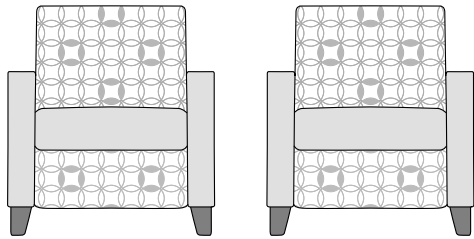

Pattern Orientation

All fabric (vertical, horizontal or bi-directional pattern) will be applied in the direction shown on the fabric manufacturer's website, unless otherwise specified.

To ensure desired fabric direction, use the Custom Upholstery Order Form on page 20 and check the appropriate box under the "Pattern Orientation" section.

When we apply a textile pattern with lines at a 90-degree angle (vertically and/or horizontally) to the back and seat of a chair, we strive to achieve full alignment. Some small variations can occur due to the shape and size of the product. Pattern Orientation is standard for SitOnIt Seating.

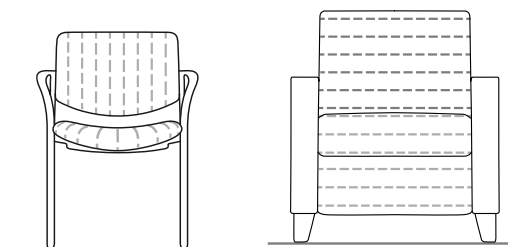

Multi-Upholstery

The multi-upholstery option allows one fabric to be selected for the back and a different fabric for the seat. Multi-upholstery lounge pricing is different than multi-upholstery pricing for task and side seating.

TASK AND SIDE

- Upholstery pricing is based on both seat and back being the same textile. If the material is COM/COL or more than one textile is used:

If two fabrics of the same grade are chosen,

one grade level will be added to the upholstery price.

Example: grade 4 for the seat and a different grade 4 for the back, the upholstery price will be grade 5 for both.

If two fabrics of different grades are chosen,

the final upholstery price will be based on the highest grade.

Example: grade 2 for the seat and grade 3 for the back, the upholstery price will be grade 3 for both.

The above upcharges only apply to chairs that have both the seat and back upholstered.

LOUNGE AND CORA

- A standard upcharge applies to all multi-upholstery orders. Different fabrics and grades may be combined because each back, seat, arm and valance are separately priced.
- Add the single multi-upholstery upcharge to the cost of the components. Example: upcharge + any grade price for the seat + any grade price for the back + any grade price for the arm.

Moisture Barrier

Accidents happen. To help protect your investment, moisture barrier for seats and backs is an option on all lounge seating products.

Specify moisture barrier seats and/or backs in the Material section of the Final Price Calculation worksheet or on your purchase order. Note that specification and pricing are separate for seat and back and apply to each single seat or back position.

COM/COL Warranty

Any textiles applied to furniture orders through the COM/COL process will not be covered under warranty by SitOnIt Seating. Any warranty claims for these upholstery materials will fall to the original vendor of the fabric. With a broad spectrum of harsh cleaning agents used by facilities, SitOnIt Seating recommends that the owner test each fabric selection with their specific cleaning methods before using. Additionally, SitOnIt Seating is not held responsible for receipt of defective fabrics, as we apply all COM as first-quality goods.

CAL 117 Policy

SitOnIt Seating assumes no responsibility for the fire retardancy of any COM/COL. Customers are solely responsible for making sure that their COM/COL complies with all applicable codes and regulations. For information on CAL 133, refer to page .

COM/COM Excess Yardage

SitOnIt Seating is not responsible for yardage submitted to us beyond the required amount. Excess COM/COL materials will be discarded at the discretion of SitOnIt Seating unless otherwise instructed by the customer at the time the order is placed. If a customer requires the COM/COL excess yardage returned, they must contact Customer Experience to make arrangements. The customer will be responsible for delivery charges.

COM/COL Process

1. Visit the [SitOnIt Seating Textile Compatibility](#) tab on our website to see if your COM/COL textile has already been approved.

(If your textile is already approved, skip to step 3. If it hasn't been previously approved, go to step 2.)
2. Send a 12" x 12" textile swatch to be tested for approval along with a completed COM/COL Test Request Form found on the next page.

Note: Cora, Freelance back, InFlex back, Focus Side back, Achieve back, Motif and all lounge products require 1 yard of fabric to be sent for testing.

Allow 3–5 business days once your textile is received for the test results to be available on the [SitOnIt Seating Textile Compatibility](#) tab on our website.

Send the textile swatch and form to:

SITONIT SEATING

Attn: COM Engineer

SO# _____ or Customer PO# _____

6280 Artesia Blvd.

Buena Park, CA 90620

(714) 995-4800

3. If the COM/COL swatch is approved, fill out the COM & Special Upholstery Form located on [page 20](#). and attach with your order.
4. Ship the necessary amount of COM or COL material to:

SITONIT SEATING

Attn: COM Engineer

SO# _____ or Customer PO# _____

6280 Artesia Blvd.

Buena Park, CA 90620

(714) 995-4800

COM/COL fabric must have an Exemplis SO# and/or Customer PO# labeled on it at the time of Receiving or it will delay the processing of the order.

5. Send carrier information and tracking number via email to sitonit@exemplis.com

COM/COL TEST REQUEST FORM

Please complete one form for each model and/or textile that needs to be tested.

Contact Information

Dealer _____ Contact Name _____
Address _____ City _____ State _____ Zip _____
Phone _____ Fax _____ Email _____

Product Information

Product Name _____ Model Number _____

Textile Information

Manufacturer _____ Pattern _____ Colorway _____

Shipping Information

The textiles and this form can be sent to:

SITONIT SEATING

Attn: COM Engineer

SO# _____ or Customer PO# _____

6280 Artesia Blvd.

Buena Park, CA 90620

(714) 995-4800

Please allow five business days once the fabric is delivered for your test results to be available on the [SitOnIt Seating Textile Compatibility](#) tab of our website. If you need further assistance, please contact Customer Experience at (888) 274-8664.

Note: Freelance back, InFlex back, and Focus Side back require 0.75 yards of fabric to be sent for testing. Lounge products and Achieve back require 1 yard. Motif requires 1.5 yards of fabric to be sent for testing.

COM & SPECIAL UPHOLSTERY FORM

For all COM/COL orders or orders with custom textile upholstery directions, please complete one form for each model and/or textile.

Contact Information

Dealer _____ Contact Name _____
 Address _____ City _____ State _____ Zip _____
 Phone _____ Fax _____ Email _____

Order Information

Purchase Order Number _____ Sales Order Number _____

Product Information

Product Name _____ Model Number _____ Quantity _____

Textile Information

Manufacturer _____ Pattern _____ Colorway _____

Total Yardage Calculated (for COM/COL) _____ Total Yardage Shipped (for COM/COL) _____

(To calculate, reference COM Calculation and COM Yardage Requirement beginning on page 22.)

Contains flame retardants: Yes No *Per California Proposition 65, we are required to note that select textiles may contain chemicals known to cause cancer or reproductive toxicity. To learn more, please visit the [Prop 65 web page](#).*
Prop 65 compliant: Yes No
PFAS compliant (AB1817): Yes No

Fabric Direction

To avoid confusion, you may wish to attach a sample textile with the desired face and direction indicated. Is there a desired top and bottom to the fabric application?

Yes No

Is the fabric either a stripe or two-color plaid?

Yes No

Please refer to our standard and rotated fabric directions to the right. Indicate the desired fabric direction for each applicable component below.

Seat (Ottoman Chassis): Vertical Horizontal
Back (Ottoman Top): Vertical Horizontal
Arm: Vertical Horizontal
Valance: Vertical Horizontal

Please attach this form with your order submission. If you are submitting a COM/COL order, make sure to include your PO# with the textile that you mail to our factory:

SITONIT SEATING

Attn: COM Engineer
 6280 Artesia Blvd., Buena Park, CA 90620

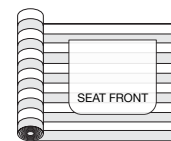
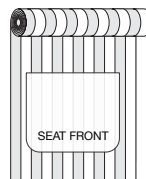

Vertical or Off the Roll

Horizontal or Railroaded

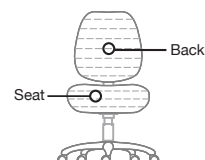
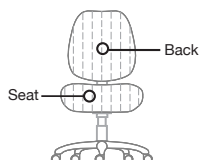
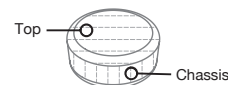
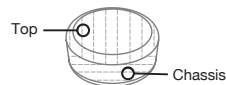
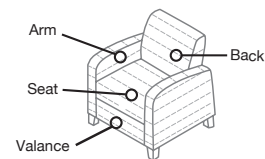
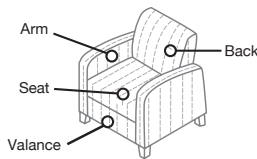

COM CALCULATION

Steps to Calculate COM Yardage.

1. Determine which products are being ordered as COM.
2. Find the yardage needed to upholster those products from the COM Yardage Requirement charts.
3. Adjust the yardage requirement total based on the repeat of the fabric roll using the COM Repeat Calculation table.
4. Take the final calculation and round up to the nearest half-yard to get final yardage.

For orders of 10 or more seats, contact Customer Experience for further quoting.

COM Repeat Calculation.

Use the guide below to calculate the percentage of extra upholstery required to cover large repeats.

Repeat	Railroaded/Horizontal OR Vertical/Off The Roll
5.1"– 7"	10%
7.1"–10"	15%
10.1"–14"	20%
14.1"–20"	30%
20.1"–27"	45%

Yardage requirements listed in this document are based on textile bolts/rolls that are 54" wide. Please contact Customer Experience if goods are a width other than 54".

COM Calculation Example

Below is a hypothetical scenario for how total COM yardage should be determined. This example is for a patterned textile that has a repeat.

STEP 1: DETERMINE WHICH PRODUCTS ARE BEING ORDERED AS COM

For this example order, we'll assume we need to order: 20 units of Freelance 4-leg—backs only.

STEP 2: DETERMINE THE COM YARDAGE REQUIREMENT

Looking at the COM Yardage Requirements chart that begins on [page 22](#), we see that the following yardage amounts are needed for each product:

Freelance 4-leg chair back = 0.94 yards.

Now we multiply 0.94 yards by the 20 chair backs and we get a total of 18.8 yards.

STEP 3: ADJUST THE YARDAGE REQUIREMENT TOTAL BASED ON REPEAT

Since the textile we've chosen is a pattern with a repeat, we should look at the COM Repeat Calculation table to determine our multiplier. For this example, let's assume our repeat is 11" and we're upholstering the fabric vertical/off-the-roll. Based on the table, the multiplier is 20%. Now, we need to take the 18.8 yards from step two and increase it by 20%. An easy way to calculate this is by multiplying 18.8 by 1.2, which gives us 22.6 yards.

STEP 4: ROUND TO GET THE FINAL AMOUNT NEEDED

To determine how much yardage is needed to complete this order, we take the amount from step three and round it to the nearest half-yard. In this case, that means the customer needs to send SitOnIt Seating 23 yards to complete this order.

COM/COL YARDAGE: TASK AND CONFERENCE

Combining upholstery is an option on all SitOnIt Seating upholstered products. Below are tables outlining the fabric or vinyl requirements for the entire chair as well as individual pieces. All yardage requirements are quoted in terms of yards for fabric or vinyl and square feet for leather. Please contact Customer Experience for order quantities greater than 10 seats.

Fabric or Vinyl (In Yardage)

Leather (In Square Feet)

	Fabric or Vinyl (In Yardage)			Leather (In Square Feet)		
	Seat and Back	Seat Only	Back Only	Seat and Back	Seat Only	Back Only
Amplify						
Midback Mesh	—	1	—	—	17	—
Highback Mesh	—	1	—	—	17	—
Highback Mesh Large and Tall	—	1.15	—	—	18	—
Highback Upholstered	1.25	1	0.9	23	17	15
Highback Upholstered Large and Tall	1.25	1.15	—	20	18	—
Midback Mesh Task Stool	—	1	—	—	17	—
Highback Upholstered Task Stool	1.25	1	0.9	23	17	15

Anytime

Light Task and Task Stool	1	0.8	0.75	15	10	8
---------------------------	---	-----	------	----	----	---

Focus

Midback Mesh	—	1	—	—	17	—
Highback Mesh	—	1	—	—	17	—
Midback Upholstered	1.15	1	0.75	23	17	15
Highback Upholstered	1.25	1	0.9	25	17	15
Highback Upholstered Large and Tall	1.25	1.15	—	31	25	—
Midback and Highback Mesh Task Stool	—	1	—	—	17	—
Midback and Highback Upholstered Task Stool	1.15	1	0.75	23	17	15

Focus 2.0

High Back Mesh	—	1	—	—	14	—
----------------	---	---	---	---	----	---

COM/COL YARDAGE: TASK AND CONFERENCE

Fabric or Vinyl (In Yardage)

Leather (In Square Feet)

	Seat and Back	Seat Only	Back Only	Seat and Back	Seat Only	Back Only
Glove						
Active Midback	2.4	1.16	1.18	50	20	25
Active Midback Ballistic Nylon	1.25	1.1	1.15	36	20	20
Active Highback	2.5	1.22	1.28	55	22	32
Active Highback Ballistic Nylon	1.4	1.15	1.2	42	21	22
Executive Midback	3.25	—	—	56	—	—
Executive Midback Ballistic Nylon	2.15	—	—	44	—	—
Executive Highback	3.5	—	—	70	—	—
Executive Highback Ballistic Nylon	2.35	—	—	57	—	—

Hexy

Task and Conference Chair	—	1	—	—	17	—
---------------------------	---	---	---	---	----	---

Inflex

Light Task and Task Stool	1	0.85	0.65	15	10	7
---------------------------	---	------	------	----	----	---

Ioniq

Light Task	—	0.75	—	—	7	—
------------	---	------	---	---	---	---

Knack

Midback	1.85	1	1.1	32	21	23
Midback Ballistic Nylon	1.55	1	1	27	21	15
Midback Task Stool	1.85	1	1.1	32	21	23
Midback Task Stool Ballistic Nylon	1.55	1	1	27	21	15

Lavo

Highback Task	—	1	—	—	18	—
---------------	---	---	---	---	----	---

Lumin

Light Task and Task Stool	1	0.85	0.65	15	10	7
---------------------------	---	------	------	----	----	---

Mavic

Midback Mesh	—	0.8	—	—	14	—
--------------	---	-----	---	---	----	---

COM/COL YARDAGE: TASK AND CONFERENCE

Fabric or Vinyl (In Yardage)

Leather (In Square Feet)

	Seat and Back	Seat Only	Back Only	Seat and Back	Seat Only	Back Only
--	---------------	-----------	-----------	---------------	-----------	-----------

Movi

Light Task and Task Stool		1		—	—	—
---------------------------	--	---	--	---	---	---

Non-Stop Heavy Duty

Size 1 Stool	1.75	1	1	30	18	20
Size 1 Stool Ballistic Nylon	1.3	1	1	22	18	12
Size 3	2.5	1	1.75	44	17	29
Size 3 Ballistic Nylon	2	1	1.25	35	17	20

Novo

Midback and Highback Mesh	—	1	—	—	17	—
Highback Mesh Large and Tall	—	1.15	—	—	18	—
Midback and Highback Mesh Stool	—	1	—	—	17	—

OnCall

Light Task and Task Stool	0.85	0.8	0.6	14	10	8
---------------------------	------	-----	-----	----	----	---

Orbix

Light Task and Task Stool	—	0.75	—	—	—	—
---------------------------	---	------	---	---	---	---

Prava

Midback	2	0.75	1.5	35	17	28
Highback	2.25	0.75	1.75	40	17	30

ReAlign

Midback	2	1	1.6	34	17	28
Midback Ballistic Nylon	1.7	1	1.25	30	17	21
Highback	2.2	1	1.65	40	17	25
Highback Ballistic Nylon	1.75	1	1.35	32	17	25
Midback Task Stool	2	1	1.6	34	17	28
Midback Task Stool Ballistic Nylon	1.7	1	1.25	30	17	21
Highback Task Stool	2.2	1	1.65	40	17	25
Highback Task Stool Ballistic Nylon	1.75	1	1.35	32	17	25

Relay

Light Task and Task Stool	1	0.75	0.6	15	12	10
---------------------------	---	------	-----	----	----	----

COM/COL YARDAGE: TASK AND CONFERENCE

Fabric or Vinyl (In Yardage)

Leather (In Square Feet)

	Seat and Back	Seat Only	Back Only	Seat and Back	Seat Only	Back Only
--	---------------	-----------	-----------	---------------	-----------	-----------

Rio

Light Task and Task Stool	1	0.85	0.65	15	10	7
---------------------------	---	------	------	----	----	---

Sephen

Lowback Conference	1.5	—	—	30	—	—
Highback Conference	2	—	—	35	—	—
Executive Back Conference	2.25	—	—	40	—	—

Sona

Midback Knit	—	1	—	—	17	—
Midback Upholstered	1.75	1	1.25	32	17	21

Torsa

Highback Mesh	—	1	—	—	17	—
---------------	---	---	---	---	----	---

TR2

Midback	1.5	1	0.9	25	18	18
Midback Ballistic Nylon	1.25	1	0.9	20	18	10
Executive	2	1.25	1.1	36	20	20
Executive Ballistic Nylon	1.7	1.25	1	30	20	15
Midback Task Stool	1.5	1	0.9	25	18	18
Midback Task Stool Ballistic Nylon	1.25	1	0.9	20	18	10

Vectra

Highback Mesh	—	1.1	—	—	20	—
---------------	---	-----	---	---	----	---

Wit

Midback/Highback	N/A	1	N/A	N/A	17	N/A
Midback/Highback Task Stool	N/A	1	N/A	N/A	17	N/A

COM/COL YARDAGE: MULTIPURPOSE AND SIDE

Combining upholstery is an option on all SitOnIt Seating upholstered products. Below are tables outlining the fabric or vinyl requirements for the entire chair as well as individual pieces. All yardage requirements are quoted in terms of yards for fabric or vinyl and square feet for leather. Please contact Customer Experience for order quantities greater than 10 seats.

	Fabric or Vinyl (In Yardage)			Leather (In Square Feet)		
	Seat and Back	Seat Only	Back Only	Seat and Back	Seat Only	Back Only

Achieve

Plastic Back	—	1	—	—	17	—
Upholstered Back	1.75	1	1	30	17	15

Anytime

Multipurpose	1	0.8	0.75	15	10	8
Bar Stool	1	0.8	0.75	15	10	8

Baja

Multipurpose	1	0.75	—	—	—	—
Bar Stool (Standard Back)	1	0.75	—	—	—	—
Bar Stool (Low Back)	0.75	0.75	—	—	—	—

Cora

Guest	1.25 yd	0.9 yd	0.75 yd	21 sq ft	14 sq ft	12 sq ft
Midsized	1.75 yd	1 yd	0.95 yd	27 sq ft	17 sq ft	15 sq ft
Bariatric	2 yd	1.25 yd	1.25 yd	30 sq ft	21 sq ft	18 sq ft

Flyte

Stacking Nester	1.25 yd	0.75 yd	—	—	—	—
-----------------	---------	---------	---	---	---	---

Focus Side

Multipurpose Mesh/Wood	—	1	—	—	17	—
Multipurpose Upholstered	1.25	1	0.75	20	12	10
Counter and Bar Stool Mesh/Wood	—	1	—	—	17	—
Counter and Bar Stool Upholstered	1.25	1	0.75	20	12	10

COM/COL YARDAGE: MULTIPURPOSE AND SIDE

Fabric or Vinyl (In Yardage)

Leather (In Square Feet)

	Seat and Back	Seat Only	Back Only	Seat and Back	Seat Only	Back Only
Freelance						
Multipurpose/Sled	1.25	0.99	1	25	15	—
Multipurpose/Sled Ballistic Nylon	1.15	0.99	0.9	21	15	—
Bariatric (30")	2.25	1	1.35	40	20	—
Bariatric (30") Ballistic Nylon	1.67	1	1	30	20	—
Bariatric (42")	2.5	1.25	1.5	42	25	—
Bariatric (42") Ballistic Nylon	1.75	1.25	1.25	40	25	—
Counter and Bar Stool	1.25	0.99	1	25	15	—
Counter and Bar Stool Ballistic Nylon	1.15	0.9	1	21	15	—

Inflex

Multipurpose	1	0.85	0.65	15	10	7
Counter and Bar Stool	1	0.85	0.65	15	10	7

Ioniq

Multipurpose Chair	—	0.75	—	—	7	—
Guest Chair	—	0.75	—	—	7	—

Lumin

Multipurpose	1	0.85	0.65	15	10	7
Wire Rod	1	0.85	0.65	15	10	7
Counter and Bar Stool	1	0.85	0.65	15	10	7

Mika

4-Leg	—	0.85	—	—	—	—
Wire Rod	—	0.85	—	—	—	—
Counter and Bar Stool	—	0.85	—	—	—	—

Movi

Nester	—	0.75	—	—	10	—
--------	---	------	---	---	----	---

OnCall

Multipurpose	0.85	0.8	0.6	14	10	8
Bar Stool	0.85	0.8	0.6	14	10	8

COM/COL YARDAGE: MULTIPURPOSE AND SIDE

Fabric or Vinyl (In Yardage)

Leather (In Square Feet)

	Seat and Back	Seat Only	Back Only	Seat and Back	Seat Only	Back Only
--	---------------	-----------	-----------	---------------	-----------	-----------

Orbix

Multipurpose	—	0.75	—	—	—	—
Bar Stool	—	0.75	—	—	—	—

Qwiz

Nester	1	0.75	—	—	—	—
--------	---	------	---	---	---	---

Relay

Multipurpose	1	0.75	0.6	15	12	10
Nester	1	0.75	0.6	15	12	10

Rio

Multipurpose	1	0.85	0.65	15	10	7
Wire Rod	1	0.85	0.65	15	10	7
Counter and Bar Stool	1	0.85	0.65	15	10	7

Rowdy

Wire Rod	—	0.75	—	—	13	—
----------	---	------	---	---	----	---

Wit Side

Multipurpose	—	0.75	—	—	10	—
--------------	---	------	---	---	----	---

COM/COL YARDAGE: LOUNGE

Combining upholstery is an option on all SitOnIt Seating upholstered products. Below are tables outlining the fabric or vinyl requirements for the entire chair as well as individual pieces. All yardage requirements are quoted in terms of yards for fabric or vinyl and feet for leather. Please contact Customer Experience for order quantities greater than 10 seats.

	Fabric or Vinyl (In Yardage)			Leather (In Square Feet)		
	Fully Upholstered	Seat Only	Back Only	Fully Upholstered	Seat Only	Back Only
Aviera						
Guest 21"	1.9	1.2	1.1	29.4	—	—
Guest 24"	1.9	1.2	1.6	43.4	—	—
Guest 30"	3.1	1.2	1.9	47.6	—	—
Guest 44"	3.4	1.6	1.9	50.4	—	—
Hip Chair	1.9	1.2	1.1	29.4	—	—
Patient 21"	2.8	1.2	1.9	35	—	—
Patient 24"	2.8	1.2	2.2	43.4	—	—
Patient 30"	3.8	1.2	2.5	50	—	—
Freespan 2-Seat 21"	3.8	1.9	2.1	58	—	—
Freespan 2-Seat 24"	4.3	2.2	3.1	86	—	—
Freespan 3-Seat 21"	5.6	3	3.1	88.2	—	—
Freespan 3-Seat 24"	5.9	3	4.7	93	—	—
Pre-Configured 2-Seat 21"	3.8	1.9	2.1	58	—	—
Pre-Configured 2-Seat 24"	4.3	2.2	3.1	86	—	—
Pre-Configured 3-Seat 21"	5.6	3	3.1	88.2	—	—
Pre-Configured 3-Seat 24"	5.9	3	4.7	93	—	—
Start/Center/End 21"	2.8	1.2	1.9	35	—	—
Start/Center/End 24"	2.8	1.2	2.2	43.4	—	—
Start/Center/End 30"	3.8	1.2	2.5	47.6	—	—
Start/Center/End 44"	3.4	1.6	1.9	50.4	—	—

COM/COL YARDAGE: LOUNGE

Fabric or Vinyl (In Yardage)

Leather (In Square Feet)

	Fully Upholstered	Seat Only	Back Only	Fully Upholstered	Seat Only	Back Only
Comeo						
Single Seat, Dual Arms	5	1.75	1.6	2.25	—	99
Single Seat, Right or Left Arm	4	1.75	1.6	1.25	—	78
Single Seat, Armless	3.25	1.75	1.6	—	—	63
Single Seat, Bench	2	2	—	—	—	36
2-Seater, Dual Arms	7.5	3.25	3	2.25	—	147
2-Seater, Right or Left Arm	6.5	3.25	3	1.25	—	126
2-Seater, Armless	5.75	3.25	3	—	—	115
2-Seater, Bench	3.75	3.75	—	—	—	68
3-Seater, Dual Arms	10.5	5	4.75	2.25	—	170
3-Seater, Right or Left Arm	9	5	4.75	1.25	—	150
3-Seater, Armless	8	5	4.75	—	—	130
3-Seater, Bench	5	5	—	—	—	84

Composium

Club Chair	5.3	1.9	2.2	3.8	1	83.3
Settee	7.9	3.2	4.1	3.8	1.3	122.5
Sofa	10.5	3.8	5.8	3.8	1.3	163.7
Ottoman	3.2	1.9	—	—	1.9	49
Bench, Single Seat	3.2	1.9	—	—	1.9	49
Bench, Double Seat	3.8	2.9	—	—	2.9	58.8
Bench, Triple Seat	4.4	2.9	—	—	2.9	68.6

Envoi

Midback Club Chair	3	1	2.5	—	—	50
Highback Club Chair	3.25	1	2.75	—	—	55

Envoi back yardage includes yardage for arms.

Gobi

Club Chair	3.5	2.8	1	—	—	55
------------	-----	-----	---	---	---	----

Gobi back yardage includes yardage for arms.

COM/COL YARDAGE: LOUNGE

Fabric or Vinyl (In Yardage)

Leather (In Square Feet)

	Fully Upholstered	Seat Only	Back Only	Fully Upholstered	Seat Only	Back Only
Nano						
Triangle	2	1	—	—	2	—
Diamond	3	1.5	—	—	2	—
Trapezoid	3.5	1.5	—	—	3	—
Boomerang	6.5	3	—	—	4	—

Paséa

Seat, Single	3	2	1.56	—		
Seat, 1½	4	2.5	1.75	—		
Seat, 90-Degree	5.25	2.75	3	—		
Seat, 120-Degree Inner or Outer	4.38	2.75	2.5	—		
Bench, Single	2	2	—	—		
Bench, 1½	2.5	2.5	—	—		
Bench, Right-Angled or Left-Angled	2.5	2.5	—	—		
Bench, 90° Corner	2.5	2.5	—	—		
Bench, 120° Bench	2.5	2.5	—	—		
Ottoman, Mini Round	1.75	1	—	—		
Ottoman, Mini Square	1.88	1	—	—		
Ottoman, Mini With Table Top	1.25	—	—	—		
Ottoman, Large Round	3.35	1.56	—	—		
Ottoman, Large Square	3.44	1.56	—	—		
Ottoman, Large With Table Top	2	—	—	—		

Sable

2-Seat Bench	4	—	—	70	—	—
3-Seat Bench	5	—	—	90	—	—
Club Chair	6	2.5	1.5	119	42	28
Settee	11	3	2.75	175	56	42
Sofa	14	4.25	4	230	75	60

Visit Modular

Ottoman	1.88	1.88	—	—	0.94	29.4
Club Chair, Armless	3.5	1.9	2.2	—	—	54.5
Club Chair, Upholstered Left or Right Arm	4.4	1.9	2.2	1.88	—	83.3
Club Chair, Upholstered Left and Right Arms	5.4	1.9	2.2	2.9	—	83.3
Club Chair, Wood Left or Right Arm	3.5	1.9	2.2	—	—	54.5
Club Chair, Wood Left and Right Arms	3.5	1.9	2.2	—	—	54.5

CUSTOM FINISH PROGRAM

Pricing

First-time custom stains must be approved before acceptance of an order. A one-time set-up fee applies. Thereafter, a stain-to-match upcharge is applied to each chair.

LOUNGE

One-time set-up fee: \$275

Stain-to-match upcharge: \$70 List

Ordering

When ordering, enter the approved STAIN ID# in the Material section of the Final Price Calculation worksheet or on your purchase order.

Custom Finish Terms and Conditions

Wood is inherently beautiful because of natural variations in color, grain and texture. There may be minor differences from one chair to the next, even though they are finished at the same time. We cannot guarantee exact matches of grain or natural wood color.

Approval Process

Since all new stains must be approved before they can be applied to seating or tables, allow extra time for custom finishes. Custom finishes generally require at least one to two weeks to create a matched sample. We will need a signed Approval Form before we can accept your order. We reserve the right to decline the opportunity to match a finish color.

1. Send a 3" x 4" or 4" x 6" sample of the stain, along with the model numbers and options to which the finish will be applied, to:

Customer Experience
Custom Finish Program
6415 Katella Avenue
Cypress, CA 90630

Include dealer name, contact and project reference.

2. Once approved, we will send a finish sample to you along with any caveats that may apply. We will keep an identical sample in our files for future orders. Custom finishes generally require at least a week to create a matched sample.
3. Carefully review the sample. Note the STAIN ID# (example: SM#070214-1); this will be needed for your order. Return the signed approval form to Customer Experience along with your order. We need your approval before we can accept the order, schedule it for production or acknowledge a ship date.
4. Lounge orders using our stain-to-match program will have a lead time of 15 days.

Chairs and Stools

TASK | LIGHT TASK | EXECUTIVE
CONFERENCE | COLLABORATIVE

Statement of Line

TASK | LIGHT TASK | EXECUTIVE CONFERENCE | COLLABORATIVE



Amplify Mesh
Midback Task Chair
2722 B1Page 38



Amplify Mesh
Highback Task Chair
2723 B1Page 38



Amplify Mesh
Midback Task Stool
2722 B3 S1/S2Page 42

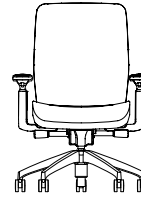

Amplify Upholstered
Highback Task Chair
2722 B1Page 46

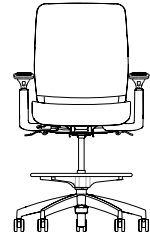

Amplify Upholstered
Highback Task Stool
2723 B3 S1/S2Page 50



Anytime
Light Task Chair
93TPage 53



Anytime
Light Task Stool
93T S1Page 53

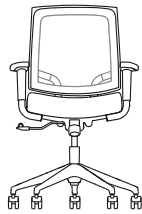

Focus Mesh
Midback Task Chair
5622 B1Page 56

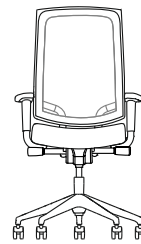

Focus Mesh
Highback Task Chair
5623 B1Page 56

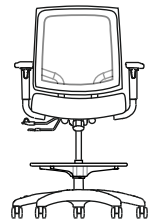

Focus Mesh
Midback Stool
5622 B1 S1/S2Page 61

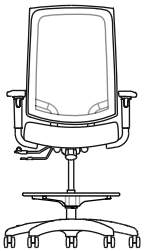

Focus Mesh
Highback Stool
5623 B1 S1/S2Page 61

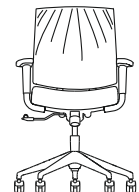

Focus Upholstered
Midback Task Chair
5622 B4Page 65

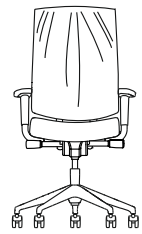

Focus Upholstered
Highback Task Chair
5623 B4Page 65

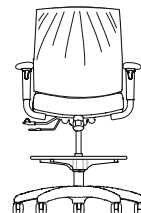

Focus Upholstered
Midback Task Stool
5622 B4 S1/S2Page 70

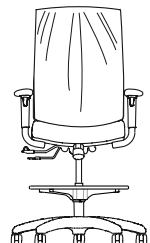

Focus Upholstered
Highback Task Stool
5623 B4 S1/S2Page 70



Focus 2.0
Midback Mesh Task Chair
1123 BK1Page 74

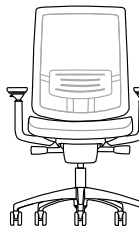

Focus 2.0
Highback Mesh Task Chair
1123 BK2Page 74



Focus 2.0
Midback Mesh Task Stool
1123 BK1 S1/S2Page 79

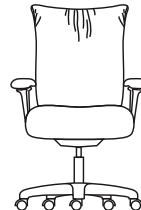

Glove Active
Midback Conference Chair
7531Page 83

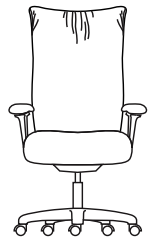

Glove Active
Highback Conference Chair
7532Page 83

Statement of Line

TASK | LIGHT TASK | EXECUTIVE CONFERENCE | COLLABORATIVE

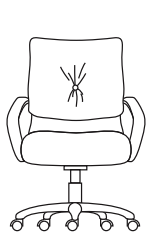

Glove Executive
Midback Conference Chair
7541.....Page 87

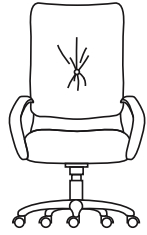

Glove Executive
Highback Executive Chair
7542.....Page 87

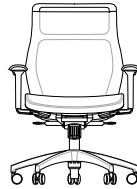

Hexy
Midback Mesh Task Chair
1203 BK1.....Page 90



Hexy
Highback Mesh Task Chair
1203 BK2.....Page 90



Hexy
Midback Mesh Task Stool
1203 BK1 S1/S2.....Page 94



InFlex
Light Task Chair
973.....Page 98

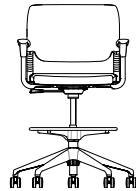

InFlex
Light Task Stool
973B S1/S2.....Page 98

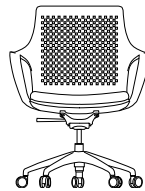

Ioniq
Collaborative Chair
1152 FT3.....Page 101



Knack
Midback Task Chair
3323.....Page 104



Knack
Midback Task Stool
3323 S1/S2.....Page 108

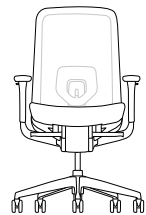

Lavo
Task Chair
1673 BK2.....Page 111

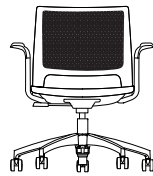

Lumin
Light Task Chair
1012 FT3.....Page 115



Lumin
Light Task Stool
1012 FT3 S21/S22.....Page 115



Mavic
Collaborative Chair
1113.....Page 119

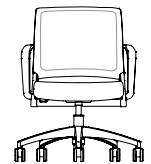

Movi
Light Task Chair
1062 FT3.....Page 122



Movi
Light Task Stool
1062 FT3 S21/S22.....Page 122

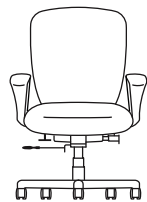

Non-Stop Heavy Duty XL
Heavy Duty Task Chair
673.....Page 126



Non-Stop Heavy Duty XL
Heavy Duty Task Stool
671 B2.....Page 129

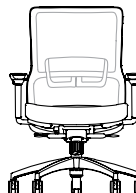

Novo
Midback Mesh Task Chair
1033 BK1.....Page 132

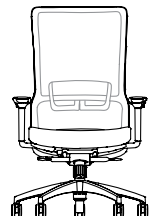

Novo
Highback Mesh Task Chair
1033 BK2.....Page 132

Statement of Line

TASK | LIGHT TASK | EXECUTIVE CONFERENCE | COLLABORATIVE

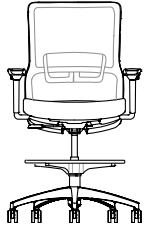

Novo
Midback Mesh Task Stool
1033 BK1 S1.....[Page 137](#)



OnCall
Light Task Chair
90T.....[Page 141](#)



OnCall
Light Task Stool
90TB S1/S2[Page 141](#)



Orbix
Light Task Chair
1132 FT3 CH1.....[Page 145](#)



Orbix
Light Task Stool
1132 FT3 S21/S22.....[Page 145](#)

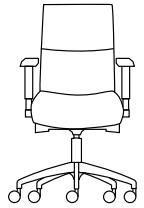

Prava
Midback Conference Chair
6422.....[Page 148](#)

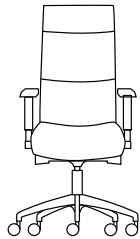

Prava
Highback Conference Chair
6423.....[Page 148](#)



ReAlign
Midback Task Chair
681.....[Page 152](#)

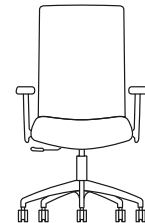

ReAlign
Highback Task Chair
682.....[Page 152](#)

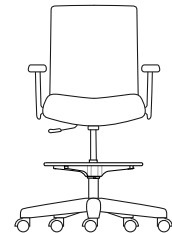

ReAlign
Midback Task Stool
681B[Page 157](#)

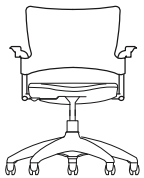

Relay
Light Task Chair
94T.....[Page 161](#)

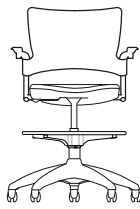

Relay
Light Task Stool
94B S1/S2[Page 161](#)

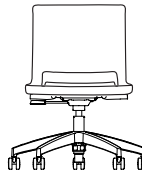

Rio
Light Task Chair
1052 FT3.....[Page 165](#)



Rio
Light Task Chair
1052 FT3 S21/S22.....[Page 165](#)



Sephen
Lowback Conference Chair
1664 BK3.....[Page 169](#)



Sephen
Highback Conference Chair
1664 BK2.....[Page 169](#)

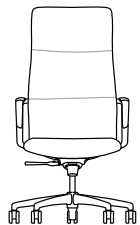

Sephen
Executive Back Conference Chair
1664 BK5.....[Page 169](#)

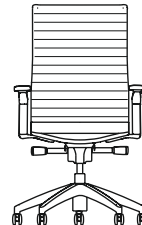

Sona
Knit Back Conference Chair
5723 B7[Page 172](#)

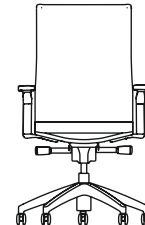

Sona
Upholstered Conference Chair
5723 B8[Page 172](#)

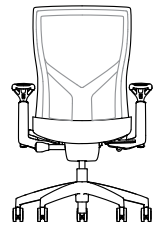

Torsa
Mesh Back Conference Chair
6023.....[Page 176](#)

Statement of Line

TASK | LIGHT TASK | EXECUTIVE CONFERENCE | COLLABORATIVE



TR2
Midback Task Chair
40.....Page 180



TR2
Highback Executive Chair
40EPage 180



TR2
Midback Task Stool
40 S1/S2.....Page 180

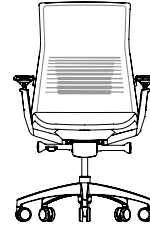

Vectra
Highback Mesh Task Chair
1073 BK2 MBPage 188

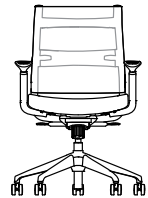

Wit Mesh
Midback Task Chair
2222 B1Page 192

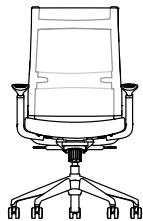

Wit Mesh
Highback Task Chair
2223 B1Page 192

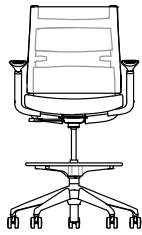

Wit Mesh
Midback Task Stool
2222 B1 S1/S2Page 196

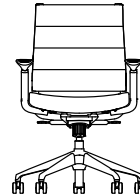

Wit Thintex
Midback Task Chair
2222 B9Page 200

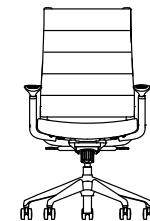

Wit Thintex
Highback Task Chair
2223 B9Page 200

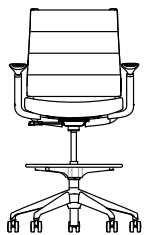

Wit Thintex
Midback Task Stool
2222 B9 S1/S2Page 204

Amplify

MESH BACK TASK CHAIR

The power of more.

The sleek, aerodynamic design gives Amplify™ power with the appearance of smart, no-nonsense efficiency and comfort. The supportive mesh back with adjustable lumbar support, three application-specific arm types and waterfall seat add great ergonomics and comfort to the equation. The eye-catching lumbar bands, curvaceous profile and soft, textured arm pads make this a chair that delivers style as well as substance.



Best
Featured with Aqua mesh and
SitOnIt Seating's Dash – Cloud

EFFECTIVE NOVEMBER 4, 2024

Featured Models

GOOD :: \$747

Midback, black frame, swivel-tilt mechanism, fixed arms, black nylon base, carpet casters, grade 1 textile

BETTER :: \$842

Highback, black frame, enhanced synchro mechanism, height-adjustable arms, black nylon base, carpet casters, grade 1 textile



BEST :: \$1,001

Highback, fog frame, enhanced synchro mechanism with seat-depth adjustment, multi-adjustable arms, fog nylon base, carpet casters, grade 1 textile

Features

- Midback or highback task chair
- Aerodynamic design
- Multiple frame, back support and arm color choices
- Adjustable lumbar support
- 10 bleach-cleanable mesh back colors
- Contrast stitching in 10 thread colors
- Enhanced synchro or swivel-tilt
- Waterfall seat
- Three arm styles with textured arm pads
- Black, fog or polished aluminum base
- Optional seat-depth adjustment
- Standard 300 lb weight capacity warranty;
Heavy Duty Series 400 lb weight capacity warranty

1. Back

Back Size and Style	Code	Price	
Midback Mesh With Adjustable Lumbar Support	2722 B1	\$807	
Highback Mesh With Adjustable Lumbar Support	2723 B1	\$842	

2. Heavy Duty

Heavy Duty Series	Code	Price	
Large and Tall (Black Highback Frame With Enhanced Synchro Y Mechanism and Sport Height-Adjustable Arms)	LT	+ \$400	

See the Super Duty Guide on [page 628](#) for additional LT and HD options.

MESH BACK TASK CHAIR

3. Mechanism

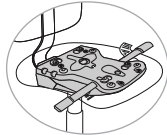
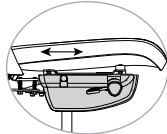
Mechanism Style	Code	Price	
Swivel-Tilt	T	- \$50	
Enhanced Synchro	Y	+ \$0	
Enhanced Synchro With Seat-Depth Adjustment	Y E3	+ \$79	

Seat-depth adjustment (E3) available with enhanced synchro (Y) mechanism only.





Better
Featured with Tangerine mesh and SitOnIt Seating's Dash — Dove

4. Frame

Frame Color	Code	Price	
Black	FC1	+ \$0	
Fog	FC13	+ \$45	

Frame color includes base, lumbar support band and arms.

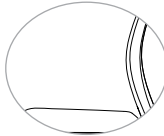
5. Arms

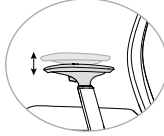
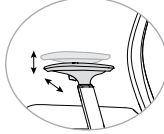
Arm Style	Code	Price	
Armless	A0	- \$45	
Fixed Polyurethane	A140	- \$10	
Height-Adjustable	A141	+ \$0	
Multi-Adjustable (Height/Width)	A142	+ \$35	



Arm color will match the frame. Arm pads are black except fixed polyurethane arm (A140) which matches frame color.

6. Base

Cylinder Height	Code	Price	
Standard Cylinder	S0	+ \$0	
Higher Cylinder	S13	+ \$0	

MESH BACK TASK CHAIR

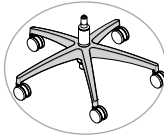
6. Base (Cont.)

Base Color and Material	Code	Price	
Black Nylon Base (For Black Frame FC1)	B17	+ \$0	
Fog Nylon Base (For Fog Frame FC13)	B21	+ \$0	
Polished Aluminum Base	B18	+ \$119	

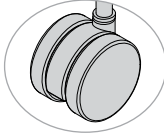
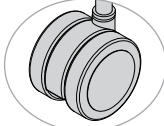
Casters or Glides	Code	Price	
Casters			
Black Carpet Casters	C16	+ \$0	
Black Hard Floor and Carpet Casters	C17	+ \$45	

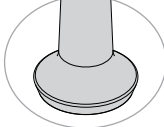
Glides			
Glides for Task Chairs	C3	+ \$35	

Nylon bases pair only with their corresponding frame color. Polished aluminum base (B18) can be used with all frame colors.

7. Material

Protection	Code	Price	
Fire Retardency			
CAL 133, Fabric, Quantities 1-49	133F	+ \$99	
CAL 133, Fabric, Quantities 50+	133F5	+ \$55	
CAL 133, Leather, Any Quantity	133L	+ \$119	

7. Material (Cont.)

Mesh Color	Code	Price
Apple	MC31	+ \$0
Aqua	MC30	+ \$0
Desert	MC9	+ \$0
Electric Blue	MC24	+ \$0
Fire	MC10	+ \$0
Fog	MC7	+ \$0
Navy	MC8	+ \$0
Nickel	MC6	+ \$0
Onyx	MC5	+ \$0
Tangerine	MC28	+ \$0
Seat Textile	Code	Price
Fabric/Vinyl Grade 1	FG1/VG1	+ \$0
COM	COM	+ \$30
Fabric/Vinyl Grade 2	FG2/VG2	+ \$30
Fabric/Vinyl Grade 3	FG3/VG3	+ \$60
Fabric/Vinyl Grade 4	FG4/VG4	+ \$116
Fabric/Vinyl Grade 5	FG5/VG5	+ \$172
Fabric/Vinyl Grade 6	FG6/VG6	+ \$213
Fabric/Vinyl Grade 7	FG7/VG7	+ \$254
Leather Grade 1	LG1	+ \$300
COL	COL	+ \$380
Leather Grade 2	LG2	+ \$380
Leather Grade 3	LG3	+ \$480
Contrast Stitching	Code	Price
No Contrast Stitching	TC0	+ \$0
Apple Thread	TC3	+ \$0
Desert Thread	TC9	+ \$0
Electric Blue Thread	TC4	+ \$0
Fire Thread	TC10	+ \$0
Fog Thread	TC7	+ \$0
Lemon Thread	TC2	+ \$0
Navy Thread	TC8	+ \$0
Nickel Thread	TC6	+ \$0
Onyx Thread	TC5	+ \$0
White Thread	TC1	+ \$0

Contrast stitching available only for SitOnIt Seating carded fabrics in solid colors.

Please reference the [Textile Reference Guide](#) for pricing on fabric over grade 7 and leather over grade 3. Additional CAL 133 information can be found on [page 15](#).

MESH BACK TASK CHAIR

8. Packaging

Packaging	Code	Price
Knocked Down	KD	+ \$0
Back Attached to Seat, Base Separate	UC	+ \$80
Fully Assembled in a Carton	AC	+ \$200

SPECIFICATIONS

	2722 B1 Midback Mesh Task Chair	2723 B1 Highback Mesh Task Chair	2723 B1 LT Large and Tall Task Chair
Dimensions			
Overall Width Without Arms	26"	26"	26"
Overall Width With Arms	27.75"-28.25"	27.75"-28.25"	29"
Overall Depth	24.5"	24.5"	29"
Overall Height	40"	43"	42"
Seat Width	19.25"	19.25"	22"
Seat Depth	17.5"-19.75"	17.5"-19.5"	17.5"-19.75"
Seat Height With Standard Base	16.88"-20.5" (T) 16.75"-20.25" (Y)	16.88"-20.5" (T) 16.75"-20.25" (Y)	N/A (T) 17.5"-21.5" (Y)
Seat Height With Higher Cylinder	17.5"-21.75" (T) 18.38"-22.63" (Y)	17.5"-21.75" (T) 18.38"-22.63" (Y)	N/A 20.5"-25" (Y)
Back Width	19.5"	19.5"	19.5"
Back Height	20.37"	23.37"	22"
Materials			
COM	1 yd	1 yd	1.15 yd
COL	17 sq ft	17 sq ft	18 sq ft
Weight and Capacity			
Weight Armless	32 lb	34 lb	44 lb
Weight With Arms	37 lb	39 lb	50 lb
Weight Capacity Warranty	300 lb	300 lb	400 lb

Swivel-tilt mechanism (T). Enhanced synchro mechanism (Y).

Amplify

MESH BACK TASK STOOL

The power of more.

The sleek, aerodynamic design gives Amplify™ power with the appearance of smart, no-nonsense efficiency and comfort. The supportive mesh back with adjustable lumbar support, three application-specific arm types and waterfall seat add great ergonomics and comfort to the equation.

The eye-catching lumbar bands, curvaceous profile and soft, textured arm pads make this a stool that delivers style as well as substance.



Best
Featured with Electric Blue mesh and
SitOnIt Seating's Spice — Caraway

EFFECTIVE NOVEMBER 4, 2024

Featured Models

GOOD :: \$852

Midback mesh, basic mechanism, black frame, armless, black nylon base, carpet casters, grade 1 textile

BETTER :: \$897

Midback mesh, basic mechanism, black frame, height-adjustable arms, black nylon base, carpet casters, grade 1 textile

BEST :: \$1,001

Midback mesh, basic mechanism, fog frame, multi-adjustable arms, extended stool kit, fog nylon base, carpet casters, grade 1 textile

Features

- Midback task stool
- Aerodynamic design
- Multiple frame, back support and arm color choices
- Adjustable lumbar support
- 10 bleach-cleanable mesh back colors
- Contrast stitching in 10 thread colors
- Waterfall seat
- Three arm styles with textured arm pads
- Black, fog or polished aluminum base
- Standard 300 lb weight capacity warranty

1. Back

Back Size and Style	Code	Price	
Midback Mesh Task Stool With Adjustable Lumbar Support	2722 B1	\$897	

2. Mechanism

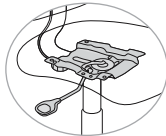
Mechanism Style	Code	Price	
Basic (Swivel Only)	B	+ \$0	



3. Frame

Frame Color	Code	Price	
Black	FC1	+ \$0	
Fog	FC13	+ \$45	

Frame color includes base, lumbar support band and arms.

MESH BACK TASK STOOL

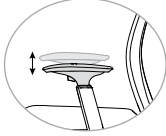
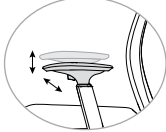

4. Arms

Arm Style	Code	Price	
Armless	A0	- \$45	
Fixed Polyurethane	A140	- \$10	
Height-Adjustable	A141	+ \$0	
Multi-Adjustable (Height/Width)	A142	+ \$35	

Arm color will match the frame. Arm pads are black except fixed polyurethane arm which matches frame color.

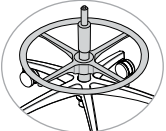
5. Base

Base	Code	Price	
Stool Kit	S1	+ \$0	
Extended Stool Kit	S2	+ \$24	

Base Color and Material	Code	Price	
Black Nylon Base (For Black Frame – FC1)	B17	+ \$0	
Fog Nylon Base (For Fog Frame – FC13)	B21	+ \$0	
Polished Aluminum Base	B18	+ \$119	

Nylon bases pair only with their corresponding frame color. Polished aluminum base (B18) can be used with all frame colors.

5. Base (Cont.)

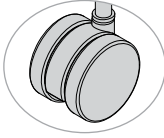
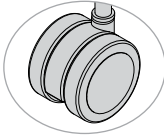
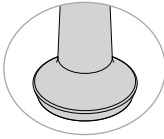
Casters or Glides	Code	Price	
Casters			
Black Carpet Casters	C16	+ \$0	
Black Hard Floor and Carpet Casters	C17	+ \$45	
Glides			
Glides for Task Chairs	C3	+ \$35	

6. Material

Protection	Code	Price	
Fire Retardancy			
CAL 133, Fabric, Quantities 1-49	133F	+ \$99	
CAL 133, Fabric, Quantities 50+	133F5	+ \$55	
CAL 133, Leather, Any Quantity	133L	+ \$119	
Mesh Color	Code	Price	
Apple	MC31	+ \$0	
Aqua	MC30	+ \$0	
Desert	MC9	+ \$0	
Electric Blue	MC24	+ \$0	
Fire	MC10	+ \$0	
Fog	MC7	+ \$0	
Navy	MC8	+ \$0	
Nickel	MC6	+ \$0	
Onyx	MC5	+ \$0	
Tangerine	MC28	+ \$0	

MESH BACK TASK STOOL

6. Material (Cont.)

Seat Textile	Code	Price	
Fabric/Vinyl Grade 1	FG1/VG1	+ \$0	
COM	COM	+ \$30	
Fabric/Vinyl Grade 2	FG2/VG2	+ \$30	
Fabric/Vinyl Grade 3	FG3/VG3	+ \$60	
Fabric/Vinyl Grade 4	FG4/VG4	+ \$116	
Fabric/Vinyl Grade 5	FG5/VG5	+ \$172	
Fabric/Vinyl Grade 6	FG6/VG6	+ \$213	
Fabric/Vinyl Grade 7	FG7/VG7	+ \$254	
Leather Grade 1	LG1	+ \$300	
COL	COL	+ \$380	
Leather Grade 2	LG2	+ \$380	
Leather Grade 3	LG3	+ \$480	
Contrast Stitching	Code	Price	
No Contrast Stitching	TC0	+ \$0	
Apple Thread	TC3	+ \$0	
Desert Thread	TC9	+ \$0	
Electric Blue Thread	TC4	+ \$0	
Fire Thread	TC10	+ \$0	
Fog Thread	TC7	+ \$0	
Lemon Thread	TC2	+ \$0	
Navy Thread	TC8	+ \$0	
Nickel Thread	TC6	+ \$0	
Onyx Thread	TC5	+ \$0	
White Thread	TC1	+ \$0	

Contrast stitching available only for SitOnIt Seating carded fabrics in solid colors.

Please reference the [Textile Reference Guide](#) for pricing on fabric over grade 7 and leather over grade 3. Additional CAL 133 information can be found on [page 15](#).

7. Packaging

Packaging	Code	Price	
Knocked Down	KD	+ \$0	
Back Attached to Seat, Base Separate	UC	+ \$80	
Fully Assembled in a Carton	AC	+ \$200	

MESH BACK TASK STOOL

SPECIFICATIONS

	2722 B1 S1 Task Stool	2722 B1 S2 Extended Task Stool
Dimensions		
Overall Width Armless	24.5"	24.5"
Overall Width With Arms	27.75"-28.25"	27.75"-28.25"
Overall Depth	24.5"	24.5"
Overall Height	39"-46.5"	43.75"-53.38"
Seat Width	19.25"	19.25"
Seat Depth	17.75"	17.75"
Seat Height	21.5"-29.5"	25"-35"
Back Width	19.5"	19.5"
Back Height	20.37"	20.37"
Materials		
COM	1 yd	1 yd
COL	17 sq ft	17 sq ft
Weight and Capacity		
Weight Armless	34 lb	35 lb
Weight With Arms	39.5 lb	40 lb
Weight Capacity	300 lb	300 lb



Good
Featured with Tangerine mesh and
SitOnIt Seating's Spice — Chai

Amplify

UPHOLSTERED BACK TASK CHAIR

The power of more.

In keeping with the aerodynamic design of the well-regarded Amplify™ mesh model, the Amplify upholstered chair's sleek and slender profile proves that this is a chair that delivers style as well as substance.



Best
Featured with SitOnIt Seating's Venice — Gold Dusk

EFFECTIVE NOVEMBER 4, 2024

Featured Models

GOOD :: \$890

Highback upholstered, black frame, swivel-tilt mechanism, fixed arms, black nylon base, carpet casters, grade 1 textile

BETTER :: \$950

Highback upholstered, black frame, enhanced synchro mechanism, height-adjustable arms, black nylon base, carpet casters, grade 1 textile

BEST :: \$1,109

Highback upholstered, fog frame, enhanced synchro mechanism with seat-depth adjustment, multi-adjustable arms, fog nylon base, carpet casters, grade 1 textile

Features

- Highback task chair
- Aerodynamic design
- Multiple frame, back support and arm color choices
- Adjustable lumbar support
- Enhanced synchro or swivel-tilt
- Waterfall seat
- Three arm styles with textured arm pads
- Black, fog, silver or polished aluminum base
- Optional seat-depth adjustment
- Standard 300 lb weight capacity warranty;
Heavy Duty Series 400 lb weight capacity warranty



Good
Featured with SitOnIt Seating's Venice — Mainstream

UPHOLSTERED BACK TASK CHAIR

1. Back

Back Size and Style	Code	Price	
Highback Upholstered With Dynamic Lumbar	2723 B3	\$950	

2. Heavy Duty

Heavy Duty Series	Code	Price	
Large and Tall (Black Highback Frame With Enhanced Synchro Y Mechanism and Sport Height-Adjustable Arms)	LT	+ \$400	

See the Super Duty Guide on [page 16](#) for additional LT and HD options.

2. Mechanism

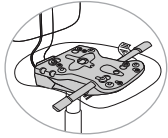
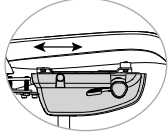
Mechanism Style	Code	Price	
Swivel-Tilt	T	- \$50	
Enhanced Synchro	Y	+ \$0	
Enhanced Synchro With Seat-Depth Adjustment	Y E3	+ \$79	

Seat-depth adjustment (E3) is not available on swivel-tilt (T) mechanism.

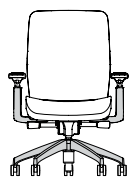

3. Frame

Frame Color	Code	Price	
Black, Single-Color Nylon Frame	FC1	+ \$0	
Fog, Single-Color Nylon Frame	FC13	+ \$45	
Fog With Silver, Two-Color Nylon Frame	FC14	+ \$45	

Single-color nylon frame includes base, back support and arms.

Two-color nylon frame includes fog frame with silver back support and silver base. Adjustable arms are silver. Fixed arms are fog.

4. Arms

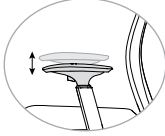
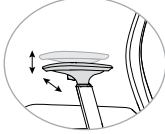
Arm Style	Code	Price	
Armless	A0	- \$45	
Fixed Polyurethane	A140	- \$10	
Height-Adjustable	A141	+ \$0	
Multi-Adjustable (Height/Width)	A142	+ \$35	

Arm color will match the frame. Arm pads are black except fixed polyurethane arm which matches frame color.

5. Base

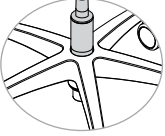
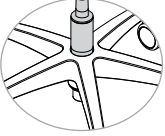
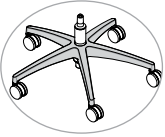
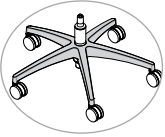
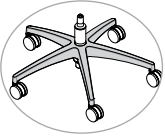
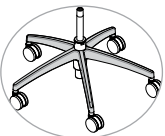
Cylinder Height	Code	Price	
Standard Cylinder	S0	+ \$0	
Higher Cylinder	S13	+ \$0	
Base Color and Material	Code	Price	
Black Nylon Base (For Black Frame FC1)	B17	+ \$0	
Fog Nylon Base (For Fog Frame FC13)	B21	+ \$0	
Silver Nylon Base (For Fog Frame With Silver FC14)	B22	+ \$0	
Polished Aluminum Base	B18	+ \$119	

Nylon bases pair only with their corresponding frame color. Polished aluminum base (B18) can be used with all frame colors.

UPHOLSTERED BACK TASK CHAIR

6. Base (Cont.)

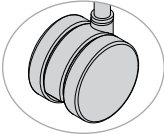
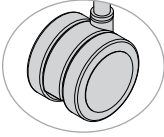
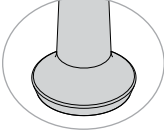
Casters or Glides	Code	Price	
Casters			
Black Carpet Casters	C16	+ \$0	
Black Hard Floor and Carpet Casters	C17	+ \$45	
Glides			
Glides for Task Chairs	C3	+ \$35	

7. Material

Protection	Code	Price	
Fire Retardancy			
CAL 133, Fabric, Quantities 1-49	133F	+ \$99	
CAL 133, Fabric, Quantities 50+	133F5	+ \$55	
CAL 133, Leather, Any Quantity	133L	+ \$119	
Seat and Back Textile	Code	Price	
Fabric/Vinyl Grade 1	FG1/VG1	+ \$0	
COM	COM	+ \$40	
Fabric/Vinyl Grade 2	FG2/VG2	+ \$40	
Fabric/Vinyl Grade 3	FG3/VG3	+ \$74	
Fabric/Vinyl Grade 4	FG4/VG4	+ \$121	
Fabric/Vinyl Grade 5	FG5/VG5	+ \$174	
Fabric/Vinyl Grade 6	FG6/VG6	+ \$235	
Fabric/Vinyl Grade 7	FG7/VG7	+ \$296	
Leather Grade 1	LG1	+ \$320	
COL	COL	+ \$420	
Leather Grade 2	LG2	+ \$420	
Leather Grade 3	LG3	+ \$540	

Please reference the [Textile Reference Guide](#) for pricing on fabric over grade 7 and leather over grade 3. Additional CAL 133 information can be found on [page 15](#).

Please reference the [Fabric information](#) found on [page 17](#) for pricing on multi-upholstery.

UPHOLSTERED BACK TASK CHAIR

8. Packaging

Packaging	Code	Price
Knocked Down	KD	+ \$0
Back Attached to Seat, Base Separate	UC	+ \$80
Fully Assembled in a Carton	AC	+ \$200

SPECIFICATIONS

2723 B3 Highback Upholstered Task Chair	
Dimensions	
Overall Width Armless	26"W
Overall Width With Arms	27.75"
Overall Depth	24.5"
Overall Height	42"
Seat Width	19.25"
Seat Depth	17.5"-19.5"
Seat Height With Standard Cylinder (S0)	16.5"-20.12" (T) 16.5"-20.35" (Y)
Seat Height With Higher Cylinder (S13)	17.5"-21.87" (T) 18"-22.5" (Y)
Back Width	19.5"
Back Height	23.37"
Materials	
COM	1.25 yd
COL	23 sq ft
Weight and Capacity	
Weight Armless	35 lb
Weight With Arms	40 lb
Weight Capacity	300 lb

Swivel tilt mechanism (T). Enhanced synchro mechanism (Y).



Better
Featured with SitOnIt Seating's
Huntington – Tropical

Amplify

UPHOLSTERED BACK TASK STOOL

The power of more.

In keeping with the aerodynamic design of the well-regarded Amplify™ mesh model, the Amplify upholstered chair's sleek and slender profile proves that this is a stool that delivers style as well as substance.



Best
Featured with SitOnIt Seating's Venice — Sundown

EFFECTIVE NOVEMBER 4, 2024

Featured Models

GOOD :: \$995

Highback upholstered, basic mechanism, black frame, armless, black nylon base, carpet casters, grade 1 textile

BETTER :: \$1,040

Highback upholstered, basic mechanism, black frame, height-adjustable arms, black nylon base, carpet casters, grade 1 textile

BEST :: \$1,144

Highback upholstered, basic mechanism, fog frame, multi-adjustable arms, extended stool kit, fog nylon base, carpet casters, grade 1 textile

Features

- Highback task stool
- Aerodynamic design
- Multiple frame, back support and arm color choices
- Adjustable lumbar support
- Waterfall seat
- Three arm styles with textured arm pads
- Black, fog or polished aluminum base
- Standard 300 lb weight capacity warranty

1. Back

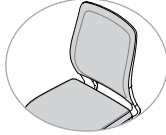
Back Size and Style	Code	Price	
Highback Upholstered Task Stool With Dynamic Lumbar	2723 B3	\$1,040	

2. Mechanism

Mechanism Style	Code	Price	
Basic (Swivel Only)	B	+ \$0	

3. Frame

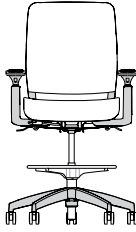

Frame Color	Code	Price	
Black, Single-Color Nylon Frame	FC1	+ \$0	
Fog, Single-Color Nylon Frame	FC13	+ \$45	
Fog With Silver, Two-Color Nylon Frame	FC14	+ \$45	

Single-color frame includes base, lumbar support band and arms.

Two-color frame includes fog frame with silver back support and silver base. Adjustable arms are silver. Fixed arms are fog.



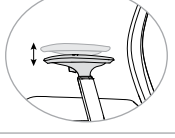
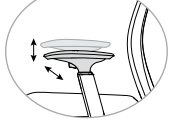

UPHOLSTERED BACK TASK STOOL

4. Arms

Arm Style	Code	Price	
Armless	A0	- \$45	
Fixed Polyurethane	A140	- \$10	
Height-Adjustable	A141	+ \$0	
Multi-Adjustable (Height/Width)	A142	+ \$35	

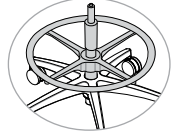
Arm color will match the frame. Arm pads are black except fixed polyurethane arm (A140) which matches frame color.

5. Base

Base	Code	Price	
Stool Kit	S1	+ \$0	
Extended Stool Kit	S2	+ \$24	
Base Color and Material	Code	Price	
Black Nylon Base (For Black Frame FC1)	B17	+ \$0	
Fog Nylon Base (For Fog Frame FC13)	B21	+ \$0	
Silver Nylon Base (For Fog Frame With Silver FC14)	B22	+ \$0	
Polished Aluminum Base	B18	+ \$119	

5. Base (Cont.)

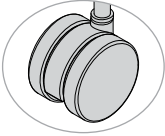
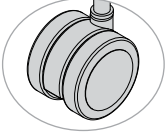
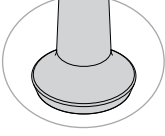
Casters or Glides	Code	Price	
Casters			
Black Carpet Casters	C16	+ \$0	
Black Hard Floor and Carpet Casters	C17	+ \$45	
Glides			
Glides for Task Chairs	C3	+ \$35	

Nylon bases pair only with their corresponding frame color. Polished aluminum base (B18) can be used with all frame colors.

6. Material

Protection	Code	Price	
Fire Retardancy			
CAL 133, Fabric, Quantities 1–49	133F	+ \$99	
CAL 133, Fabric, Quantities 50+	133F5	+ \$55	
CAL 133, Leather, Any Quantity	133L	+ \$119	
Seat and Back Textile	Code	Price	
Fabric/Vinyl Grade 1	FG1/VG1	+ \$0	
COM	COM	+ \$40	
Fabric/Vinyl Grade 2	FG2/VG2	+ \$40	
Fabric/Vinyl Grade 3	FG3/VG3	+ \$74	
Fabric/Vinyl Grade 4	FG4/VG4	+ \$121	
Fabric/Vinyl Grade 5	FG5/VG5	+ \$174	
Fabric/Vinyl Grade 6	FG6/VG6	+ \$235	
Fabric/Vinyl Grade 7	FG7/VG7	+ \$296	
Leather Grade 1	LG1	+ \$320	
COL	COL	+ \$420	
Leather Grade 2	LG2	+ \$420	
Leather Grade 3	LG3	+ \$540	

Please reference the [Textile Reference Guide](#) for pricing on fabric over grade 7 and leather over grade 3. Additional CAL 133 information can be found on [page 15](#).

Please reference the [Fabric information](#) found on [page 17](#) for pricing on multi-upholstery.

UPHOLSTERED BACK TASK STOOL

7. Packaging

Protection	Code	Price	
Knocked Down	KD	+ \$0	
Back Attached to Seat, Base Separate	UC	+ \$80	
Fully Assembled in a Carton	AC	+ \$200	

SPECIFICATIONS

	2723 B3 S1 Task Stool	2723 B3 S2 Extended Task Stool
Dimensions		
Overall Width Armless	24.5"	24.5"
Overall Width With Arms	27.75"–28.25"	27.75"–28.25"
Overall Depth	24.5"	24.5"
Overall Height	40.75"–48.25"	45.5"–55.13"
Seat Width	19.25"	19.25"
Seat Depth	17.75"	17.75"
Seat Height	21.5"–29.5"	25"–35"
Back Width	19.5"	19.5"
Back Height	22"	22"
Materials		
COM	1.25 yd	1.25 yd
COL	23 sq ft	23 sq ft
Weight and Capacity		
Weight Armless	35.5 lb	36 lb
Weight With Arms	40.5 lb	41 lb
Weight Capacity Warranty	300 lb	300 lb

Anytime

LIGHT TASK CHAIR AND STOOL

*Grab and go.
Anywhere.*

The Anytime™ light task chair and stool pair perfectly with the Anytime side chair to make a complete set. Featuring the versatility that is the signature of the collection along with a perforated shell and a built-in pull handle, Anytime makes any office, meeting or training room a workspace.



*Good
Featured witha Navy shell*

Featured Models

GOOD :: \$512

Task chair, all plastic, basic mechanism, armless, carpet casters

BETTER :: \$592

Task chair, plastic back and upholstered seat, swivel-tilt mechanism, armless, carpet casters



BEST :: \$715

Task chair, fully upholstered, swivel-tilt mechanism, fixed arms, carpet casters

Features

- Features
- Light task chair and light task stool
- Fully upholstered, upholstered seat only or plastic
- Three plastic colors
- Perforated shell provides ventilation
- Built-in pull handle
- Black tubular frame
- 250 lb weight capacity
- Complements Anytime multipurpose chair and bar stool; see [page 215](#)

1. Back

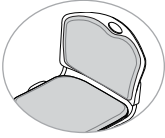
Seat and Back Style	Code	Price	
Plastic	No Code	\$527	
Upholstered Seat Only	US	\$592	
Upholstered Seat and Back	UP	\$657	

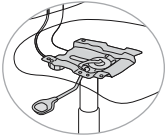
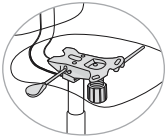

2. Mechanism

Mechanism Style	Code	Price	
Basic (Swivel Only)	B	- \$15	
Swivel-Tilt	T	+ \$0	



Swivel-tilt mechanism (T) is not available for task stool (S1) or extended task stool (S2).

LIGHT TASK CHAIR AND STOOL

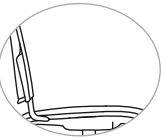

3. Frame

Frame Type	Code	Price	
Task Chair	93T	+ \$0	
Task Stool	93T S1	+ \$150	
Extended Task Stool	93T S2	+ \$174	

4. Arms

Arm Style	Code	Price	
Armless	A0	+ \$0	
Fixed Loop Arms	A48	+ \$58	

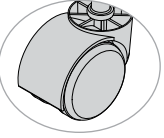
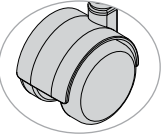
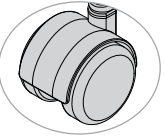
5. Base

Casters and Glides	Code	Price	
Casters			
Carpet Casters	C6	+ \$0	
Hard Floor and Carpet Casters	C1	+ \$40	
Self-Locking Carpet Casters	C2	+ \$30	
Self-Locking Hard Floor and Carpet Casters	C7	+ \$61	

Self-locking casters (C2/C7) lock only when not in use.

5. Base (Cont.)

Casters and Glides	Code	Price
Glides		
Glides for Task Chairs	C3	+ \$30

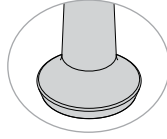

6. Material

Protection	Code	Price
Fire Retardancy		
CAL 133, Fabric, Quantities 1–49	133F	+ \$99
CAL 133, Fabric, Quantities 50+	133F5	+ \$55
CAL 133, Plastic, Any Quantity	133P	+ \$45
Shell Color	Code	Price
Black	SC1	+ \$0
Navy	SC5	+ \$0
Slate	SC8	+ \$0
Textile	Code	Price
Seat Textile Only (For US)		
Fabric/Vinyl Grade 1	FG1/VG1	+ \$0
COM	COM	+ \$24
Fabric/Vinyl Grade 2	FG2/VG2	+ \$24
Fabric/Vinyl Grade 3	FG3/VG3	+ \$45
Fabric/Vinyl Grade 4	FG4/VG4	+ \$77
Fabric/Vinyl Grade 5	FG5/VG5	+ \$116
Fabric/Vinyl Grade 6	FG6/VG6	+ \$159
Fabric/Vinyl Grade 7	FG7/VG7	+ \$200
Textile	Code	Price
Seat and Back Textile (For UP)		
Fabric/Vinyl Grade 1	FG1/VG1	+ \$0
COM	COM	+ \$36
Fabric/Vinyl Grade 2	FG2/VG2	+ \$36
Fabric/Vinyl Grade 3	FG3/VG3	+ \$74
Fabric/Vinyl Grade 4	FG4/VG4	+ \$121
Fabric/Vinyl Grade 5	FG5/VG5	+ \$174
Fabric/Vinyl Grade 6	FG6/VG6	+ \$235
Fabric/Vinyl Grade 7	FG7/VG7	+ \$296

Please reference the [Textile Reference Guide](#) for pricing on fabric over grade 7 and leather over grade 3. Additional CAL 133 information can be found on [page 15](#).
Please reference the [Fabric information](#) found on [page 17](#) for pricing on multi-upholstery.

LIGHT TASK CHAIR AND STOOL

7. Packaging

Packaging	Code	Price
Back Attached to Seat, Base Separate	UC	+ \$0
Fully Assembled in a Carton	AC	+ \$120

SPECIFICATIONS

	93T Task	93T S1 Task Stool	93T S2 Extended Task Stool
Dimensions			
Overall Width Armless	26"	26"	26"
Overall Width With Arms	26.5"	26.5"	26.5"
Overall Depth	26"	26"	26"
Overall Height	35.5"	39"	43"
Seat Width	19"	19"	19"
Seat Depth	18"	18"	18"
Seat Height	16"-21"	19.6"-27"	23.5"-33.5"
Back Width	21.5"	21.5"	21.5"
Back Height	14.5"	14.5"	14.5"
Materials			
COM	0.8 yd (US) 1 yd (UP)	0.8 yd (US) 1 yd (UP)	0.8 yd (US) 1 yd (UP)
Weight and Capacity			
Weight Armless	29.5 lb	39.5 lb	39.5 lb
Weight With Arms	33.4 lb	44.4 lb	44.4 lb
Weight Capacity Warranty	250 lb	250 lb	250 lb

Focus

MESH BACK TASK CHAIR

Where comfort, style and ergonomics converge.

Experience something so comfortable it hardly ever crosses your mind—from the moment you sit down until it's time to head home. Our bestselling seating solution works just about anywhere you need thanks to a wider back frame, extra-deep seat and almost endless options to customize.

Our signature dual-curve frame takes its cues from modern, industrial design while also reinforcing key points of contact, so your back is optimally supported throughout the day.



Best
Featured with Freeway mesh and
SitOnIt Seating's Spice – Fire.

EFFECTIVE NOVEMBER 4, 2024

Featured Models

GOOD :: \$783

Midback, swivel-tilt mechanism, height-adjustable arms, nylon base, grade 1 textile

BETTER :: \$868

Highback, enhanced synchro mechanism, height-adjustable arms, nylon base, grade 1 textile

BEST :: \$1,077

Highback, adjustable lumbar, enhanced synchro mechanism with seat-depth adjustment, fully multi-adjustable (10-way) sport arms, nylon base, grade 1 textile

Features

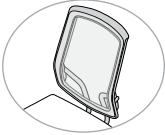
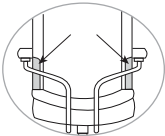

- Ergonomic back support and comfort
- Midback and highback
- Looser-weave mesh for extra breathability
- Five bleach-cleanable mesh colors
- Adjustable lumbar option
- Nine ergonomic arm styles with standard or sport arm pads
- Black or silver accents
- Waterfall seat
- Optional sport casters
- Complements Focus 2.0 task chair and Focus Side chair, counter and bar stool; see [page 74](#) and [page 234](#)
- Standard 300 lb weight capacity warranty; Super Duty Series: 350 lb and 400 lb weight capacity options

1. Back

Back Size and Style	Code	Price	
Midback Mesh	5622 B1	\$833	
Highback Mesh	5623 B1	\$868	
Back Options	Code	Price	
Adjustable Lumbar Support	LB1	+ \$50	



MESH BACK TASK CHAIR

2. Super Duty

Super Duty Series	Code	Price	
Heavy Duty	HD	+ \$200	
Large and Tall (Black Highback Frame With Enhanced Synchro Y Mechanism and Sport Height-Adjustable A152 Arms)	LT	+ \$400	

Heavy duty model (HD) is only available with enhanced synchro (Y) mechanism. Heavy Duty model (HD) is not available with fixed arms (A91). See the Super Duty Guide on [page 626](#) for additional LT and HD options.

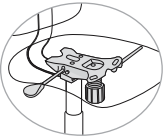
3. Mechanism

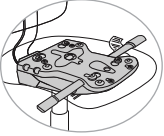
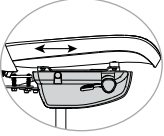
Mechanism Style	Code	Price	
Swivel-Tilt	T	- \$50	
Knee-Tilt	K	- \$17	
Enhanced Synchro	Y	+ \$0	
Enhanced Synchro Seat-Depth Adjustment	Y E3	+ \$79	

4. Frame

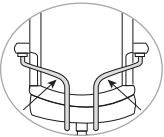
Back Support Color	Code	Price	
Black	Z1	+ \$0	
Silver	Z2	+ \$20	



5. Arms

Arm Style	Code	Price	
Armless	A0	- \$45	
Fixed Arms	A91	- \$10	
Height-Adjustable	A92	+ \$0	
Height-Adjustable With Sport Arm Pads	A152	+ \$0	
Height-/Width-Adjustable	A93	+ \$35	
Height-/Width-Adjustable With Sport Arm Pads	A153	+ \$35	
Fully Adjustable (6-Way)	A94	+ \$70	
Fully Adjustable (6-Way) With Sport Arm Pads	A154	+ \$70	
Fully Multi-Adjustable (10-Way)	A95	+ \$80	
Fully Multi-Adjustable (10-Way) With Sport Arm Pads	A155	+ \$80	

Fixed arms (A91) not available with enhanced synchro (Y) mechanism.

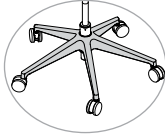
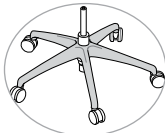
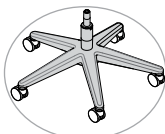

MESH BACK TASK CHAIR

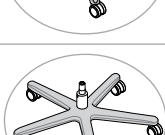
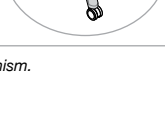
6. Base

Base Color and Style	Code	Price	
Black Nylon	B0	+ \$0	
High Profile Polished Aluminum Base	B3	+ \$119	
High Profile Brushed Aluminum Base	B8	+ \$119	
Low Profile Base With Higher Cylinder	S8	+ \$0	
Heavy Duty Bases (For HD/LT)			
Black Nylon Base, 26"	B7	+ \$0	
Polished Aluminum Base	B5	+ \$169	

Low profile base (S8) only available with enhanced synchro (Y) mechanism.

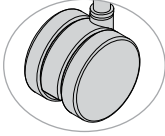
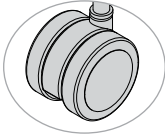
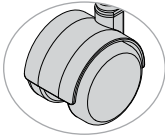
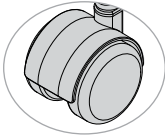
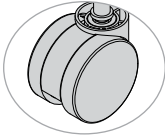
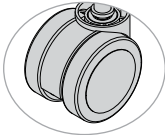
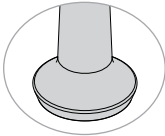
6. Base (Cont.)

Casters or Glides	Code	Price	
Casters			
Carpet Casters	C15	+ \$0	
Sport Carpet Casters	C31	+ \$0	
Sport Hard Floor and Carpet Casters	C32	+ \$45	
Hard Floor and Carpet Casters	C14	+ \$45	
Self-Locking Carpet Casters	C20	+ \$30	
Self-Locking Hard Floor and Carpet Casters	C19	+ \$64	
Heavy Duty Casters (For HD and LT)			
Heavy Duty Carpet Casters	C11	+ \$0	
Heavy Duty Hard Floor and Carpet Casters	C9	+ \$61	
Glides			
Glides for Task Chairs	C3	+ \$35	

Self-locking casters (C19/C20) lock only when not in use.

MESH BACK TASK CHAIR

7. Material

Protection	Code	Price	
Fire Retardancy			
CAL 133, Fabric, Quantities 1-49	133F	+ \$99	
CAL 133, Fabric, Quantities 50+	133F5	+ \$55	
CAL 133, Leather, Any Quantity	133L	+ \$119	
Mesh Color			
Black	MC1	+ \$0	
Sand	MC3	+ \$0	
Slate	MC2	+ \$0	
Freeway Sport Stripe (Black/Slate)	MC33	+ \$0	
Impress Sport Stripe (Slate/Black)	MC34	+ \$0	
Seat Textile			
Fabric/Vinyl Grade 1	FG1/VG1	+ \$0	
COM	COM	+ \$30	
Fabric/Vinyl Grade 2	FG2/VG2	+ \$30	
Fabric/Vinyl Grade 3	FG3/VG3	+ \$60	
Fabric/Vinyl Grade 4	FG4/VG4	+ \$116	
Fabric/Vinyl Grade 5	FG5/VG5	+ \$172	
Fabric/Vinyl Grade 6	FG6/VG6	+ \$213	
Fabric/Vinyl Grade 7	FG7/VG7	+ \$254	
Leather Grade 1	LG1	+ \$300	
COL	COL	+ \$380	
Leather Grade 2	LG2	+ \$380	
Leather Grade 3	LG3	+ \$480	

Sport striped meshes list the predominant color first.

Please reference the [Textile Reference Guide](#) for pricing on fabric over grade 7 and leather over grade 3. Additional CAL 133 information can be found on [page 15](#).

8. Packaging

Packaging	Code	Price	
Knocked Down	KD	+ \$0	
Back Attached to Seat, Base Separate	UC	+ \$80	
Fully Assembled In a Carton	AC	+ \$200	

EFFECTIVE NOVEMBER 4, 2024 | GSA SIN #: 33721

SPECIFICATIONS

	5622 B1 Midback Mesh Task Chair	5623 B1 Highback Mesh Task Chair	5623 B1 LT Highback Mesh Large and Tall Task Chair
Dimensions			
Overall Width Armless	26"	26"	26"
Overall Width With Arms	27.3"	27.5"	29"
Overall Depth	25"	26"	29"
Overall Height	35" 35.5" (B3/B8)	39" 39.5" (B3/B8)	38" (B7), 39" (B5)
Seat Width	19"	19"	22"
Seat Depth	18.5"-20.75"	18.5"-20.75"	17.5"
Seat Height	16.5"-20.125" (T) 17.5"- 20.5" (K) 16.75"-20.75" (Y)	16.5"-20.125" (T) 17.5"-20.5" (K) 16.75"-20.75" (Y)	16.75"-19.75" (Y/B7) 16.88"-20.25" (Y/B5)
Back Width	18.25"	18.3"	18.3"
Back Height	20"	23.5"	21.5"
Materials			
COM	1 yd	1 yd	1.15 yd
COL	17 sq ft	17 sq ft	25 sq ft
Weight and Capacity			
Weight Armless	35.5 lb	36.5 lb	47 lb
Weight With Arms	41.5 lb	42.5 lb	53 lb
Weight Capacity	300 lb	300 lb	400 lb
Warranty	350 lb (HD)	350 lb (HD)	

Swivel-tilt mechanism (T). Knee-tilt mechanism (K). Enhanced synchro mechanism (Y). High profile polished aluminum base (B3). High profile brushed aluminum base (B8). Heavy Duty (HD). Heavy Duty black nylon base (B7). Heavy duty polished aluminum base (B5).



Better
Featured with Sand mesh and
SitOnIt Seating's Venice – Gold Dusk.

Focus

MESH BACK TASK STOOL

Where comfort, style and ergonomics converge.

Experience something so comfortable it hardly ever crosses your mind—from the moment you sit down until it's time to head home. Our bestselling seating solution works just about anywhere you need thanks to a wider back frame, extra-deep seat and almost endless options to customize.

Our signature dual-curve frame takes its cues from modern, industrial design while also reinforcing key points of contact, so your back is optimally supported throughout the day.



Best
Featured with Impress mesh and
SitOnIt Seating's Huntington – Tropical

EFFECTIVE NOVEMBER 4, 2024

Featured Models

GOOD :: \$878

Midback mesh task stool, basic mechanism, armless, nylon base, grade 1 textile

BETTER :: \$958

Highback mesh task stool, basic mechanism, height-adjustable arms, nylon base, grade 1 textile

BEST :: \$1,112

Highback mesh task stool with adjustable lumbar support, basic mechanism, 10-way arms with sport pads, extended stool kit, nylon base, grade 1 textile



FOCUS

EFFECTIVE NOVEMBER 4, 2024 | GSA SIN #: 33721

Features

- Ergonomic back support and comfort
- Midback and highback
- Looser-weave mesh for extra breathability
- Five bleach-cleanable mesh colors
- Adjustable lumbar option
- Nine ergonomic arm styles with standard or Sport arm pads
- Black or silver accents
- Waterfall seat
- Optional Sport casters
- Complements Focus 2.0 task chair and Focus Side chair, counter and bar stool; see [page 74](#) and [page 234](#)
- Standard 300 lb weight capacity warranty

1. Back

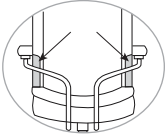
Back Size and Style	Code	Price	
Midback Mesh	5622 B1	\$923	
Highback Mesh	5623 B1	\$958	
Back Options	Code	Price	
Adjustable Lumbar Support	LB1	+ \$50	

MESH BACK TASK STOOL

2. Mechanism

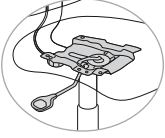
Mechanism Style	Code	Price	
Basic (Swivel Only)	B	+\$0	

3. Frame

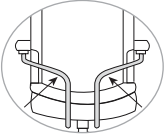
Back Support Color	Code	Price	
Black	Z1	+\$0	
Silver	Z2	+\$20	





Good
Featured with Slate mesh and
SitOnIt Seating's Malibu – Ruby

4. Arms

Arm Style	Code	Price	
Armless	A0	- \$45	
Fixed Arms	A91	- \$10	
Height-Adjustable	A92	+ \$0	
Height-Adjustable With Sport Arm Pads	A152	+ \$0	
Height-/Width-Adjustable	A93	+ \$35	
Height-/Width-Adjustable With Sport Arm Pads	A153	+ \$35	
Fully Adjustable (6-Way)	A94	+ \$70	
Fully Adjustable (6-Way) With Sport Arm Pads	A154	+ \$70	
Fully Multi-Adjustable (10-Way)	A95	+ \$80	
Fully Multi-Adjustable (10-Way) With Sport Arm Pads	A155	+ \$80	

MESH BACK TASK STOOL

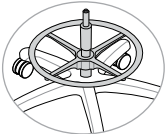
5. Base

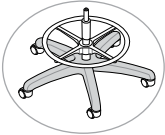
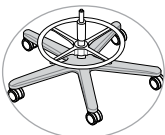
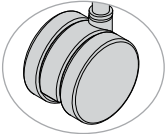
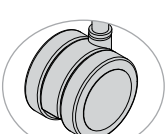
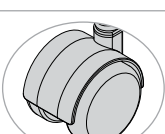
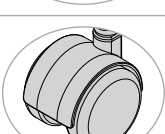
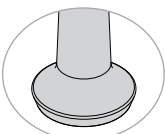
Base	Code	Price	
Stool Kit	S1	+ \$0	
Extended Stool Kit	S2	+ \$24	
Base Color and Material	Code	Price	
Black Nylon Base	B6	+ \$0	
Polished Aluminum Base	B5	+ \$169	
Casters or Glides	Code	Price	
Casters			
Carpet Casters	C5	+ \$0	
Carpet Casters (For Higher Cylinder)	C21	+ \$0	
Sport Carpet Casters	C31	+ \$0	
Sport Hard Floor and Carpet Casters	C32	+ \$45	
Hard Floor and Carpet Casters	C1	+ \$45	
Hard Floor and Carpet Casters (For Higher Cylinder)	C22	+ \$45	
Self-Locking Carpet Casters	C2	+ \$30	
Self-Locking Hard Floor and Carpet Casters	C7	+ \$61	
Glides			
Glides for Task Chairs	C3	+ \$35	

Self-locking casters (C2/C7) lock only when not in use.

6. Material

Protection	Code	Price
Fire Retardancy		
CAL 133, Fabric, Quantities 1–49	133F	+ \$99
CAL 133, Fabric, Quantities 50+	133F5	+ \$55
CAL 133, Leather, Any Quantity	133L	+ \$119

Mesh Color	Code	Price
Black	MC1	+ \$0
Sand	MC3	+ \$0
Slate	MC2	+ \$0
Freeway Sport Stripe (Black/Slate)	MC33	+ \$0
Impress Sport Stripe (Slate/Black)	MC34	+ \$0

Seat Textile	Code	Price
Fabric/Vinyl Grade 1	FG1/VG1	+ \$0
COM	COM	+ \$30
Fabric/Vinyl Grade 2	FG2/VG2	+ \$30
Fabric/Vinyl Grade 3	FG3/VG3	+ \$60
Fabric/Vinyl Grade 4	FG4/VG4	+ \$116
Fabric/Vinyl Grade 5	FG5/VG5	+ \$172
Fabric/Vinyl Grade 6	FG6/VG6	+ \$213
Fabric/Vinyl Grade 7	FG7/VG7	+ \$254
Leather Grade 1	LG1	+ \$300
COL	COL	+ \$380
Leather Grade 2	LG2	+ \$380
Leather Grade 3	LG3	+ \$480

Sport striped meshes list the predominant color first.

Please reference the [Textile Reference Guide](#) for pricing on fabric over grade 7 and leather over grade 3. Additional CAL 133 information can be found on [page 15](#).

7. Packaging

Packaging	Code	Price
Knocked Down	KD	+ \$0
Back Attached to Seat, Base Separate	UC	+ \$80
Fully Assembled in a Carton	AC	+ \$200

MESH BACK TASK STOOL

MIDBACK SPECIFICATIONS

	5622 B1 S1 Midback Task Stool	5622 B1 S2 Midback Extended Task Stool
Dimensions		
Overall Width Armless	27.3"	27.3"
Overall Width With Arms	27.3"	27.3"
Overall Depth	25"	25"
Overall Height	41.6"	46"
Seat Width	19"	19"
Seat Depth	18.5"	18.5"
Seat Height	21"–29"	24"–34"
Back Width	18.25"	18.25"
Back Height	20"	20"
Materials		
COM	1 yd	1 yd
COL	17 sq ft	17 sq ft
Weight and Capacity		
Weight Armless	39.5 lb	40.5 lb
Weight With Arms	45.5 lb	46.5 lb
Weight Capacity Warranty	300 lb	300 lb

HIGHBACK SPECIFICATIONS

	5623 B1 S1 Highback Task Stool	5623 B1 S2 Highbackw Extended Task Stool
Dimensions		
Overall Width Armless	20"	20"
Overall Width With Arms	27.5"	27.5"
Overall Depth	26"	26"
Overall Height	45"	50"
Seat Width	20"	20"
Seat Depth	18.5"	18.5"
Seat Height	21"–29"	24"–34"
Back Width	18.3"	18.3"
Back Height	23.5"	23.5"
Materials		
COM	1 yd	1 yd
COL	17 sq ft	17 sq ft
Weight and Capacity		
Weight Armless	40.5 lb	41.5 lb
Weight With Arms	46.5 lb	47.5 lb
Weight Capacity Warranty	300 lb	300 lb

Focus

UPHOLSTERED BACK TASK CHAIR

Where comfort, style and ergonomics converge.

Experience something so comfortable it hardly ever crosses your mind—from the moment you sit down until it's time to head home. Our bestselling seating solution works just about anywhere you need thanks to a wider back frame, extra-deep seat and almost endless options to customize.

Our signature dual-curve frame takes its cues from modern, industrial design while also reinforcing key points of contact, so your back is optimally supported throughout the day.



*Best
Featured with SitOnIt Seating's
Malibu – Orange*

EFFECTIVE NOVEMBER 4, 2024

Featured Models

GOOD :: \$909

Midback upholstered pad, swivel-tilt mechanism, height-adjustable arms, nylon base, carpet casters, grade 1 textile

BETTER :: \$994

Highback upholstered pad, enhanced synchro mechanism, height-adjustable sport arm pads, nylon base, carpet casters grade 1 textile



BEST :: \$1,203

Highback upholstered pad, adjustable lumbar, enhanced synchro mechanism with seat-depth adjustment, fully multi-adjustable (10-way) sport arm pads, nylon base, carpet casters, grade 1 textile

Features

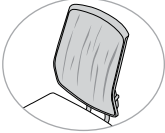

- Ergonomic back support and comfort
- Midback and highback
- Relaxed-fit upholstered pad
- Adjustable lumbar support
- Nine ergonomic arm styles with standard or Sport arm pads
- Black or silver accents
- Waterfall seat
- Optional Sport casters
- Complements Focus 2.0 task chair and Focus Side chair, counter and bar stool; see [page 74](#) and [page 234](#)
- Standard 300 lb weight capacity warranty; Heavy Duty Series - 350 lb and 400 lb weight capacities

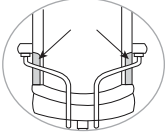
1. Back

Back Size and Style	Code	Price	
Midback Relaxed-Fit Upholstered Pad	5622 B4	\$959	
Highback Relaxed-Fit Upholstered Pad	5623 B4	\$994	
Back Options	Code	Price	
Adjustable Lumbar Support	LB1	+ \$50	



UPHOLSTERED BACK TASK CHAIR

2. Heavy Duty

Heavy Duty Series	Code	Price	
Heavy Duty	HD	+ \$200	
Large and Tall (Black Highback Frame With Enhanced Synchro Y Mechanism and Sport Height-Adjustable A152 Arms)	LT	+ \$400	

Heavy Duty model (HD) only available with enhanced synchro (Y) mechanism. See [page 626](#) for additional options Heavy Duty and Large and Tall options.

3. Mechanism

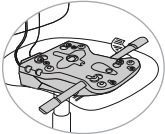
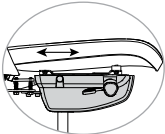
Mechanism	Code	Price	
Swivel-Tilt	T	- \$50	
Knee-Tilt	K	- \$17	
Enhanced Synchro	Y	+ \$0	
Enhanced Synchro With Seat-Depth Adjustment	Y E3	+ \$79	

4. Frame

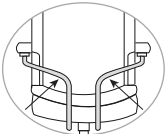
Back Support Color	Code	Price	
Black	Z1	+ \$0	
Silver	Z2	+ \$20	





5. Arms

Arm Style	Code	Price	
Armless	A0	- \$45	
Fixed Arms	A91	- \$10	
Height-Adjustable	A92	+ \$0	
Height-Adjustable With Sport Arm Pads	A152	+ \$0	
Height-/Width-Adjustable	A93	+ \$35	
Height-/Width-Adjustable With Sport Arm Pads	A153	+ \$35	
Fully Adjustable (6-Way)	A94	+ \$70	
Fully Adjustable (6-Way) With Sport Arm Pads	A154	+ \$70	
Fully Multi-Adjustable (10-Way)	A95	+ \$80	
Fully Multi-Adjustable (10-Way) With Sport Arm Pads	A155	+ \$80	

Fixed arms (A91) are not available with the enhanced synchro (Y) mechanism.

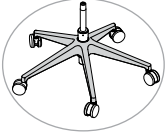
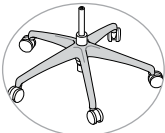
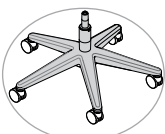
UPHOLSTERED BACK TASK CHAIR

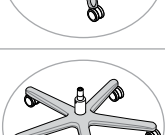
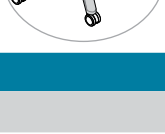
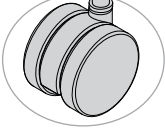
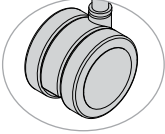
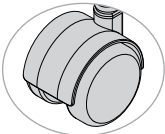
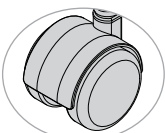
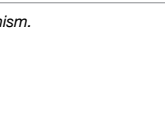
6. Base

Base and Color	Code	Price	
Black Nylon Base	B0	+ \$0	
High Profile Polished Aluminum Base	B3	+ \$119	
High Profile Brushed Aluminum Base	B8	+ \$119	
Low Profile Nylon Base With Higher Cylinder	S8	+ \$0	
Heavy Duty Bases (For HD/LT)			
Black Nylon Base, 26"	B7	+ \$0	
Polished Aluminum	B5	+ \$169	
Casters or Glides	Code	Price	
Casters			
Carpet Casters	C15	+ \$0	
Sport Carpet Casters	C31	+ \$0	
Sport Hard Floor and Carpet Casters	C32	+ \$45	
Hard Floor and Carpet Casters	C14	+ \$45	
Self-Locking Carpet Casters	C20	+ \$30	
Self-Locking Hard Floor and Carpet Casters	C19	+ \$64	

Low profile base (S8) only available with enhanced synchro (Y) mechanism.
Heavy Duty bases (B5/B7) are for use with the HD and LT models.

6. Base (Cont.)

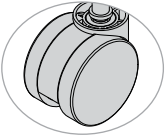
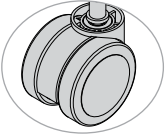
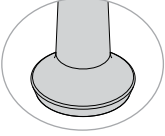
Casters or Glides	Code	Price	
Heavy Duty Casters (For HD and LT)			
Heavy Duty Carpet Casters	C11	+ \$0	
Heavy Duty Hard Floor and Carpet Casters	C9	+ \$61	
Glides			
Glides for Task Chairs	C3	+ \$35	

Self-locking casters (C20/C19) lock only when not in use.

7. Material

Protection	Code	Price	
Fire Retardancy			
CAL 133, Fabric, Quantities 1-49	133F	+ \$99	
CAL 133, Fabric, Quantities 50+	133F5	+ \$55	
CAL 133, Leather, Any Quantity	133L	+ \$119	
Seat and Back Textile	Code	Price	
Fabric/Vinyl Grade 1	FG1/VG1	+ \$0	
COM	COM	+ \$40	
Fabric/Vinyl Grade 2	FG2/VG2	+ \$40	
Fabric/Vinyl Grade 3	FG3/VG3	+ \$74	
Fabric/Vinyl Grade 4	FG4/VG4	+ \$121	
Fabric/Vinyl Grade 5	FG5/VG5	+ \$174	
Fabric/Vinyl Grade 6	FG6/VG6	+ \$235	
Fabric/Vinyl Grade 7	FG7/VG7	+ \$296	
Leather Grade 1	LG1	+ \$320	
COL	COL	+ \$420	
Leather Grade 2	LG2	+ \$420	
Leather Grade 3	LG3	+ \$540	

Please reference the [Textile Reference Guide](#) for pricing on fabric over grade 7 and leather over grade 3. Additional CAL 133 information can be found on [page 15](#).

Please reference the [Fabric](#) information found on [page 17](#) for pricing on multi-upholstery.

UPHOLSTERED BACK TASK CHAIR

8. Packaging

Base and Color and Material	Code	Price	
Knocked Down	KD	+ \$0	
Back Attached to Seat, Base Separate	UC	+ \$80	
Fully Assembled in a Carton	AC	+ \$200	



Better
Featured with SitOnIt Seating's
Venice - Gold Dusk

EFFECTIVE NOVEMBER 4, 2024 | GSA SIN #: 33721

SPECIFICATIONS

	5622 B4 Midback Task Chair	5623 B4 Highback Task Chair	5623 B4 LT Large and Tall Task Chair
Dimensions			
Overall Width Armless	26"	26"	26"
Overall Width With Arms	27.3"	27.5"	29"
Overall Depth	25"	26"	27.75"
Overall Height	35" (B0), 35.5" (B3/B8)	39" (B0), 39.5" (B3/B8)	38.5" (B7), 39.75" (B5)
Seat Width	19"	19"	22"
Seat Depth	18.5"-20.75"	18.5"-20.75"	17.5"
Seat Height	16.5"-20.125" (T) 17.5"-20.5" (K) 16.75"-20.75" (Y)	16.5"-20.125" (T) 17.5"-20.5" (K) 16.75"-20.75" (Y)	17.5"-21.5" (Y) (B7)
	16.88"-20.25" (Y) (B3/B8)	16.88"-20.25" (Y) (B3/B8)	16.88"-20.25" (Y) (B5)
Back Width	18.25"	18.3"	18.3"
Back Height	20"	23.5"	21.5"
Materials			
COM	1.15 yd	1.25 yd	1.25 yd
COL	23 sq ft	25 sq ft	31 sq ft
Weight and Capacity			
Weight Armless	35.5 lb	36.5 lb	47 lb
Weight With Arms	41.5 lb	42.5 lb	53 lb
Weight Capacity	300 lb	300 lb	400 lb
Warranty	350 lb (HD)	350 lb (HD)	

Swivel tilt mechanism (T). Knee tilt mechanism (K). Enhanced synchro mechanism (Y). High profile polished aluminum base (B3). High profile brushed aluminum base (B8). Heavy Duty (HD). Heavy Duty black nylon base (B7). Heavy Duty polished aluminum base (B5).



Good
Featured with SitOnIt Seating's
Dash - Tiffany

Focus

UPHOLSTERED BACK TASK STOOL

Where comfort, style and ergonomics converge.

Experience something so comfortable it hardly ever crosses your mind—from the moment you sit down until it's time to head home. Our bestselling seating solution works just about anywhere you need thanks to a wider back frame, extra-deep seat and almost endless options to customize.

Our signature dual-curve frame takes its cues from modern, industrial design while also reinforcing key points of contact, so your back is optimally supported throughout the day. Plus, a built-in lumbar system helps promote correct posture so that you spend more time working and less time (re)adjusting your seat.



Best
Featured with SitOnIt Seating's
Huntington – Tropical

EFFECTIVE NOVEMBER 4, 2024

Featured Models

GOOD :: \$1,004

Midback upholstered, task stool, basic mechanism, armless, black nylon base, grade 1 textile

BETTER :: \$1,084

Highback upholstered, task stool, basic mechanism, height-adjustable arms, black nylon base, grade 1 textile

BEST :: \$1,238

Highback upholstered, task stool, adjustable lumbar support, basic mechanism, fully multi-adjustable (10-way) sport arms, extended stool kit, black nylon base, grade 1 textile



FOCUS

EFFECTIVE NOVEMBER 4, 2024 | GSA SIN #: 33721

Features

- Ergonomic back support and comfort
- Midback and highback
- Relaxed-fit upholstered pad
- Adjustable lumbar option
- Nine ergonomic arm styles with standard or Sport arm pads
- Black or silver accents
- Waterfall seat
- Optional Sport casters
- Complements Focus 2.0 task chair and Focus Side chair, counter and bar stool; see [page 74](#) and [page 234](#)
- Standard 300 lb weight capacity warranty

1. Back

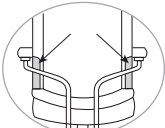
Back Size and Style	Code	Price	
Midback Relaxed-Fit Upholstered Pad	5622 B4	\$1,049	
Highback Relaxed-Fit Upholstered Pad	5623 B4	\$1,084	
Back Options	Code	Price	
Adjustable Lumbar Support	LB1	+ \$50	

UPHOLSTERED BACK TASK STOOL

2. Mechanism

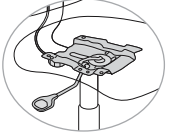
Mechanism	Code	Price	
Basic (Swivel Only)	B	+\$0	

3. Frame

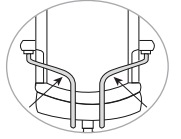
Back Support Color	Code	Price	
Black	Z1	+ \$0	
Silver	Z2	+ \$20	



Good
Featured with SitOnIt Seating's
Dash – Flame





4. Arms

Arm Style	Code	Price	
Armless	A0	- \$45	
Fixed Arms	A91	- \$10	
Height-Adjustable	A92	+ \$0	
Height-Adjustable With Sport Arm Pads	A152	+ \$0	
Height-/Width-Adjustable	A93	+ \$35	
Height-/Width-Adjustable With Sport Arm Pads	A153	+ \$35	
Fully Adjustable (6-Way)	A94	+ \$70	
Fully Adjustable (6-Way) With Sport Arm Pads	A154	+ \$70	
Fully Multi-Adjustable (10-Way)	A95	+ \$80	
Fully Multi-Adjustable (10-Way) With Sport Arm Pads	A155	+ \$80	

Fixed arms (A91) are not available with the enhanced synchro (Y) mechanism.

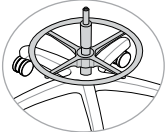
UPHOLSTERED BACK TASK STOOL

5. Base

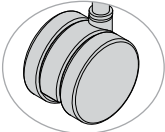
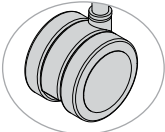
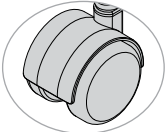
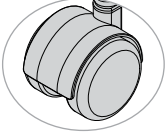
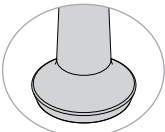
Base	Code	Price	
Stool Kit	S1	+ \$0	
Extended Stool Kit	S2	+ \$24	
Base Color and Material	Code	Price	
Black Nylon Base	B6	+ \$0	
Polished Aluminum Base	B5	+ \$169	
Casters or Glides	Code	Price	
Casters			
Carpet Casters	C5	+ \$0	
Carpet Casters (For Higher Cylinder Only)	C21	+ \$0	
Sport Carpet Casters	C31	+ \$0	
Sport Hard Floor and Carpet Casters	C32	+ \$45	
Hard Floor and Carpet Casters	C1	+ \$45	
Hard Floor and Carpet Casters (For Higher Cylinder Only)	C22	+ \$45	
Self-Locking Carpet Casters	C2	+ \$30	
Self-Locking Hard Floor and Carpet Casters	C7	+ \$61	
Glides			
Glides for Task Chairs	C3	+ \$35	

Self-locking casters (C2/C7) lock only when not in use.

6. Material

Protection	Code	Price
Fire Retardancy		
CAL 133, Fabric, Quantities 1–49	133F	+ \$99
CAL 133, Fabric, Quantities 50+	133F5	+ \$55
CAL 133, Leather, Any Quantity	133L	+ \$119
Seat and Back Textile	Code	Price
Fabric/Vinyl Grade 1	FG1/VG1	+ \$0
COM	COM	+ \$40
Fabric/Vinyl Grade 2	FG2/VG2	+ \$40
Fabric/Vinyl Grade 3	FG3/VG3	+ \$74
Fabric/Vinyl Grade 4	FG4/VG4	+ \$121
Fabric/Vinyl Grade 5	FG5/VG5	+ \$174
Fabric/Vinyl Grade 6	FG6/VG6	+ \$235
Fabric/Vinyl Grade 7	FG7/VG7	+ \$296
Leather Grade 1	LG1	+ \$320
COL	COL	+ \$420
Leather Grade 2	LG2	+ \$420
Leather Grade 3	LG3	+ \$540

Please reference the [Textile Reference Guide](#) for pricing on fabric over grade 7 and leather over grade 3. Additional CAL 133 information can be found on [page 15](#).

Please reference the [Fabric information](#) found on [page 17](#) for pricing on multi-upholstery.

7. Packaging

Packaging	Code	Price
Knocked Down	KD	+ \$0
Back Attached to Seat, Base Separate	UC	+ \$80
Fully Assembled in a Carton	AC	+ \$200

UPHOLSTERED BACK TASK STOOL

MIDBACK SPECIFICATIONS

	5622 B4 S1 Upholstered Task Stool	5622 B4 S2 Upholstered Extended Task Stool
Dimensions		
Overall Width Armless	27.3"	27.3"
Overall Width With Arms	27.3"	27.3"
Overall Depth	25"	25"
Overall Height	41.6"	46"
Seat Width	19"	19"
Seat Depth	18.5"	18.5"
Seat Height	21"–29"	24"–34"
Back Width	18.25"	18.25"
Back Height	20"	20"
Materials		
COM	1.15 yd	1.15 yd
COL	23 sq ft	23 sq ft
Weight and Capacity		
Weight Armless	39.5 lb	40.5 lb
Weight With Arms	45.5 lb	46.5 lb
Weight Capacity	300 lb	300 lb

HIGHBACK SPECIFICATIONS

	5623 B4 S1 Upholstered Task Stool	5623 B4 S2 Upholstered Extended Task Stool
Dimensions		
Overall Width Armless	20"	20"
Overall Width With Arms	27.5"	27.5"
Overall Depth	26"	26"
Overall Height	45"	50"
Seat Width	20"	20"
Seat Depth	18.5"	18.5"
Seat Height	21"–29"	24"–34"
Back Width	18.3"	18.3"
Back Height	23.5"	23.5"
Materials		
COM	1.15 yd	1.15 yd
COL	23 sq ft	23 sq ft
Weight and Capacity		
Weight Armless	40.5 lb	41.5 lb
Weight With Arms	46.5 lb	47.5 lb
Weight Capacity	300 lb	300 lb

Focus 2.0

MESH BACK TASK CHAIR

Focus reimagined.

Focus™ 2.0 is more than a makeover. It's a modernization. It's driving dependable design forward with innovative mesh, enhanced (and expanded) customization, advanced functionality and a slimmer silhouette that offers superior comfort from integrated lumbar support and cutting-edge ergonomics. Focus 2.0 is everything you loved in the first generation and more.



Best
Featured with Ocean mesh and
SitOnIt Seating's Dash – Dove

EFFECTIVE NOVEMBER 4, 2024

Featured Models

GOOD :: \$723

Midback mesh with adjustable lumbar support, swivel-tilt mechanism, height-adjustable arms, black frame, black nylon Y-support, black nylon base, accent color, carpet casters, grade 1 textile

BETTER :: \$843

Highback mesh back with adjustable lumbar support, enhanced synchro mechanism, height-/width-adjustable (4-way) arms, black frame, black nylon Y-support, black nylon base, accent color, carpet casters, grade 1 textile

BEST :: \$1,027

Highback mesh with adjustable lumbar support, enhanced synchro mechanism with seat-depth adjustment, fully adjustable (8-way) arms, white frame, piano black Y-support, white nylon base, accent color, carpet casters, grade 1 textile



FOCUS 2.0

EFFECTIVE NOVEMBER 4, 2024 | GSA SIN #: 33721

Features

- Slimmer, refined design
- Swivel-tilt and enhanced synchro mechanism
- Optional seat-depth adjustment
- Modernized Y-support customizable in four colors, including piano black
- Three frame and four base colors
- Armless, fixed, height-adjustable, height-/width-adjustable or fully adjustable arms
- 12 accent colors for pull handle stripe, lumbar casing, arm adjustment and caster rings
- Three exclusive mesh options in Focus mesh, Focus 2.0 mesh and Focus Uptown mesh
- Adjustable lumbar support included
- Performance casters color coordinate with frame and base
- Complements Focus task chair and stool and Focus Side chair, counter and bar stool; see [page 56](#) and [page 234](#)
- 300 lb weight capacity warranty

1. Back

Back Size and Style	Code	Price	
Midback Mesh With Adjustable Lumbar	1123 BK1 MB	\$773	
Highback Mesh With Adjustable Lumbar	1123 BK2 MB	\$808	

MESH BACK TASK CHAIR

2. Mechanism

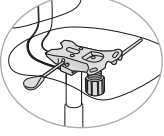
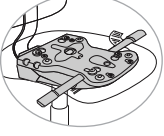
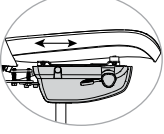
Mechanism Style	Code	Price	
Swivel-Tilt	T	- \$50	
Enhanced Synchro	Y	+ \$0	
Enhanced Synchro With Seat-Depth Adjustment	Y/E3	+ \$79	

3. Frame

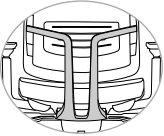
Frame Color	Code	Price	
Black	FC1	+ \$0	
Fog	FC13	+ \$45	
White	FC12	+ \$45	
Y-Support Color	Code	Price	
Black	YCC01	+ \$0	
White	YCC02	+ \$0	
Fog	YCC03	+ \$0	
Piano Black	YCC04	+ \$25	

FOCUS 2.0

EFFECTIVE NOVEMBER 4, 2024 | GSA SIN #: 33721

3. Frame (Cont.)

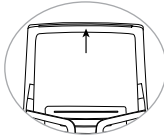
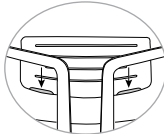
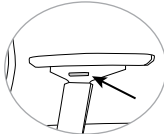
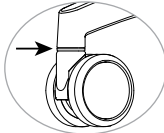
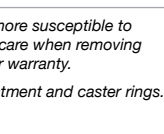

Accent Color	Code	Price	
Apple	LA12	+ \$0	
Desert	LA3	+ \$0	
Electric Blue	LA5	+ \$0	
Fire	LA6	+ \$0	
Fog	LA4	+ \$0	
Graphite	LA14	+ \$0	
Navy	LA15	+ \$0	
Nickel	LA2	+ \$0	
Ocean	LA10	+ \$0	
Onyx	LA1	+ \$0	
Tangerine	LA9	+ \$0	
White	LA13	+ \$0	

Due to the high-gloss material, the piano black Y-support (YCC04) is more susceptible to scratches and scuffs in a workstation environment and requires more care when removing protective packaging. Scratches and scuffs may not be covered under warranty.

Accent color is applied to pull handle stripe, lumbar casing, arm adjustment and caster rings.

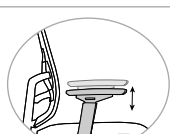
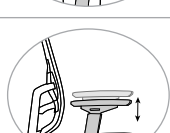
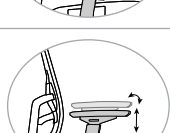

MESH BACK TASK CHAIR

4. Arms

Arm Style	Code	Price	
Armless	AR0	- \$45	
Fixed Arms	AR2	- \$10	
Height-Adjustable	AR4	+ \$0	
Height-/Width-Adjustable (4-Way)	AR6	+ \$35	
Fully Adjustable (8-Way)	AR9	+ \$70	

Arms, if specified, come with fog arm pads for the white (FC12) and fog (FC13) frames and black arm pads for the black frame (FC1).

5. Base

Base Style	Code	Price	
5-Star Nylon	BT1	+ \$0	
5-Star Polished Aluminum	BT2	+ \$119	

Nylon Base Color	Code	Price	
Black Nylon Base	BC1	+ \$0	
Fog Nylon Base	BC4	+ \$0	
White Nylon Base	BC3	+ \$0	

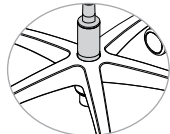
Cylinder Height	Code	Price	
Higher Cylinder	CH3	+ \$0	
Standard Cylinder	CH1	+ \$0	

FOCUS 2.0

EFFECTIVE NOVEMBER 4, 2024 | GSA SIN #: 33721

5. Base (Cont.)

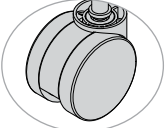
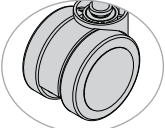
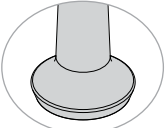
Casters or Glides	Code	Price	
Casters			
Carpet Casters	CS5	+ \$0	
Hard Floor and Carpet Casters	CS6	+ \$45	
Glides			
Glides for Task Chairs	CS3	+ \$35	

6. Material

Mesh	Code	Price	
Focus 2.0 Mesh			
Apple	MC31	+ \$0	
Desert	MC9	+ \$0	
Electric Blue	MC13	+ \$0	
Fire	MC10	+ \$0	
Fog	MC7	+ \$0	
Navy	MC8	+ \$0	
Nickel	MC6	+ \$0	
Ocean	MC29	+ \$0	
Onyx	MC5	+ \$0	
Tangerine	MC28	+ \$0	
Focus 2.0 Uptown Mesh			
Midnight	MC43	+ \$0	
Charcoal	MC44	+ \$0	
Ash	MC45	+ \$0	
Dune	MC46	+ \$0	
Focus Mesh			
Black	MC1	+ \$0	
Sand	MC3	+ \$0	
Slate	MC2	+ \$0	
Freeway Sport Stripe (Black/Slate)	MC33	+ \$0	
Impress Sport Stripe (Slate/Black)	MC34	+ \$0	

Sport striped meshes list the predominant color first.

MESH BACK TASK CHAIR

6. Material (Cont.)

Seat Textile	Code	Price	
Fabric/Vinyl Grade 1	FG1/VG1	+ \$0	
COM	COM	+ \$30	
Fabric/Vinyl Grade 2	FG2/VG2	+ \$30	
Fabric/Vinyl Grade 3	FG3/VG3	+ \$60	
Fabric/Vinyl Grade 4	FG4/VG4	+ \$116	
Fabric/Vinyl Grade 5	FG5/VG5	+ \$172	
Fabric/Vinyl Grade 6	FG6/VG6	+ \$213	
Fabric/Vinyl Grade 7	FG7/VG7	+ \$254	
Leather Grade 1	LG1	+ \$300	
COL	COL	+ \$380	
Leather Grade 2	LG2	+ \$380	
Leather Grade 3	LG3	+ \$480	

Please reference the [Textile Reference Guide](#) for pricing on fabric over grade 7 and leather over grade 3.



Better
Featured with Midnight mesh and
SitOnIt Seating's Spice - Fire

FOCUS 2.0

MESH BACK TASK CHAIR

EFFECTIVE NOVEMBER 4, 2024 | GSA SIN #: 33721

7. Packaging

Mesh	Code	Price
Knocked Down	KD	+ \$0
Back Attached to Seat, Base Separate	UC	+ \$80
Fully Assembled in a Carton	AC	+ \$200

SPECIFICATIONS

	1123 BK1 MB Midback Mesh Task Chair	1123 BK2 MB Highback Mesh Task Chair
Dimensions		
Overall Width Without Arms	26"	26"
Overall Width With Arms	28.5"	28.5"
Overall Depth	28"	26"
Overall Height	33.25"-36.75"	36.25"-39.75"
Seat Width	19.5"	19.5"
Seat Depth	17.7"-19.6" 16.75"-19.25" (Y/E3)	17.7"-19.6" 16.75"-19.25" (Y/E3)
Seat Height	16.6"-20.1" (T) 16.9"-20.4" (Y)	16.6"-20.1" (T) 16.9"-20.4" (Y)
Seat Height With Higher Cylinder	17.1"-22.3" (T) 17.4"-22.6" (Y)	17.1"-22.3" (T) 17.4"-22.6" (Y)
Back Width	18.5"	18.5"
Back Height	19.5"	22.5"
Materials		
COM	1 yd	1 yd
COL	14 sq ft	14 sq ft
Weight and Capacity		
Weight Armless	31 lb	32 lb
Weight With Arms	37 lb	38 lb
Weight Capacity Warranty	300 lb	300 lb

Swivel-tilt mechanism (T), Enhanced synchro mechanism (Y), Enhanced synchro with seat-depth adjustment (Y/E3)



Good
Featured with Fog mesh and
SitOnIt Seating's Malibu - Smoke

Focus 2.0

MESH BACK TASK STOOL

Focus reimagined.

Focus™ 2.0 is more than a makeover. It's a modernization. It's driving dependable design forward with innovative mesh, enhanced (and expanded) customization, advanced functionality and a slimmer silhouette that offers superior comfort from integrated lumbar support and cutting-edge ergonomics. Focus 2.0 is everything you loved in the first generation and more.



*Midback With Height-Adjustable Arms
Featured with Onyx mesh and
SitOnIt Seating's Venice – Sundown*

EFFECTIVE NOVEMBER 4, 2024

Featured Models

GOOD :: \$818

Midback mesh with adjustable lumbar support, basic mechanism, black frame, black Y-support, armless, standard stool kit, nylon base, carpet casters, grade 1 textile

BETTER :: \$908

Midback mesh with adjustable lumbar support, basic mechanism, white frame, white Y-support, height-adjustable arms, standard stool kit, nylon base, carpet casters, grade 1 textile

BEST :: \$1,077

Midback mesh with adjustable lumbar support, basic mechanism, fully adjustable (8-way) arms, black frame, piano black Y-support, polished aluminum base, carpet casters, grade 1 textile

FOCUS 2.0

EFFECTIVE NOVEMBER 4, 2024 | GSA SIN #: 33721

Features

- Slimmer, refined design
- Basic mechanism
- Modernized Y-support customizable in four colors, including piano black
- Three frame and four base colors
- Armless, fixed, height-adjustable, height-/width-adjustable or fully adjustable arms
- 12 accent colors for pull handle stripe, lumbar casing, arm adjustment and caster rings
- Three exclusive mesh options in Focus mesh, Focus 2.0 mesh and Focus Uptown mesh
- Adjustable lumbar support included
- Performance casters color coordinate with frame and base
- Complements Focus task chair and stool and Focus Side chair, counter and bar stool; see [page 56](#) and [page 234](#)
- 300 lb weight capacity warranty

1. Back

Back Size and Style	Code	Price	
Midback Mesh With Adjustable Lumbar	1123 BK1 MB	\$863	

2. Mechanism



Mechanism Style	Code	Price	
Basic (Swivel Only)	B	+ \$0	

MESH BACK TASK STOOL

3. Frame

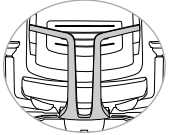
Frame Color	Code	Price	
Black	FC1	+ \$0	
Fog	FC13	+ \$45	
White	FC12	+ \$45	

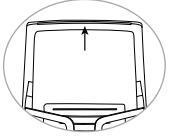
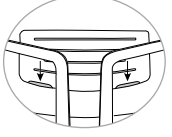
Y-Support Color	Code	Price	
Black	YCC01	+ \$0	
White	YCC02	+ \$0	
Fog	YCC03	+ \$0	
Piano Black	YCC04	+ \$25	

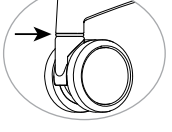
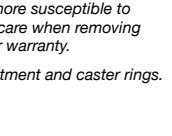
Accent Color	Code	Price	
Apple	LA12	+ \$0	
Desert	LA3	+ \$0	
Electric Blue	LA5	+ \$0	
Fire	LA6	+ \$0	
Fog	LA4	+ \$0	
Graphite	LA14	+ \$0	
Navy	LA15	+ \$0	
Nickel	LA2	+ \$0	
Ocean	LA10	+ \$0	
Onyx	LA1	+ \$0	
Tangerine	LA9	+ \$0	
White	LA13	+ \$0	





Due to the high-gloss material, the piano black Y-support (YCC04) is more susceptible to scratches and scuffs in a workstation environment and requires more care when removing protective packaging. Scratches and scuffs may not be covered under warranty.

Accent color is applied to pull handle stripe, lumbar casing, arm adjustment and caster rings.

FOCUS 2.0

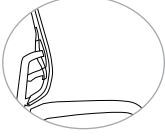

EFFECTIVE NOVEMBER 4, 2024 | GSA SIN #: 33721

4. Arms

Arm Style	Code	Price	
Armless	AR0	- \$45	
Fixed Arms	AR2	- \$10	
Height-Adjustable	AR4	+ \$0	
Height-/Width-Adjustable (4-Way)	AR6	+ \$35	
Fully Adjustable (8-Way)	AR9	+ \$70	

Arms, if specified, come with fog arm pads for the white (FC12) and fog (FC13) frames and black arm pads for the black frame (FC1).

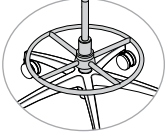
5. Base

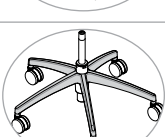
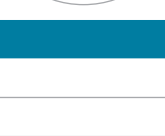
Base	Code	Price	
Stool Kit	S1	+ \$0	
Extended Stool Kit	S2	+ \$24	
Base Style	Code	Price	
5-Star Nylon	BT1	+ \$0	
5-Star Polished Aluminum	BT2	+ \$119	
Nylon Base Color	Code	Price	
Black Nylon Base	BC1	+ \$0	
Fog Nylon Base	BC4	+ \$0	
White Nylon Base	BC3	+ \$0	

MESH BACK TASK STOOL

5. Base (Cont.)

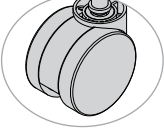
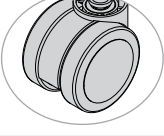
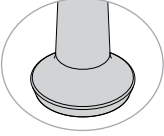
Casters or Glides	Code	Price	
Casters			
Carpet Casters	CS5	+ \$0	
Hard Floor and Carpet Casters	CS6	+ \$45	
Glides			
Glides for Task Chairs	CS3	+ \$35	

6. Material

Mesh	Code	Price	
Focus 2.0 Mesh			
Apple	MC31	+ \$0	
Desert	MC9	+ \$0	
Electric Blue	MC13	+ \$0	
Fire	MC10	+ \$0	
Fog	MC7	+ \$0	
Navy	MC8	+ \$0	
Nickel	MC6	+ \$0	
Ocean	MC29	+ \$0	
Onyx	MC5	+ \$0	
Tangerine	MC28	+ \$0	
Focus 2.0 Uptown Mesh			
Midnight	MC43	+ \$0	
Charcoal	MC44	+ \$0	
Ash	MC45	+ \$0	
Dune	MC46	+ \$0	
Focus Mesh			
Black	MC1	+ \$0	
Sand	MC3	+ \$0	
Slate	MC2	+ \$0	
Freeway Sport Stripe (Black/Slate)	MC33	+ \$0	
Impress Sport Stripe (Slate/Black)	MC34	+ \$0	

Sport striped meshes list the predominant color first.

6. Material (Cont.)

Seat Textile	Code	Price
Fabric/Vinyl Grade 1	FG1/VG1	+ \$0
COM	COM	+ \$30
Fabric/Vinyl Grade 2	FG2/VG2	+ \$30
Fabric/Vinyl Grade 3	FG3/VG3	+ \$60
Fabric/Vinyl Grade 4	FG4/VG4	+ \$116
Fabric/Vinyl Grade 5	FG5/VG5	+ \$172
Fabric/Vinyl Grade 6	FG6/VG6	+ \$213
Fabric/Vinyl Grade 7	FG7/VG7	+ \$254
Leather Grade 1	LG1	+ \$300
COL	COL	+ \$380
Leather Grade 2	LG2	+ \$380
Leather Grade 3	LG3	+ \$480

Please reference the [Textile Reference Guide](#) for pricing on fabric over grade 7 and leather over grade 3.

7. Packaging

Mesh	Code	Price
Knocked Down	KD	+ \$0
Back Attached to Seat, Base Separate	UC	+ \$80
Fully Assembled in a Carton	AC	+ \$200

MESH BACK TASK STOOL

SPECIFICATIONS

	1123 BK1 MB S1 Task Stool	1123 BK1 MB S2 Extended Task Stool
Dimensions		
Overall Width Without Arms	26"	26"
Overall Width With Arms	28.5"	28.5"
Overall Depth	28"	28"
Overall Height	39"-46.5"	42.13"-52"
Seat Width	19.5"	19.5"
Seat Depth	18"	18"
Seat Height	20.5"-28"	23.37"-33.25"
Back Width	18.5"	18.5"
Back Height	19.5"	19.5"
Materials		
COM	1 yd	1 yd
COL	14 sq ft	14 sq ft
Weight and Capacity		
Weight Armless	32.2 lb	33.2 lb
Weight With Arms	37 lb	38 lb
Weight Capacity Warranty	300 lb	300 lb

Swivel-tilt mechanism (T). Enhanced synchro mechanism (Y).

Glove Active

CONFERENCE CHAIR

The lap of luxury.

The Glove™ Active is a luxurious leadership chair that combines pillow-top padding with classic tufted leather seating. It boasts an abundance of foam padding and folds of leather. Available with four mechanism choices, six adjustable arm styles, and optional seat-depth adjustment, Glove Active raises the bar for flexibility and control. It's a luxurious choice for guest and task seating in an executive suite, boardroom or behind a manager's desk.



Better

*Featured with Green Hide's
Sierra leather – Camel.*

EFFECTIVE NOVEMBER 4, 2024

Featured Models

GOOD :: \$1,755

Midback, swivel-tilt mechanism, loop arms, nylon base, grade 1 leather

BETTER :: \$2,150

Highback, enhanced synchro mechanism, height-adjustable arms, nylon base, grade 2 leather

BEST :: \$2,429

Highback, multi-function mechanism with seat-depth adjustment, height-/width-adjustable arms with pivot, brushed aluminum base, grade 2 leather

Features

- Pillow top
- Midback or highback
- Waterfall seat
- 250 lb weight capacity warranty;
350 lb Heavy Duty weight capacity warranty

1. Back

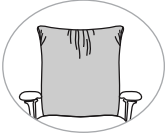
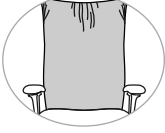
Back Size and Style	Code	Price	
Midback	7531	\$1,575	
Highback	7532	\$1,610	



2. Super Duty

Super Duty Series	Code	Price	
Heavy Duty	HD	+ \$200	

Heavy duty option not available with swivel-tilt (T) mechanism. See the Super Duty Guide on [page 626](#) for additional LT and HD options.

CONFERENCE CHAIR

3. Mechanism

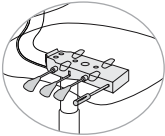
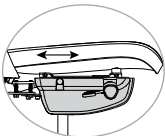
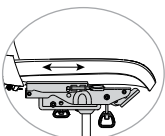
Mechanism Style	Code	Price	
Swivel-Tilt	T	- \$50	
Enhanced Synchro	Y	+ \$0	
Multi-Function	M	+ \$36	
Enhanced Synchro With Seat-Depth Adjustment	Y E3	+ \$79	
Multi-Function With Seat-Depth Adjustment	M E3	+ \$115	





Good
Featured with SitOnIt Seating's
Rally leather – Black.

4. Arms

Arm Style	Code	Price	
Armless	A0	- \$80	
Fixed Loop	A26	- \$10	
Height-Adjustable	A27-L	+ \$0	
Height-Adjustable With Pivot	A27	+ \$10	
Height-/Width-Adjustable	A28-L	+ \$35	
Height-/Width-Adjustable With Pivot	A28	+ \$45	

Heavy Duty (HD) option not available with fixed loop arms.

5. Base

Base Color and Material	Code	Price	
Black Nylon Base	B0	+ \$0	
Heavy Duty Black Nylon Base, 26" (For HD)	B7	+ \$0	
Brushed Aluminum Base	B2	+ \$119	

Aluminum base (B2) not available with seat-depth adjustment (E3).

CONFERENCE CHAIR

5. Base (Cont.)

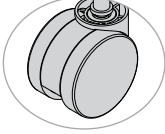
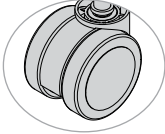
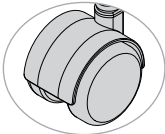
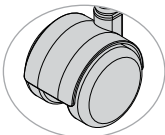
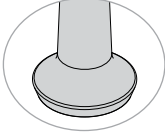
Casters or Glides	Code	Price	
Casters			
Black Carpet Casters	C11	+ \$0	
Black Hard Floor and Carpet Casters	C9	+ \$45	
Self-Locking Carpet Casters	C2	+ \$30	
Self-Locking Hard Floor and Carpet Casters	C7	+ \$61	
Glides			
Glides for Task Chairs	C3	+ \$35	

Self-locking casters (C2/C7) lock only when not in use. Self-locking casters not available for Heavy Duty series.

6. Material

Ballistic Nylon	Code	Price
Ballistic Nylon Back	BN	+ \$0
None	N	+ \$0
Seat and Back Textile	Code	Price
Fabric/Vinyl Grade 1	FG1/VG1	+ \$0
COM	COM	+ \$45
Fabric/Vinyl Grade 2	FG2/VG2	+ \$45
Fabric/Vinyl Grade 3	FG3/VG3	+ \$84
Fabric/Vinyl Grade 4	FG4/VG4	+ \$156
Fabric/Vinyl Grade 5	FG5/VG5	+ \$228
Fabric/Vinyl Grade 6	FG6/VG6	+ \$304
Fabric/Vinyl Grade 7	FG7/VG7	+ \$378
Leather Grade 1	LG1	+ \$240
COL	COL	+ \$540
Leather Grade 2	LG2	+ \$540
Leather Grade 3	LG3	+ \$820
Leather/Ballistic Grade 2	BN2	+ \$379
Leather/Ballistic Grade 3	BN3	+ \$631

Please reference the [Textile Reference Guide](#) for pricing on fabric over grade 7 and leather over grade 3.

Please reference the Fabric information found on [page 17](#) for pricing on multi-upholstery.

Note: Due to the alignment between chair panels, the chairs ordered in a textile will ship with a black spacer mesh outer back. Chairs ordered in vinyl or leather ship fully upholstered in the finish selected.

7. Packaging

Packaging	Code	Price
Back Attached to Seat, Base Separate	UC	+ \$0
Fully Assembled in a Carton	AC	+ \$120

CONFERENCE CHAIR

SPECIFICATIONS

	7531 Midback Chair	7532 Highback Chair
Dimensions		
Overall Width	27.75"	27.75"
Overall Depth	25"	25"
Overall Height	40" (T) 40.5 (Y/M)	43" (T) 43.5 (Y/M)
With Aluminum Base	40.5" (T/B2) 41" (Y/M/B2)	43.5" (T/B2) 44" (Y/M/B2)
Seat Width	19.75"	19.75"
Seat Depth	17"	18"
Seat Height	16.25"-20.75" (T) 16.5"-20" (Y) 16.5"-21" (M)	16.25"-20.75" (T) 16.5"-20" (Y) 16.5"-21" (M)
With Aluminum Base	16.75"-21.25" (T) (B2) 17"-20.5" (Y) (B2) 17"-21.5" (M) (B2)	16.75"-21.25" (T) (B2) 17"-20.5" (Y) (B2) 17"-21.5" (M) (B2)
Back Width	23"	23"
Back Height	19.5"	22.5"
Materials		
COM	2.4 yd 1.25 yd (BN)	2.5 yd 1.4 yd (BN)
COL	50 sq ft 36 sq ft (BN)	55 sq ft 42 sq ft (BN)
Weight and Capacity		
Weight	56 lb (T) 63 lb (Y) 64 lb (M)	59 lb (T) 66 lb (Y) 67 lb (M)
Weight	250 lb	250 lb
Capacity Warranty	350 lb (HD)	350 lb (HD)

Swivel-tilt mechanism (T). Enhanced synchro mechanism (Y). Heavy duty (HD).

Multi-function mechanism (M). Ballistic nylon back (BN). Brushed aluminum base (B2)

Glove Executive

CONFERENCE CHAIR

The lap of luxury.

The Glove™ Executive is a luxurious leadership chair that combines pillow-top padding with classic tufted leather seating. Boasting an abundance of foam padding and folds of leather, Glove is the seat of comfort for the head of a boardroom conference table or the corner office.



Better
Featured with SitOnIt Seating's
Rally leather – Black.

EFFECTIVE NOVEMBER 4, 2024

Featured Models

GOOD :: \$1,866

Midback, swivel-tilt mechanism, loop arms, nylon base, grade 1 leather

BETTER :: \$2,018

Midback, knee-tilt mechanism, loop arms, brushed aluminum base, grade 1 leather

BEST :: \$2,353

Highback, knee-tilt mechanism, loop arms, brushed aluminum base, grade 2 leather

GLOVE EXECUTIVE

EFFECTIVE NOVEMBER 4, 2024 | GSA SIN #: 33721

Features

- Pillow top
- Midback or highback
- Optional button detail
- Waterfall seat
- 250 lb weight capacity warranty;
350 lb Heavy Duty weight capacity warranty

1. Back

Back Size and Style	Code	Price	
---------------------	------	-------	--

Midback

7541

\$1,659



Highback

7542

\$1,694

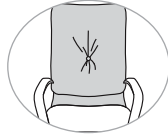

Back Options	Code	Price	
--------------	------	-------	--

Remove Button

RB

+ \$0

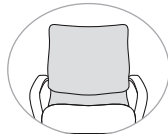

2. Mechanism

Mechanism Style	Code	Price	
-----------------	------	-------	--

Swivel-Tilt

T

- \$33



Knee-Tilt

K

+ \$0



CONFERENCE CHAIR

3. Arms

Arm Style	Code	Price	
-----------	------	-------	--

Fixed Loop

A26

+ \$0



4. Base

Base Color and Material	Code	Price	
-------------------------	------	-------	--

Black Nylon Base

B0

+ \$0



Brushed Aluminum Base

B2

+ \$119



Casters or Glides	Code	Price	
-------------------	------	-------	--

Casters

Carpet Casters

C5

+ \$0

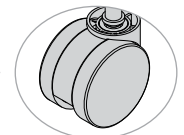

Black Carpet Casters
(For Brushed Aluminum Base B2)

C11

+ \$0

Hard Floor and
Carpet Casters

C1

+ \$45

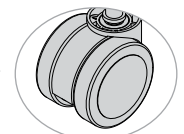

Black Hard Floor
and Carpet Casters
(For Brushed Aluminum Base B2)

C9

+ \$61

Self-Locking Carpet Casters

C2

+ \$30

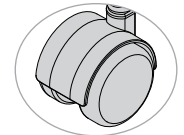

Self-Locking Hard Floor and
Carpet Casters

C7

+ \$61

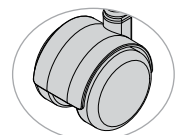

Glides

Glides for Task Chairs

C3

+ \$35

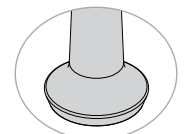

Self-locking casters (C2/C7) lock only when not in use.

GLOVE EXECUTIVE

EFFECTIVE NOVEMBER 4, 2024 | GSA SIN #: 33721

5. Material

Ballistic Nylon Back	Code	Price
Ballistic Nylon Back	BN	+ \$0
None	N	+ \$0
Seat and Back Textile	Code	Price
Fabric/Vinyl Grade 1	FG1/VG1	+ \$0
COM	COM	+ \$45
Fabric/Vinyl Grade 2	FG2/VG2	+ \$45
Fabric/Vinyl Grade 3	FG3/VG3	+ \$84
Fabric/Vinyl Grade 4	FG4/VG4	+ \$156
Fabric/Vinyl Grade 5	FG5/VG5	+ \$228
Fabric/Vinyl Grade 6	FG6/VG6	+ \$304
Fabric/Vinyl Grade 7	FG7/VG7	+ \$378
Leather Grade 1	LG1	+ \$240
COL	COL	+ \$540
Leather Grade 2	LG2	+ \$540
Leather Grade 3	LG3	+ \$820
Leather/Ballistic Grade 2	BN2	+ \$379
Leather/Ballistic Grade 3	BN3	+ \$631

Please reference the [Textile Reference Guide](#) for pricing on fabric over grade 7 and leather over grade 3.

Please reference the [Fabric information](#) found on [page 17](#) for pricing on multi-upholstery.

Note: Due to the alignment between chair panels, the chairs ordered in a textile will ship with a black spacer mesh outer back. Chairs ordered in vinyl or leather ship fully upholstered in the finish selected.



Good
Featured with SitOnIt Seating's
Rally leather -Saddle.

CONFERENCE CHAIR

6. Packaging

Packaging	Code	Price
Back Attached to Seat, Base Separate	UC	+ \$0

SPECIFICATIONS

	7541 Midback Conference	7542 Highback Conference
Dimensions		
Overall Width	24.5"	24.5"
Overall Depth	27"	27"
Overall Height	42" (B0) 42.5" (B2)	48" (B0) 48.5" (B2)
Seat Width	20.5"	20.5"
Seat Depth	20"	20"
Seat Height With Aluminum Base	16.5"-21" (B0) 17"-21.5" (B2)	16.5"-21" (B0) 17"-21.5" (B2)
Back Width	22.75"	22.75"
Back Height	21"	27"
Materials		
COM	3.25 yd 2.15 yd (BN)	3.5 yd 2.35 yd (BN)
COL	56 sq ft 44 sq ft (BN)	70 sq ft 57 sq ft (BN)
Weight and Capacity		
Weight	61 lb (T) 64 lb (K)	69 lb (T) 72 lb (K)
Weight Capacity	250 lb	250 lb

Swivel-tilt mechanism (T). Knee-tilt mechanism (K). Ballistic nylon back (BN). Black nylon base (B0). Brushed aluminum base (B2)

Hexy

TASK AND CONFERENCE CHAIR

Powered by fusion.

Hexy is what happens when you let inspiration drive innovation—and engineer ergonomics right into the frame. Its hexagon core creates natural support so there's no need for external lumbar controls, and the high-performing mesh fuses with the extra-wide backrest seamlessly. It's the ultimate seat for action-packed (and comfort-backed) environments.



Better
Featured with tangerine mesh
and SitOnIt Seating's Dash – Fossil

EFFECTIVE NOVEMBER 4, 2024

Featured Models

GOOD :: \$557

Midback task chair, black frame, swivel-tilt mechanism, fixed arms, standard cylinder, carpet casters, grade 1 textile

BETTER :: \$617

Highback task chair, black frame, standard synchro mechanism, height-adjustable arms, standard cylinder, carpet casters, grade 1 textile



BEST :: \$776

Highback task chair, white frame, standard synchro mechanism with seat-depth adjustment, height-/width-adjustable (4-way) arms, standard cylinder, carpet casters, grade 1 textile

Features

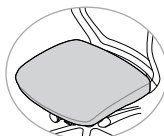

- Extra-wide backrest with innovative hexagon core provides integrated ergonomics
- Ultra-supportive performance mesh seamlessly fuses with a lightweight frame
- Aerodynamic arms and pull handle offer active comfort and convenience
- Multiple mesh, frame, arm and mechanism options let you customize endlessly

1. Back and Seat

Back Size and Style	Code	Price	
Midback Mesh	1203 BK1 MB	\$582	
Highback Mesh	1203 BK2 MB	\$617	
Seat	Code	Price	
Upholstered Seat	US	+ \$0	

TASK AND CONFERENCE CHAIR

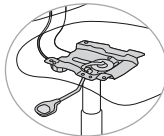

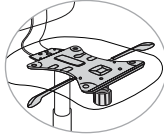
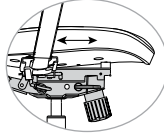
2. Mechanism

Mechanism Style	Code	Price	
Basic	B	- \$30	
Swivel-Tilt	T	- \$15	
Standard Synchro	F	+ \$0	
Standard Synchro With Seat-Depth Adjustment	F/E3	+ \$79	

3. Frame

Frame Color	Code	Price	
Black	FC1	+ \$0	
Fog	FC13	+ \$45	
White	FC12	+ \$45	

4. Arms

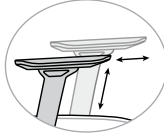
Arm Style	Code	Price	
Armless	AR0	- \$45	
Fixed Arm	AR2	- \$10	
Height-Adjustable	AR4	+ \$0	
Height/Width Adjustable (4-Way)	AR6	+ \$35	

5. Base

Base Style	Code	Price	
5-Star Nylon	BT1	+ \$0	

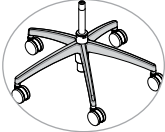
5-Star Polished Aluminum	BT2	+ \$119	
--------------------------	-----	---------	---

Base Color	Code	Price	
Black Nylon Base	BC1	+ \$0	
Fog Nylon Base	BC4	+ \$0	
White Nylon Base	BC3	+ \$0	

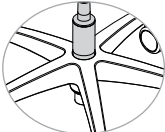
Cylinder Height	Code	Price	
Standard Cylinder	CH1	+ \$0	
Higher Cylinder	CH3	+ \$0	

Casters or Glides	Code	Price	
Casters			

Carpet Casters	CS5	+ \$0	
----------------	-----	-------	---

Hard Floor and Carpet Casters	CS6	+ \$45	
-------------------------------	-----	--------	---

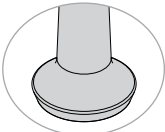
Glides			
Glides for Task Chairs	CS3	+ \$35	

The higher cylinder (CH3) is only available with the black base regardless of frame color.

TASK AND CONFERENCE CHAIR

6. Material

Mesh Color	Code	Price	
Apple	MC31	+ \$0	
Desert	MC22	+ \$0	
Electric Blue	MC24	+ \$0	
Fire	MC25	+ \$0	
Fog	MC23	+ \$0	
Navy	MC8	+ \$0	
Nickel	MC21	+ \$0	
Ocean	MC29	+ \$0	
Onyx	MC20	+ \$0	
Tangerine	MC28	+ \$0	

Seat Textile	Code	Price	
Fabric/Vinyl Grade 1	FG1/VG1	+ \$0	
COM	COM	+ \$30	
Fabric/Vinyl Grade 2	FG2/VG2	+ \$30	
Fabric/Vinyl Grade 3	FG3/VG3	+ \$60	
Fabric/Vinyl Grade 4	FG4/VG4	+ \$116	
Fabric/Vinyl Grade 5	FG5/VG5	+ \$172	
Fabric/Vinyl Grade 6	FG6/VG6	+ \$213	
Fabric/Vinyl Grade 7	FG7/VG7	+ \$254	
Leather Grade 1	LG1	+ \$300	
COL	COL	+ \$380	
Leather Grade 2	LG2	+ \$380	
Leather Grade 3	LG3	+ \$480	

Please reference the [Textile Reference Guide](#) for pricing on fabric over grade 7 and leather over grade 3.

7. Packaging

Packaging	Code	Price	
Knocked Down	KD	+ \$0	
Back Attached to Seat, Base Separate	UC	+ \$80	
Fully Assembled in a Carton	AC	+ \$200	

EFFECTIVE NOVEMBER 4, 2024 | GSA SIN #: 33721

SPECIFICATIONS

	1203 BK1 MB Midback Mesh	1203 BK2 MB Highback Mesh
Dimensions		
Overall Width Without Arms	26.25"	26.25"
Overall Width With Arms	26.25"	26.25"
Overall Depth	27"	27"
Overall Height	36.5"	39.5"
Seat Width	20"	20"
Seat Depth	17"-19"	17"-19"
Seat Height	16"-19.75" (B, CH1)	16"-19.75" (B, CH1)
	16.25"-20" (T, CH1)	16.25"-20" (T, CH1)
	16.75"-20.25" (F, CH1)	16.75"-20.25" (F, CH1)
	17"-20.625" (F/E3, CH1)	17"-20.625" (F/E3, CH1)
	16.25"-21.25" (B, CH3)	16.25"-21.25" (B, CH3)
	16.5"-21.5" (T, CH3)	16.5"-21.5" (T, CH3)
	17"-22" (F, CH3)	17"-22" (F, CH3)
Back Width	19.25"	19.5"
	19.25"	22.25"
Materials		
COM	1 yd	1 yd
COL	17 sq ft	17 sq ft
Weight and Capacity		
Weight Armless	32 lb	33 lb
Weight With Arms	38 lb	39 lb
Weight Capacity	300 lb	300 lb

Basic mechanism (B). Swivel-tilt mechanism (T). Standard synchro mechanism (F). Standard synchro mechanism with seat-depth adjustment (F/E3). Standard cylinder (CH1). Higher cylinder (CH3).



Best
Featured with ocean mesh and Momentum's Canter EPU - Ink

Hexy

MESH BACK TASK STOOL

Powered by fusion.

Hexy is what happens when you let inspiration drive innovation—and engineer ergonomics right into the frame. Its hexagon core creates natural support so there's no need for external lumbar controls, and the high-performing mesh fuses with the extra-wide backrest seamlessly. It's the ultimate seat for action-packed (and comfort-backed) environments.



EFFECTIVE NOVEMBER 4, 2024

Featured Models

GOOD :: \$644

Midback task stool, basic mechanism, black frame, armless, standard stool kit, nylon base, carpet casters, grade 1 textile

BETTER :: \$734

Midback task stool, basic mechanism, fog frame, height-adjustable arms, standard stool kit, nylon base, carpet casters, grade 1 textile,

BEST :: \$912

Midback task stool, basic mechanism, white frame, height-/width-adjustable (4-way) arms, extended stool kit, polished aluminum base, carpet casters, grade 1 textile,

Features

- Extra-wide backrest with innovative hexagon core provides integrated ergonomics
- Ultra-supportive performance mesh seamlessly fuses with a lightweight frame
- Aerodynamic arms and pull handle offer active comfort and convenience
- Multiple mesh, frame arm and mechanism options let you customize endlessly

1. Back and Seat

Back Size and Style	Code	Price	
Midback Mesh	1203 BK1 MB	\$689	

Seat	Code	Price	
Upholstered Seat	US	+\$0	

2. Mechanism



Mechanism Style	Code	Price	
Basic	B	+\$0	

3. Frame

Frame Color	Code	Price	
Black	FC1	+\$0	
Fog	FC13	+\$45	
White	FC12	+\$45	

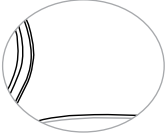

TASK STOOL

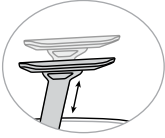
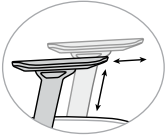
4. Arms

Arm Style	Code	Price	
Armless	AR0	-\$45	
Fixed Arm	AR2	-\$10	
Height-Adjustable	AR4	+\$0	
Height/Width Adjustable (4-Way)	AR6	+\$35	

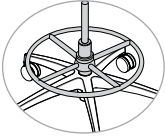
5. Base

Base	Code	Price	
Stool Kit	S1	+\$0	
Extended Stool Kit	S2	+\$24	

Base Style	Code	Price	
5-Star Nylon	BT1	+\$0	
5-Star Polished Aluminum	BT2	+\$119	

Base Color	Code	Price	
Black Nylon Base	BC1	+\$0	
Fog Nylon Base	BC4	+\$0	
White Nylon Base	BC3	+\$0	

5. Base (Cont.)

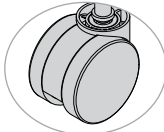
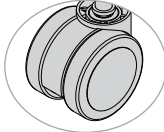
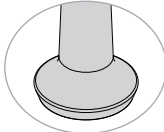
Casters or Glides	Code	Price	
Casters			
Carpet Casters	CS5	+ \$0	
Hard Floor and Carpet Casters	CS6	+ \$45	
Glides			
Glides for Task Chairs	CS3	+ \$35	

The higher cylinder (CH3) is only available with the black base regardless of frame color.

6. Material

Mesh Color	Code	Price
Apple	MC31	+ \$0
Desert	MC22	+ \$0
Electric Blue	MC24	+ \$0
Fire	MC25	+ \$0
Fog	MC23	+ \$0
Navy	MC8	+ \$0
Nickel	MC21	+ \$0
Ocean	MC29	+ \$0
Onyx	MC20	+ \$0
Tangerine	MC28	+ \$0

TASK STOOL

6. Material (Cont.)

Seat Textile	Code	Price
Fabric/Vinyl Grade 1	FG1/VG1	+ \$0
COM	COM	+ \$30
Fabric/Vinyl Grade 2	FG2/VG2	+ \$30
Fabric/Vinyl Grade 3	FG3/VG3	+ \$60
Fabric/Vinyl Grade 4	FG4/VG4	+ \$116
Fabric/Vinyl Grade 5	FG5/VG5	+ \$172
Fabric/Vinyl Grade 6	FG6/VG6	+ \$213
Fabric/Vinyl Grade 7	FG7/VG7	+ \$254
Leather Grade 1	LG1	+ \$300
COL	COL	+ \$380
Leather Grade 2	LG2	+ \$380
Leather Grade 3	LG3	+ \$480

Please reference the [Textile Reference Guide](#) for pricing on fabric over grade 7 and leather over grade 3.

7. Packaging

Packaging	Code	Price
Knocked Down	KD	+ \$0
Back Attached to Seat, Base Separate	UC	+ \$80
Fully Assembled in a Carton	AC	+ \$200

EFFECTIVE NOVEMBER 4, 2024 | GSA SIN #: 33721

SPECIFICATIONS

	1203 BK1 MB S1 Task Stool	1203 BK1 MB S2 Extended Task Stool
Dimensions		
Overall Width Without Arms	26.25"	26.25"
Overall Width With Arms	26.25"	26.25"
Overall Depth	27"	27"
Overall Height	41.875"	44.75"
Seat Width	20"	20"
Seat Depth	17"	17"
Seat Height	21.375"-29"	24.25"- 34.25"
Back Width	19.25"	19.25"
Back Height	19.25"	19.25"
Materials		
COM	1 yd	1 yd
COL	17 sq ft	17 sq ft
Weight and Capacity		
Weight Armless	30 lb	31 lb
Weight With Arms	36 lb	37 lb
Weight Capacity	300 lb	300 lb



Good
Featured with Ocean mesh and
SitOnIt Seating's Dash - Dove

InFlex

LIGHT TASK CHAIR AND STOOL

Geometry in motion.

The InFlex™ light task chair and stool deliver task functionality with fun styling. Designer Giancarlo Piretti fused design and engineering to create the flexback disc system that follows the spine's natural curve. A stylish, comfortable and affordable standout in a creative office space or anywhere collaboration is called for.



EFFECTIVE NOVEMBER 4, 2024

Featured Models

GOOD :: \$501

Task chair, all plastic seat and back, basic mechanism, armless, carpet casters

BETTER :: \$566

Task chair, plastic back, upholstered seat, basic mechanism, armless, carpet casters, grade 1 textile



BEST :: \$689

Task chair, upholstered seat and back, basic mechanism, fixed task arms, carpet casters, grade 1 textile



Features

- Giancarlo Piretti design
- Innovative disc system emulates the human spine
- Fully upholstered, upholstered seat or plastic
- Nine plastic colors
- Two frame finishes
- CAL 133 approved models
- 300 lb weight capacity warranty
- Complements InFlex multipurpose chair, counter and bar stool; see [page 248](#)

1. Back

Back and Seat Style	Code	Price	
Plastic	No Code	\$501	
Upholstered Seat	US	\$566	
Upholstered Seat and Back	UP	\$631	

2. Frame

Frame Type	Code	Price	
Task Chair	973B	+ \$0	
Task Stool	973B S1	+ \$150	
Extended Task Stool	973B S2	+ \$174	



LIGHT TASK CHAIR AND STOOL

2. Frame (Cont.)

Frame Finish	Code	Price	
Black	FC1	+ \$0	
Silver	FC2	+ \$35	

InFlex task models come with basic mechanism (swivel only).

3. Arms

Arm Style	Code	Price	
Armless	A0	+ \$0	
Fixed Task Arms	A122	+ \$58	

4. Base

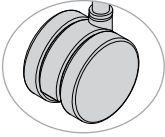
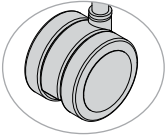
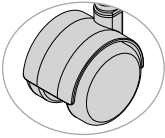
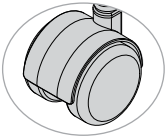
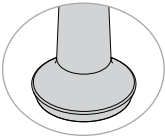
Casters or Glides	Code	Price	
Casters			
Carpet Casters	C15	+ \$0	
Hard Floor and Carpet Casters	C14	+ \$40	
Self-Locking Carpet Casters	C20	+ \$30	
Self-Locking Hard Floor and Carpet Casters	C19	+ \$64	
Glides			
Glides for Task Chairs	C3	+ \$30	

Self-locking casters (C19/C20) lock only when not in use.

5. Material

Protection	Code	Price
Fire Retardancy		
CAL 133, Fabric, Quantities 1–49	133F	+ \$99
CAL 133, Fabric, Quantities 50+	133F5	+ \$55
CAL 133, Plastic, Any Quantity	133P	+ \$45
Shell Color	Code	Price
Arctic	SC21	+ \$0
Black	SC1	+ \$0
Chocolate	SC4	+ \$0
Lagoon	SC15	+ \$0
Latte	SC20	+ \$0
Navy	SC5	+ \$0
Red	SC19	+ \$0
Slate	SC8	+ \$0
Sterling	SC18	+ \$0
Textile	Code	Price
Seat Textile Only (For US)		
Fabric/Vinyl Grade 1	FG1/VG1	+ \$0
COM	COM	+ \$24
Fabric/Vinyl Grade 2	FG2/VG2	+ \$24
Fabric/Vinyl Grade 3	FG3/VG3	+ \$45
Fabric/Vinyl Grade 4	FG4/VG4	+ \$77
Fabric/Vinyl Grade 5	FG5/VG5	+ \$116
Fabric/Vinyl Grade 6	FG6/VG6	+ \$159
Fabric/Vinyl Grade 7	FG7/VG7	+ \$200
Seat and Back Textile (For UP)		
Fabric/Vinyl Grade 1	FG1/VG1	+ \$0
COM	COM	+ \$36
Fabric/Vinyl Grade 2	FG2/VG2	+ \$36
Fabric/Vinyl Grade 3	FG3/VG3	+ \$74
Fabric/Vinyl Grade 4	FG4/VG4	+ \$121
Fabric/Vinyl Grade 5	FG5/VG5	+ \$174
Fabric/Vinyl Grade 6	FG6/VG6	+ \$235
Fabric/Vinyl Grade 7	FG7/VG7	+ \$296

Please reference the [Textile Reference Guide](#) for pricing on fabric over grade 7. Additional CAL 133 information can be found on [page 15](#).

Please reference the [Fabric information](#) found on [page 17](#) for pricing on multi-upholstery.

LIGHT TASK CHAIR AND STOOL

6. Packaging

Packaging	Code	Price
Back Attached to Seat, Base Separate	UC	+ \$0

SPECIFICATIONS

	973B Task Chair	973B S1 Task Stool	973B S2 Extended Task Stool
Dimensions			
Overall Width Armless	19.75"	19.75"	19.75"
Overall Width With Arms	25"	25"	25"
Overall Depth	22.25"	22.25"	22.25"
Overall Height	32.5"	38.5"	42.5"
Seat Width	16.75"	16.75"	16.75"
Seat Depth	18.5"	18.5"	18.5"
Seat Height	16.5"–21.5"	20"–28"	24.5"–34.5"
Back Width	19.75"	19.75"	19.75"
Back Height	15.5"	15.5"	15.5"
Materials			
COM	0.85 yd (US) 1 yd (UP)	0.85 yd (US) 1 yd (UP)	0.85 yd (US) 1 yd (UP)
COL	10 sq ft (US) 15 sq ft (UP)	10 sq ft (US) 15 sq ft (UP)	10 sq ft (US) 15 sq ft (UP)
Weight and Capacity			
Weight Armless	15 lb	16.5 lb	16.5 lb
Weight With Arms	19 lb	20.5 lb	20.5 lb
Weight Capacity Warranty	300 lb	300 lb	300 lb

Upholstered seat only (US). Upholstered seat and back (UP).

Ioniq

COLLABORATIVE CHAIR

Inspire unique.

There's a specialness that flows through Ioniq™. Its form and feeling are fluid—from the way the arms stretch seamlessly out of a sculpted shell to base options that are as varied and versatile as the spaces they occupy. Because when you desire aesthetics that elevate any experience and offer something refreshingly different, there's only one go-to. And that's Ioniq.



EFFECTIVE NOVEMBER 4, 2024

Featured Models

GOOD :: \$861

Plastic back, upholstered seat, integrated arms, height-adjustable mechanism with swivel and tilt, 5-star nylon base, carpet casters, grade 1 textile

BETTER :: \$980

Plastic back, upholstered seat, integrated arms, height-adjustable mechanism with swivel and tilt, 5-star polished aluminum, carpet casters, grade 1 textile

Features

- Breathable back with built-in lumbar support
- Minimalist-designed mechanism with streamlined controls
- Edge-to-edge cushion
- Fully integrated armrests
- Single-piece sculpted shell
- 5-star base
- Performance casters
- 300 lb weight capacity warranty
- Complements Ioniq Guest and Ioniq Side; see [page 252](#) and [page 254](#)

1. Frame

Frame Type	Code	Price	
Collaborative Task (5-Star Base)	1152 FT3	\$861	

Seat and Back Style	Code	Price	
Plastic Back With Upholstered Seat Pad	US PB	+ \$0	

Shell Color	Code	Price	
Black	SC1	+ \$0	
White	SC26	+ \$0	

2. Base

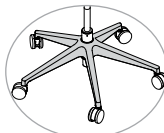
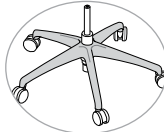
Base Type and Material	Code	Price	
5-Star Nylon	BT1	+ \$0	
5-Star Polished Aluminum	BT2	+ \$119	

COLLABORATIVE CHAIR

2. Base (Cont.)

Base Color	Code	Price	
Black Nylon Base	BC1	+ \$0	
White Nylon Base	BC3	+ \$0	
Casters	Code	Price	
Carpet Casters	CS5	+ \$0	
Hard Floor and Carpet Casters	CS6	+ \$45	

Black nylon base (BC1) available with black shell (SC1) only. White nylon base (BC3) available with white shell (SC26) only.

Caster color will correspond to shell color.

3. Mechanism

Mechanism Style	Code	Price	
Height-Adjustable With Swivel and Tilt	T	+ \$0	

4. Material

Seat Textile	Code	Price	
Fabric/Vinyl Grade 1	FG1/VG1	+ \$0	
COM	COM	+ \$24	
Fabric/Vinyl Grade 2	FG2/VG2	+ \$24	
Fabric/Vinyl Grade 3	FG3/VG3	+ \$45	
Fabric/Vinyl Grade 4	FG4/VG4	+ \$77	
Fabric/Vinyl Grade 5	FG5/VG5	+ \$116	
Fabric/Vinyl Grade 6	FG6/VG6	+ \$159	
Fabric/Vinyl Grade 7	FG7/VG7	+ \$200	
Leather Grade 1	LG1	+ \$140	
COL	COL	+ \$200	
Leather Grade 2	LG2	+ \$200	
Leather Grade 3	LG3	+ \$280	

Please reference the [Textile Reference Guide](#) for pricing on fabric over grade 7 and leather over grade 3.

EFFECTIVE NOVEMBER 4, 2024 | GSA SIN #: 33721

5. Packaging

Packaging	Code	Price
Back Attached to Seat, Base Separate	UC	+ \$0
Fully Assembled in a Carton	AC	+ \$120

SPECIFICATIONS

	1152 FT3 Collaborative Chair
Dimensions	
Overall Width	28"
Overall Depth	28"
Overall Height	33.75"-37.5"
Seat Width	17.5"
Seat Depth	17.38"
Seat Height	17.5"-21.25"
Back Width	18"
Back Height	17.38"
Materials	
COM	0.75 yd
COL	7 sq ft
Weight and Capacity	
Weight	18.5 lb
Weight Capacity Warranty	300 lb

Chair is widest at the base.



Knack

UPHOLSTERED BACK TASK CHAIR

Smart choice. Everyday.

Knack™ boasts an uncluttered and traditional design that makes it an essential and affordable choice for corporate, healthcare, government and educational settings. The soft, comfortable back follows the natural curve of the spine, providing great support for hours of sitting. Five control selections and a Heavy Duty 24/7 option make Knack a great all-around task chair. Knack includes a back-height adjustment so every user can enjoy individualized upper-back and lumbar support.



EFFECTIVE NOVEMBER 4, 2024

Featured Models

GOOD :: \$862

Swivel-tilt mechanism, fixed arms, nylon base, grade 1 textile

BETTER :: \$922

Enhanced synchro mechanism, height-adjustable arms, nylon base, grade 1 textile

BEST :: \$1,036

Enhanced synchro mechanism with seat-depth adjustment, height-/width-adjustable arms, nylon base, grade 1 textile

Features

- Durable and ergonomic
- Internal back-height adjustment (on Y and M mechanisms only)
- Ballistic nylon back (optional)
- Brushed aluminum, polished aluminum or nylon base
- Waterfall seat
- 300 lb weight capacity warranty;
350 lb Heavy Duty weight capacity warranty

1. Back

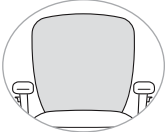
Back Size and Style	Code	Price	
Midback Task Chair	3323	\$922	



2. Super Duty

Super Duty Series	Code	Price	
Heavy Duty	HD	+ \$200	

Must select multi-function (M) or enhanced synchro (Y) mechanism. Not available with fixed loop (A77) arm. See the Super Duty Guide on [page 626](#) for additional LT and HD options.

UPHOLSTERED BACK TASK CHAIR



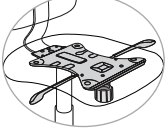
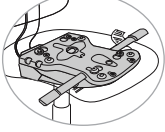
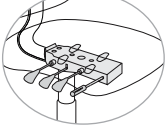
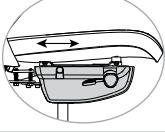
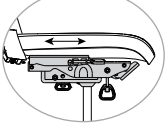

3. Mechanism

Mechanism Style	Code	Price	
Basic (Swivel Only)	B	- \$65	
Swivel-Tilt	T	- \$50	
Standard Synchro	F	- \$35	
Enhanced Synchro	Y	+ \$0	
Multi-Function	M	+ \$36	
Enhanced Synchro With Seat-Depth Adjustment	Y E3	+ \$79	
Multi-Function With Seat-Depth Adjustment	M E3	+ \$115	

4. Arms



Arm Style	Code	Price	
Armless	A0	- \$80	
Fixed Loop	A77	- \$10	
Height-Adjustable	A80	+ \$0	
Height-/Width-Adjustable	A81	+ \$35	

5. Base

Base Color and Material	Code	Price	
Black Nylon Base	B0	+ \$0	
Black Nylon Base, 26"	B7	+ \$0	
Brushed Aluminum Base	B2	+ \$119	
Polished Aluminum Base	B5	+ \$169	

UPHOLSTERED BACK TASK CHAIR

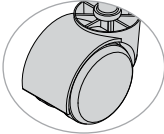
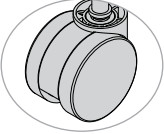
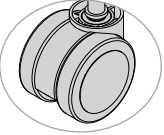
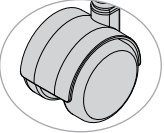
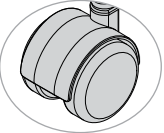
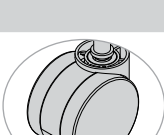
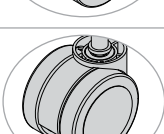
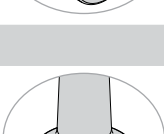
5. Base (Cont.)

Casters or Glides	Code	Price	
Casters			
Carpet Casters	C5	+ \$0	
Hard Floor and Carpet Casters	C1	+ \$45	
Heavy Duty Carpet Casters	C11	+ \$30	
Heavy Duty Hard Floor and Carpet Casters	C9	+ \$61	
Self-Locking Carpet Casters	C2	+ \$30	
Self-Locking Hard Floor and Carpet Casters	C7	+ \$61	
Heavy Duty Casters (For HD Models)			
Heavy Duty Carpet Casters	C11	+ \$0	
Heavy Duty Hard Floor and Carpet Casters	C9	+ \$61	
Glides			
Glides for Task Chairs	C3	+ \$35	

Black nylon base (B0) and polished aluminum base (B5) are not available for Heavy Duty (HD) option.

Self-locking casters (C2/C7) lock only when not in use.

6. Material

Protection	Code	Price
Fire Retardancy		
CAL 133, Fabric, Quantities 1-49	133F	+ \$99
CAL 133, Fabric, Quantities 50+	133F5	+ \$55
CAL 133, Leather, Any Quantity	133L	+ \$119
Ballistic Nylon Back	Code	Price
Ballistic Nylon Back	BN	+ \$0
Seat and Back Textile	Code	Price
Fabric/Vinyl Grade 1	FG1/VG1	+ \$0
COM	COM	+ \$40
Fabric/Vinyl Grade 2	FG2/VG2	+ \$40
Fabric/Vinyl Grade 3	FG3/VG3	+ \$74
Fabric/Vinyl Grade 4	FG4/VG4	+ \$121
Fabric/Vinyl Grade 5	FG5/VG5	+ \$174
Fabric/Vinyl Grade 6	FG6/VG6	+ \$235
Fabric/Vinyl Grade 7	FG7/VG7	+ \$296
Leather Grade 1	LG1	+ \$320
COL	COL	+ \$420
Leather Grade 2	LG2	+ \$420
Leather Grade 3	LG3	+ \$540

Please reference the [Textile Reference Guide](#) for pricing on fabric over grade 7 and leather over grade 3. Additional CAL 133 information can be found on [page 15](#).

Please reference the [Fabric information](#) found on [page 17](#) for pricing on multi-upholstery.

7. Packaging

Packaging	Code	Price
Knocked Down	KD	+ \$0
Back Attached to Seat, Base Separate	UC	+ \$80
Fully Assembled in a Carton	AC	+ \$200

UPHOLSTERED BACK TASK CHAIR

SPECIFICATIONS

	3323 Midback Task Chair
Dimensions	
Overall Width	26"
Overall Depth	26"
Overall Height	34.5" (T/F) 35.5" (Y/M)
With Aluminum Base	35" (T/F) (B2) 36" (Y/M) (B2)
Seat Width	20.5"
Seat Depth	18"
Seat Height	16.5"-21" (T/F/M) 17.5"-22" (Y) 17"-21.5" (T/F/M) (B2/B5) 18"-22.5" (Y) (B2/B5)
Back Width	20"
Back Height	19.5"
Materials	
COM	1.85 yd 1.55 yd (BN)
COL	32 sq ft 27 sq ft (BN)
Weight and Capacity	
Weight Armless	39 lb
Weight With Arms	45 lb
Weight Capacity Warranty	300 lb 350 lb (M/Y)(HD)

Swivel-tilt mechanism (T). Standard synchro mechanism (F). Enhanced synchro mechanism (Y). Multi-function mechanism (M). Brushed aluminum base (B2). Polished aluminum base (B5).

Knack

UPHOLSTERED BACK TASK STOOL

Smart choice. Everyday.

Knack™ boasts an uncluttered and traditional design that makes it an essential and affordable choice for corporate, healthcare, government and educational settings. The soft, comfortable back follows the natural curve of the spine, providing great support for hours of sitting. The Knack stool comes with three arm options and choice of standard black or polished aluminum base.



EFFECTIVE NOVEMBER 4, 2024

Featured Models

GOOD :: \$917

Midback stool, basic mechanism, armless, standard stool kit, black nylon base, carpet casters, grade 1 textile

BETTER :: \$997

Midback stool, basic mechanism, height-adjustable arms, standard stool kit, black nylon base, carpet casters, grade 1 textile

BEST :: \$1,056

Midback stool, basic mechanism, height-/width-adjustable arms, extended stool kit, black nylon base, carpet casters, grade 1 textile

Features

- Durable and ergonomic
- Ballistic nylon back (optional)
- Black nylon or polished aluminum base
- Waterfall seat
- 300 lb weight capacity

1. Back

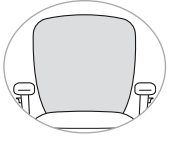
Back Size and Style	Code	Price	
Midback Task Stool With Basic Mechanism (Swivel Only)	3323B	\$997	



2. Arms

Arm Style	Code	Price	
Armless	A0	- \$80	
Fixed Loop	A77	- \$10	
Height-Adjustable	A80	+ \$0	
Height-/Width-Adjustable	A81	+ \$35	

UPHOLSTERED BACK TASK STOOL

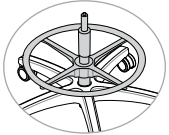
3. Base

Base	Code	Price	
Stool Kit	S1	+ \$0	
Extended Stool Kit	S2	+ \$24	

Base Color and Material	Code	Price	
Black Nylon Base	B0	+ \$0	
Polished Aluminum Base	B5	+ \$169	

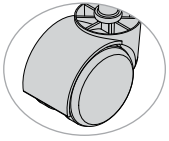
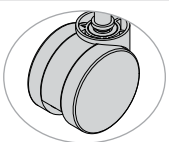
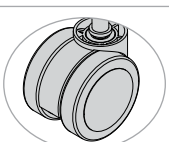
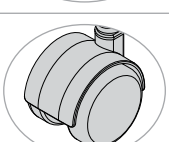
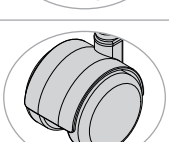
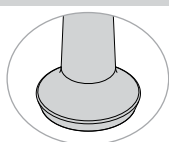
Casters or Glides	Code	Price	
Carpet Casters	C5	+ \$0	
Hard Floor and Carpet Casters	C1	+ \$45	
Heavy Duty Carpet Casters	C11	+ \$30	
Heavy Duty Hard Floor and Carpet Casters	C9	+ \$61	
Self-Locking Carpet Casters	C2	+ \$30	
Self-Locking Hard Floor and Carpet Casters	C7	+ \$61	
Glides			
Glides for Task Chairs	C3	+ \$35	

Self-locking casters (C2/C7) lock only when not in use.

UPHOLSTERED BACK TASK STOOL

4. Material

Protection	Code	Price
Fire Retardancy		
CAL 133, Fabric, Quantities 1–49	133F	+ \$99
CAL 133, Fabric, Quantities 50+	133F5	+ \$55
CAL 133, Leather, Any Quantity	133L	+ \$119
Ballistic Nylon Back	Code	Price
Ballistic Nylon Back	BN	+ \$0
Seat and Back Textile	Code	Price
Fabric/Vinyl Grade 1	FG1/VG1	+ \$0
COM	COM	+ \$40
Fabric/Vinyl Grade 2	FG2/VG2	+ \$40
Fabric/Vinyl Grade 3	FG3/VG3	+ \$74
Fabric/Vinyl Grade 4	FG4/VG4	+ \$121
Fabric/Vinyl Grade 5	FG5/VG5	+ \$174
Fabric/Vinyl Grade 6	FG6/VG6	+ \$235
Fabric/Vinyl Grade 7	FG7/VG7	+ \$296
Leather Grade 1	LG1	+ \$320
COL	COL	+ \$420
Leather Grade 2	LG2	+ \$420
Leather Grade 3	LG3	+ \$540

Please reference the [Textile Reference Guide](#) for pricing on fabric over grade 7 and leather over grade 3. Additional CAL 133 information can be found on [page 15](#).

Please reference the [Fabric information](#) found on [page 17](#) for pricing on multi-upholstery.

5. Packaging

Packaging	Code	Price
Knocked Down	KD	+ \$0
Back Attached to Seat, Base Separate	UC	+ \$80
Fully Assembled in a Carton	AC	+ \$200

SPECIFICATIONS

	3323 S1 Midback Task Stool	3323 S2 Extended Midback Task Stool
Dimensions		
Overall Width	27"	27"
Overall Depth	26.5"	26.5"
Overall Height With Aluminum Base	44" 44.5" (B5)	44" 44.5" (B5)
Seat Width	21.5"	21.5"
Seat Depth	18"	18"
Seat Height With Aluminum Base	19.5"–27.5" 20"–28" (B2)	23.5"–33.5" 24"–34" (B2)
Back Width	20.5"	20.5"
Back Height	19.5"	19.5"
Materials		
COM	1.85 yd 1.55 yd (BN)	1.85 yd 1.55 yd (BN)
COL	32 sq ft 27 sq ft (BN)	32 sq ft 27 sq ft (BN)
Weight and Capacity		
Weight Armless	53 lb	59 lb
Weight With Arms	67 lb	73 lb
Weight Capacity Warranty	300 lb	300 lb

Ballistic nylon back (BN). Polished aluminum base (B2).

Lavo

TASK CHAIR

Mesh with Design.

Breeze through your day on our lightweight Lavo and its twist on the all-mesh makeup. With an eye for elevating the working experience using core ergonomics, this design offers all-day comfort in a sophisticated design — including all the features and options to fit the modern office.



Best
Featured with an Electric Blue mesh.

EFFECTIVE NOVEMBER 4, 2024

Featured Models

GOOD :: \$888

Black frame, upholstered seat, no lumbar, height-adjustable arms, 5-star nylon base, carpet casters

BETTER :: \$1,170

Fog frame, mesh seat, adjustable lumbar, height-adjustable arms, 5-star nylon base, carpet casters

BEST :: \$1,240

White frame, mesh seat, adjustable lumbar, fully adjustable arms, 5-star nylon base, carpet casters

Features

- Ultra-breathable (almost transparent), bleach-cleanable mesh
- Sleek, contoured silhouette provides a modern aesthetic
- Floating synchro mechanism + mesh seat delivers responsive support
- Quick-access controls feature four locking positions, extending recline to 18 degrees
- Adjustable lumbar plus flexing upper frame offer extra comfort
- Flexible waterfall-edge seat with adjustable depth
- Extensive custom color options — frame, base, accents and mesh
- Optional upholstered seat available
- Lifetime warranty designed to exceed BIFMA x5.1-2017 durability standard
- 350 lb weight capacity warranty

1. Back

Back Size and Style	Code	Price	
---------------------	------	-------	--

Lavo Highback	1673 BK2	\$938	
---------------	----------	-------	---

Back Material	Code	Price	
---------------	------	-------	--

Mesh Back	MB	+ \$0	
-----------	----	-------	---

Headrest	Code	Price	
----------	------	-------	--

No Headrest	HR0	+ \$0	
-------------	-----	-------	--

Lumbar	Code	Price	
--------	------	-------	--

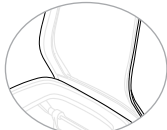
No Lumbar	LB0	- \$50	
-----------	-----	--------	---

Adjustable Lumbar	LB1	+ \$0	
-------------------	-----	-------	---

TASK CHAIR

2. Seat

Seat Material	Code	Price	
---------------	------	-------	--

Upholstered Seat	US	+ \$0	
------------------	----	-------	---

Mesh Seat	MS	+ \$187	
-----------	----	---------	---

Mechanism Style	Code	Price	
-----------------	------	-------	--

Floating Synchro With Seat Depth Adjustment	SF E3	+ \$0	
---	-------	-------	---

3. Frame

Frame Color	Code	Price	
-------------	------	-------	--

Black	FC1	+ \$0	
Fog	FC13	+ \$45	
White	FC12	+ \$45	

Accent Color	Code	Price	
--------------	------	-------	--

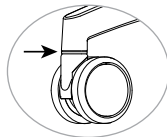
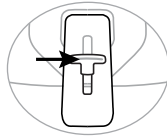
Apple	LA12	+ \$0	
Electric Blue	LA5	+ \$0	
Fire	LA6	+ \$0	
Fog	LA4	+ \$0	
Onyx	LA1	+ \$0	
Navy	LA15	+ \$0	
Tangerine	LA9	+ \$0	
White	LA13	+ \$0	

4. Arms

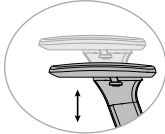
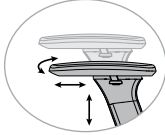
Arm Style	Code	Price	
Height-Adjustable (2-Way)	AR4	+ \$0	
Fully Adjustable (8-Way)	AR9	+ \$70	

5. Base

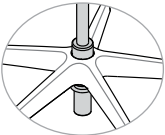
Cylinder Height	Code	Price	
Standard Cylinder	CH1	+ \$0	
Higher Cylinder	CH3	+ \$0	
Lower Cylinder	CH4	+ \$0	

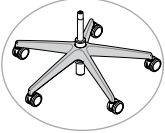
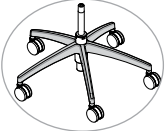
Base Style	Code	Price	
5-Star Nylon	BT1	+ \$0	
5-Star Polished Aluminum (for Any Frame Color)	BT2	\$119	

Base Color	Code	Price	
Black Nylon Base	BC1	\$0	
Fog Nylon Base	BC4	\$0	
White Nylon Base	BC3	\$0	

Lower cylinder (CH4) is only available in black. Style of nylon base will change with lower cylinder

Nylon base color must match frame color. Aluminum base (B18) can be used with any frame color. Polished aluminum base (B18) is not available with lower cylinder (CH4).

TASK CHAIR

5. Base

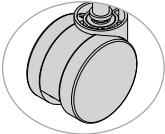
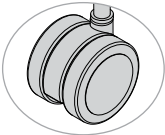
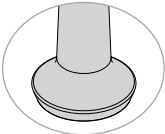
Casters	Code	Price	
Carpet Casters	CS5	+ \$0	
Hard Floor and Carpet Casters	CS6	+ \$45	
Glides for Task Chairs	CS3	+ \$35	

Caster color coordinates with frame color. Lower cylinder (CH4) is not available with polished aluminum base (B18).

6. Material

Mesh Color	Code	Price	
Apple	MC31	+ \$0	
Desert	MC9	+ \$0	
Electric Blue	MC13	+ \$0	
Fire	MC10	+ \$0	
Fog	MC7	+ \$0	
Navy	MC8	+ \$0	
Nickel	MC6	+ \$0	
Ocean	MC29	+ \$0	
Onyx	MC5	+ \$0	
Tangerine	MC28	+ \$0	

Seat and Back Textile	Code	Price	
Fabric/Vinyl Grade 1	FG1/VG1	+ \$0	
COM	COM	+ \$30	
Fabric/Vinyl Grade 2	FG2/VG2	+ \$30	
Fabric/Vinyl Grade 3	FG3/VG3	+ \$60	
Fabric/Vinyl Grade 4	FG4/VG4	+ \$116	
Fabric/Vinyl Grade 5	FG5/VG5	+ \$172	
Fabric/Vinyl Grade 6	FG6/VG6	+ \$213	
Fabric/Vinyl Grade 7	FG7/VG7	+ \$254	
Leather Grade 1	LG1	+ \$300	
COL	COL	+ \$380	
Leather Grade 2	LG2	+ \$380	
Leather Grade 3	LG3	+ \$480	

Please reference the [Textile Reference Guide](#) for pricing on fabric over grade 7 and leather over grade 3. Additional CAL 133 information can be found on [page 15](#).

EFFECTIVE NOVEMBER 4, 2024 | GSA SIN #: 33721

6. Packaging

Packaging	Code	Price
Knocked Down	KD	+ \$0
Back Attached to Seat, Base Separate	UC	+ \$80
Fully Assembled in a Carton	AC	+ \$200

SPECIFICATIONS

	1673 BK2 MS All Mesh	1673 BK2 US Upholstered Seat
Dimensions		
Overall Width With Arms	29.5" (BT1) 27.5" (BT2)	29.5" (BT1) 27.5" (BT2)
Overall Depth	27" (BT1) 25" (BT2)	27" (BT1) 25" (BT2)
Overall Height	39"-42.5" (BT1) 39.5"-42.5" (BT2)	39"-42.5" (BT1) 39.5"-42.5" (BT2)
Seat Width	19.75" (BT1) 19" (BT2)	19.75" (BT1) 19" (BT2)
Seat Depth	16.75"-18.75"	16.75"-18.75"
Seat Height	15"-17" (CH4) 17"-20.5" (CH1, BT1) 17.5"-20.5" (CH1, BT2) 19"-23.5" (CH3, BT1) 19.5"-24" (CH3, BT2)	15.75"-17.75" (CH4) 17.75"-21.25" (CH1, BT1) 18.25"-21.25" (CH1, BT2) 19.75"-24.25" (CH3, BT1) 20.25"-24.75" (CH3, BT2)
Back Width	17.5"	17.5"
Back Height	22"	22"
Materials		
COM	NA	1 yd
COL	NA	18 sq ft
Weight and Capacity		
Weight	38 lb	37 lb
Weight Capacity Warranty	350 lb	350 lb

Standard cylinder (CH1). Higher cylinder (CH3). Lower cylinder (CH4). Nylon base (BT1).
Polished aluminum base (BT2).



Better
Featured with a Navy mesh.

Lumin

LIGHT TASK CHAIR AND STOOL

Light up the room.

Lumin™ is an elegant chair designed for exceptional support and comfort in corporate and education applications. The contoured seat dissipates pressure points for greater comfort while the perforated back adds contemporary style and comfortable breathability. The Lumin light task chair and light task stool are available in black or silver frame finish with matching arm pad colors. Refined, sophisticated Lumin will light up the room.



*Plastic Back With Upholstered Seat
Featured with a Tangerine shell and SitOnIt Seating's Venice — Sundown*

EFFECTIVE NOVEMBER 4, 2024

Featured Models

PLASTIC :: \$469

Task chair, all plastic seat and back, basic mechanism, armless, black frame, carpet casters

PLASTIC BACK WITH UPHOLSTERED SEAT :: \$627

Task chair, plastic back, upholstered seat, basic mechanism, fixed arms, silver frame, carpet casters, grade 1 textile

UPHOLSTERED SEAT AND BACK :: \$657

Task chair, upholstered seat and back, basic mechanism, fixed arms, black frame, carpet casters, grade 1 textile

Features

- Contemporary design
- Exceptional support and comfort
- Fully upholstered, upholstered seat or plastic
- 14 plastic shell colors
- Two frame finishes with matching arm pads
- Built-in pull handle
- Cleanout space
- 300 lb weight capacity warranty
- Complements Lumin multipurpose chair, counter and bar stool; see [page 258](#)



LIGHT TASK CHAIR AND STOOL

1. Back



Back and Seat Style	Code	Price	
Plastic Seat	PS	\$469	
Upholstered Seat Only	US	\$534	
Upholstered Seat and Back	UP	\$599	

2. Frame

Frame Type	Code	Price	
Task	1012 FT3	+\$0	
Task Stool	1012 FT3 S21	+\$150	
Extended Task Stool	1012 FT3 S22	+\$174	
Frame Finish	Code	Price	
Black	FC1	+\$0	
Silver	FC2	+\$35	

Lumin task comes with basic mechanism (swivel only).

3. Arms

Arm Style	Code	Price	
Armless	A0	+ \$0	
Fixed	A147	+ \$58	

4. Base

Base Color and Material	Code	Price	
Black Nylon Base (For Black Frame FC1)	B17	+ \$0	
Fog Nylon Base (For Silver Frame FC2)	B21	+ \$0	

Casters or Glides	Code	Price	
Casters			

Carpet Casters	C15	+ \$0	
----------------	-----	-------	---

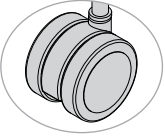
Hard Floor and Carpet Casters	C14	+ \$40	
-------------------------------	-----	--------	---

Self-Locking Carpet Casters	C20	+ \$30	
-----------------------------	-----	--------	---

Self-Locking Hard Floor and Carpet Casters	C19	+ \$64	
--	-----	--------	---

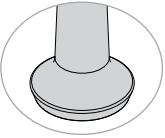
Glides			
Glides for Task Chairs	C3	+ \$30	

Self-locking casters (C19/C20) lock only when not in use.

LIGHT TASK CHAIR AND STOOL

5. Material

Protection	Code	Price	
Fire Retardancy			
CAL 133, Fabric, Quantities 1–49	133F	+ \$64	
CAL 133, Fabric, Quantities 50+	133F5	+ \$20	
CAL 133, Plastic, Any Quantity	133P	+ \$10	

Shell Color	Code	Price	
Apple	SC24	+ \$0	
Arctic	SC21	+ \$0	
Bisque	SC7	+ \$0	
Black	SC1	+ \$0	
Chocolate	SC4	+ \$0	
Lagoon	SC15	+ \$0	
Latte	SC20	+ \$0	
Lemon	SC25	+ \$0	
Navy	SC5	+ \$0	
Pacific	SC22	+ \$0	
Red	SC19	+ \$0	
Slate	SC8	+ \$0	
Sterling	SC18	+ \$0	
Tangerine	SC23	+ \$0	

Textile	Code	Price	
Seat Textile Only (For US)			
Fabric/Vinyl Grade 1	FG1/VG1	+ \$0	
COM	COM	+ \$24	
Fabric/Vinyl Grade 2	FG2/VG2	+ \$24	
Fabric/Vinyl Grade 3	FG3/VG3	+ \$45	
Fabric/Vinyl Grade 4	FG4/VG4	+ \$77	
Fabric/Vinyl Grade 5	FG5/VG5	+ \$116	
Fabric/Vinyl Grade 6	FG6/VG6	+ \$159	
Fabric/Vinyl Grade 7	FG7/VG7	+ \$200	

5. Material (Cont.)

Textile	Code	Price
Seat and Back Textile (For UP)		
Fabric Grade 1	FG1/VG1	+ \$0
COM	COM	+ \$36
Fabric/Vinyl Grade 2	FG2/VG2	+ \$36
Fabric/Vinyl Grade 3	FG3/VG3	+ \$74
Fabric/Vinyl Grade 4	FG4/VG4	+ \$121
Fabric/Vinyl Grade 5	FG5/VG5	+ \$174
Fabric/Vinyl Grade 6	FG6/VG6	+ \$235
Fabric/Vinyl Grade 7	FG7/VG7	+ \$296

Please reference the [Textile Reference Guide](#) for pricing on fabric over grade 7. Additional CAL 133 information can be found on [page 15](#).

Please reference the Fabric information found on [page 17](#) for pricing on multi-upholstery.



Upholstered
Seat and Back

LIGHT TASK CHAIR AND STOOL

6. Packaging

Packaging	Code	Price
Back Attached to Seat, Base Separate	UC	+ \$0
Fully Assembled In a Carton	AC	+ \$120

SPECIFICATIONS

	1012 FT3 Task Chair	1012 FT3 S21 Task Stool	1012 FT3 S22 Extended Task Stool
Dimensions			
Overall Width	26.8"	26.8"	26.8"
Overall Width With Arms	26.8"	26.8"	26.8"
Overall Depth	26.8"	26.8"	26.8"
Overall Height	31.7"-36.7"	37.7"-45.7"	41.7"-51.7"
Seat Width	19"	19"	19"
Seat Depth	18.7"	18.7"	18.7"
Seat Height	16.62"-21.75"	18"-26"	23"-33"
Back Width	18.3"	18.3"	18.3"
Back Height	16.7"	16.7"	16.7"
Materials			
Weight Armless	20.5"	25.1"	26"
Weight With Arms	22.2"	26.8"	27.7"
COM	0.85 yd (US) 1 yd (UP)	0.85 yd (US) 1 yd (UP)	0.85 yd (US) 1 yd (UP)
COL	10 sq ft (US) 15 sq ft (UP)	10 sq ft (US) 15 sq ft (UP)	10 sq ft (US) 15 sq ft (UP)
Weight and Capacity			
Weight Armless	20.5"	25.1"	26"
Weight With Arms	22.2"	26.8"	27.7"
Weight Capacity Warranty	300 lb	300 lb	300 lb

Upholstered seat only (US). Upholstered seat and back (UP).

Mavic

COLLABORATIVE CHAIR

Cross over collaboration.

Mavic™ is here to prove that a jack-of-all-trades can be a master of all. Looks, features, function, comfort and more—there's so much Mavic offers in a single, light-scale seat that it crosses over into new territory. So when it's time to enable collaboration (wherever and whenever you need it), Mavic sits ready to provide a radical new way to work.



Better
Featured with Ocean mesh and
SitOnIt Seating's Dash – Dove

EFFECTIVE NOVEMBER 4, 2024

Featured Models

GOOD :: \$862

Floating mesh back with integrated arms, swivel-tilt mechanism, black frame and black nylon base, caster ring accent color, carpet casters, grade 1 textile

BETTER :: \$954

Floating mesh back with integrated arms, weight-activated mechanism with override, tilt limiter and seat slider, white frame and white nylon base, caster ring accent color, carpet casters, grade 1 textile

Features

- Designed by Martin Ballendat
- Slim, single-piece frame design
- Swivel-tilt or weight-activated mechanism
- Eight-hour endurance cushion with 15,000+ textile options
- Built-in lumbar support from tension mesh
- Tapered seat pan with almost-invisible controls
- Advanced adjustments include seat slider and tilt limiter/override
- Performance caster colors coordinate with the frame and base
- Three frame and base, 10 mesh and 12 accent color options
- 300 lb weight capacity warranty

1. Back

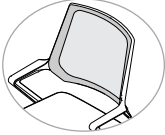
Back Size and Style	Code	Price	
Midback Mesh	1113 MB	\$862	

2. Mechanism

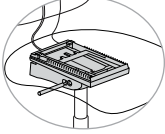
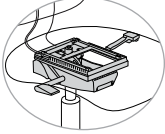
Mechanism	Code	Price	
Swivel-Tilt	T	+ \$0	
Weight-Activated With Override, Tilt Limiter and Seat Slider	WA	+ \$47	

COLLABORATIVE CHAIR

3. Frame

Frame Color	Code	Price	
Black	FC1	+ \$0	
Fog	FC13	+ \$45	
White	FC12	+ \$45	

4. Base

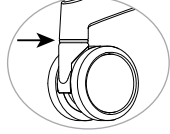
Accent Color	Code	Price	
Apple	LA12	+ \$0	
Desert	LA3	+ \$0	
Electric Blue	LA5	+ \$0	
Fire	LA6	+ \$0	
Fog	LA4	+ \$0	
Graphite	LA14	+ \$0	
Navy	LA15	+ \$0	
Nickel	LA2	+ \$0	
Ocean	LA10	+ \$0	
Onyx	LA1	+ \$0	
Tangerine	LA9	+ \$0	
White	LA13	+ \$0	

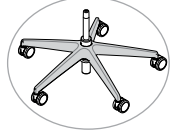
Base Style	Code	Price	
5-Star Nylon	BT1	+ \$0	

5-Star Polished Aluminum	BT2	+ \$119	
--------------------------	-----	---------	---

Base Color	Code	Price	
Black Nylon Base	BC1	+ \$0	
Fog Nylon Base	BC4	+ \$0	
White Nylon Base	BC3	+ \$0	

4. Base (Cont.)

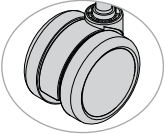
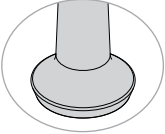
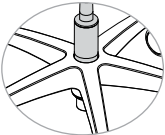
Casters or Glides	Code	Price	
Casters			
Carpet Casters	CS5	+ \$0	
Hard Floor and Carpet Casters	CS6	+ \$45	
Glides			
Glides for Task Chairs	CS3	+ \$35	
Cylinder Height			
Standard Cylinder	CH1	+ \$0	

Accent color will apply to caster rings.

Frame, base and caster color will correspond when the nylon base (BT1) is selected.

5. Material

Protection	Code	Price	
Fire Retardancy			
CAL 133, Fabric, Quantities 1–49	133F	+ \$99	
CAL 133, Fabric, Quantities 50+	133F5	+ \$55	
CAL 133, Leather, Any Quantity	133L	+ \$119	
Mesh Color			
Apple	MC31	+ \$0	
Desert	MC9	+ \$0	
Electric Blue	MC13	+ \$0	
Fire	MC10	+ \$0	
Fog	MC7	+ \$0	
Navy	MC8	+ \$0	
Nickel	MC6	+ \$0	
Ocean	MC29	+ \$0	
Onyx	MC5	+ \$0	
Tangerine	MC28	+ \$0	

COLLABORATIVE CHAIR

5. Material

Seat Textile	Code	Price	
Fabric/Vinyl Grade 1	FG1/VG1	+ \$0	
COM	COM	+ \$30	
Fabric/Vinyl Grade 2	FG2/VG2	+ \$30	
Fabric/Vinyl Grade 3	FG3/VG3	+ \$60	
Fabric/Vinyl Grade 4	FG4/VG4	+ \$116	
Fabric/Vinyl Grade 5	FG5/VG5	+ \$172	
Fabric/Vinyl Grade 6	FG6/VG6	+ \$213	
Fabric/Vinyl Grade 7	FG7/VG7	+ \$254	
Leather Grade 1	LG1	+ \$300	
COL	COL	+ \$380	
Leather Grade 2	LG2	+ \$380	
Leather Grade 3	LG3	+ \$480	

Please reference the [Textile Reference Guide](#) for pricing on fabric over grade 7 and leather over grade 3. Additional CAL 133 information can be found on [page 15](#).

6. Packaging

Packaging	Code	Price	
Back Attached to Seat, Base Separate	UC	+ \$0	
Fully Assembled in a Carton	AC	+ \$120	

SPECIFICATIONS

	1113 MB
Dimensions	
Overall Width With Arms	23.5"
Overall Depth	23.5"
Overall Height	35.4"
Seat Width	19"
Seat Depth	17.5"
Seat Height	17.5"–21.5"
Back Width	20"
Back Height	20"
Materials	
COM	0.8 yd
COL	14 sq ft
Weight and Capacity	
Weight With Arms	24.5 lb
Weight Capacity	300 lb

Movi

LIGHT TASK CHAIR AND STOOL

Movement-inspired. Collaboration-friendly.

For all those quick touch bases that end up being anything but, there's the Movi™ light task chair—an agile task chair that can adapt quickly to a constantly changing environment. Whether you need to quickly set up (or clean up), we've got a chair that can keep up.



EFFECTIVE NOVEMBER 4, 2024

Featured Models

MESH BACK CHAIR :: \$899

Task chair, mesh back, upholstered seat, basic mechanism, fixed loop arms, white frame, carpet casters, grade 1 textile

UPHOLSTERED BACK CHAIR :: \$903

Task chair, upholstered back and seat in grade 1 textile, basic mechanism, fixed arms, black frame, carpet casters



MESH BACK STOOL :: \$1,014

Task stool, mesh back, upholstered seat, basic mechanism, fixed arms, black frame, carpet casters, grade 1 textile

Features

- Flexes at the hip 14 degrees for enhanced comfort
- Clean-out space for easy maintenance
- Bleach-cleanable mesh back (10:1)
- Upholstered back with outer plastic shell offers essential durability + cleanability
- 15,000+ textiles including bleach cleanable, multi-upholstery and more
- 12 breathable mesh options offer cool comfort
- Three base frame and caster colors
- Three back frame and arm colors
- Carpet, hard floor and carpet casters available
- 300 lb weight capacity warranty
- Complements Movi nester; see [page 267](#)



1. Model

Frame Type	Code	Price	
Task	1062 FT3	\$864	
Task Stool	1062 FT3 S21	\$1,014	
Extended Task Stool	1062 FT3 S22	\$1,038	

Movi task models come with basic mechanism (swivel only).



LIGHT TASK CHAIR AND STOOL

2. Back

Back Material	Code	Price	
Mesh Back	MB	+\$0	
Upholstered Back	UB	+\$39	

Back Frame Finish	Code	Price	
Black	SC1	+\$0	
Fog	SC27	+\$35	
White	SC26	+\$35	

3. Arms

Arm Style	Code	Price	
Armless	AR0	-\$49	
Fixed Loop Arms	AR1	+\$0	

Arms (AR1) will match frame color.

4. Base

Base Color and Material	Code	Price	
Black Nylon Base With Black Casters	B17	+\$0	
Fog Nylon Base With Fog Casters	B21	+\$0	
White Nylon Base With Fog/White Casters	B20	+\$0	

4. Base

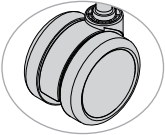
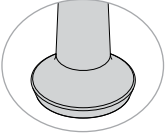
Casters or Glides	Code	Price	
Casters			
Carpet Casters	CS5	+ \$0	
Hard Floor and Carpet Casters	CS6	+ \$40	
Glides			
Bell Glides	CS20	+ \$30	

5. Material

Protection	Code	Price	
Fire Retardancy			
CAL 133, Fabric, Quantities 1-49	133F	+ \$99	
CAL 133, Fabric, Quantities 50+	133F5	+ \$55	
Mesh Color	Code	Price	
Apple	MC31	+ \$0	
Aqua	MC30	+ \$0	
Desert	MC22	+ \$0	
Electric Blue	MC24	+ \$0	
Fire	MC25	+ \$0	
Fog	MC23	+ \$0	
Grape	MC26	+ \$0	
Lemon	MC27	+ \$0	
Nickel	MC21	+ \$0	
Ocean	MC29	+ \$0	
Onyx	MC20	+ \$0	
Tangerine	MC28	+ \$0	
Fully Upholstered	Code	Price	
Mesh Back (Seat Only)			
Fabric/Vinyl Grade 1	FG1/VG1	+ \$0	
COM	COM	+\$24	
Fabric/Vinyl Grade 2	FG2/VG2	+\$24	
Fabric/Vinyl Grade 3	FG3/VG3	+\$45	
Fabric/Vinyl Grade 4	FG4/VG4	+\$77	
Fabric/Vinyl Grade 5	FG5/VG5	+\$116	
Fabric/Vinyl Grade 6	FG6/VG6	+\$159	
Fabric/Vinyl Grade 7	FG7/VG7	+\$200	

LIGHT TASK CHAIR AND STOOL

5. Material (Cont.)

Fully Upholstered	Code	Price	
Upholstered Back (Seat and Back)			
Fabric/Vinyl Grade 1	FG1/VG1	+ \$0	
COM	COM	+\$36	
Fabric/Vinyl Grade 2	FG2/VG2	+\$36	
Fabric/Vinyl Grade 3	FG3/VG3	+\$74	
Fabric/Vinyl Grade 4	FG4/VG4	+\$121	
Fabric/Vinyl Grade 5	FG5/VG5	+\$174	
Fabric/Vinyl Grade 6	FG6/VG6	+\$235	
Fabric/Vinyl Grade 7	FG7/VG7	+\$296	
Multi-Upholstery	Code	Price	
Multi-Upholstery Upcharge	UMU	+ \$58	
Seat Upholstery Only			
Fabric/Vinyl Grade 1	FG1/VG1	+ \$0	
COM	COM	+ \$24	
Fabric/Vinyl Grade 2	FG2/VG2	+ \$24	
Fabric/Vinyl Grade 3	FG3/VG3	+ \$45	
Fabric/Vinyl Grade 4	FG4/VG4	+ \$77	
Fabric/Vinyl Grade 5	FG5/VG5	+ \$116	
Fabric/Vinyl Grade 6	FG6/VG6	+ \$159	
Fabric/Vinyl Grade 7	FG7/VG7	+ \$200	
Back Upholstery Only			
Fabric/Vinyl Grade 1	FG1/VG1	+ \$0	
COM	COM	+\$20	
Fabric/Vinyl Grade 2	FG2/VG2	+\$20	
Fabric/Vinyl Grade 3	FG3/VG3	+\$39	
Fabric/Vinyl Grade 4	FG4/VG4	+\$63	
Fabric/Vinyl Grade 5	FG5/VG5	+\$91	
Fabric/Vinyl Grade 6	FG6/VG6	+\$123	
Fabric/Vinyl Grade 7	FG7/VG7	+\$154	

Please reference the [Textile Reference Guide](#) for pricing on fabric over grade 7. Additional CAL 133 information can be found on [page 15](#).

6. Packaging

Packaging	Code	Price	
Back Attached to Seat, Base Separate	UC	+ \$0	
Assembled in Bag (Southern California Only)	AB	+ \$0	
Assembled in Carton	AC	+ \$120	

EFFECTIVE NOVEMBER 4, 2024 | GSA SIN #: 33721

SPECIFICATIONS

	1062 FT3 Task Chair	1062 S21 Task Stool	1062 S22 Extended Task Stool
Dimensions			
Overall Width	26"	26"	26"
Overall Depth	26"	26"	26"
Overall Height	34.5" (MB) 24.75" (UB)	37.75" (MB) 38" (UB)	41" (MB) 41.25" (UB)
Seat Width	19"	19"	19"
Seat Depth	17"	17"	17"
Seat Height	17.5"-22.5"	21.5"-28.5"	24.5"-34"
Back Width	18"	18"	18"
Back Height	18" (MB) 18.25" (UB)	18" (MB) 18.25" (UB)	18" (MB) 18.25" (UB)
Materials			
COM (Back)	1 yd	1 yd	1 yd
COM (Seat)	1 yd	1 yd	1 yd
COM (Seat and Back)	1.25 yd	1.25 yd	1.25 yd
Weight and Capacity			
Weight Armless	22 lb	27 lb	28 lb
Weight With Arms	22 lb (MB) 27 lb (UB)	27 lb (MB) 32 lb (UB)	28 lb (MB) 33 lb (UB)
Weight Capacity Warranty	300 lb	300 lb	300 lb

Meshback (MB), Upholstered Back (UB)



Non-Stop Heavy Duty XL

TASK CHAIR

Around-the-clock comfort.

Designed for durability and backed by solid steel, Non-Stop™ differs from the typical chair construction in that all its mounting points are reinforced with heavy-gauge steel mounting brackets. These solid steel fasteners are second to none for reliability and ergonomic comfort in high-intensity environments where chairs perform all day, every day and support a wide range of users. This heavy duty chair is rated to accommodate users up to 500 pounds and easily handles the demands of 24-hour environments.



Best

EFFECTIVE NOVEMBER 4, 2024

Featured Models

GOOD :: \$2,411

Task size 3, dual torsion mechanism, armless, black aluminum base, carpet casters, grade 1 textile

BETTER :: \$2,561

Task size 3, dual torsion mechanism, large loop arms, black aluminum base, carpet casters, grade 1 textile

BEST :: \$2,730

Task size 3, dual torsion mechanism, large loop arms, polished aluminum base, carpet casters, grade 1 textile

Features

- Reinforced heavy gauge steel mounting brackets
- Resilient multilayer cushioning
- Waterfall seat promotes proper leg circulation
- Heavy-duty 24/7 option warranted to 500 lb weight capacity



1. Back

Back Size and Style	Code	Price	
Extra Large, 500 lb Capacity	673	\$2,561	

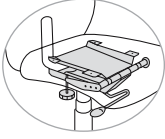
2. Mechanism

Mechanism Style	Code	Price	
Dual Torsion	DT	+ \$0	

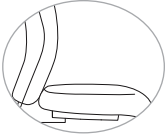
3. Arms

Arm Style	Code	Price	
Armless	A0	- \$150	
Large Loop	A72	+ \$0	

4. Base

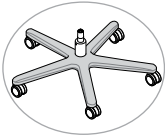
Base Color and Material	Code	Price	
Black Aluminum Base	B0	+ \$0	
Polished Aluminum Base	B5	+ \$169	

HEAVY DUTY TASK CHAIR

4. Base (Cont.)

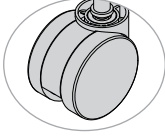
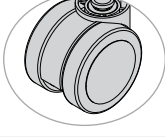
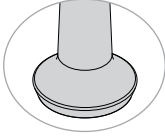
Casters or Glides	Code	Price	
Casters			
Heavy Duty Carpet Casters	C11	+ \$0	
Heavy Duty Hard Floor and Carpet Casters	C9	+ \$61	
Glides			
Glides for Task Chairs	C3	+ \$35	

5. Material

Protection	Code	Price	
Fire Retardancy			
CAL 133, Fabric, Quantities 1-49	133F	+ \$99	
CAL 133, Fabric, Quantities 50+	133F5	+ \$55	
Ballistic Nylon			
Ballistic Nylon Back	BN	+ \$0	
Seat and Back Textile			
Fabric/Vinyl Grade 1	FG1/VG1	+ \$0	
COM	COM	+ \$40	
Fabric/Vinyl Grade 2	FG2/VG2	+ \$40	
Fabric/Vinyl Grade 3	FG3/VG3	+ \$84	
Fabric/Vinyl Grade 4	FG4/VG4	+ \$156	
Fabric/Vinyl Grade 5	FG5/VG5	+ \$228	
Fabric/Vinyl Grade 6	FG6/VG6	+ \$304	
Fabric/Vinyl Grade 7	FG7/VG7	+ \$378	

Please reference the [Textile Reference Guide](#) for pricing on fabric over grade 7. Additional CAL 133 information can be found on [page 15](#).

Please reference the [Fabric information](#) found on [page 17](#) for pricing on multi-upholstery.

6. Packaging

Packaging	Code	Price	
Back Attached to Seat, Base Separate	UC	+ \$0	

HEAVY DUTY TASK CHAIR

SPECIFICATIONS

	673 Task Chair Size 3
Dimensions	
Overall Width	30"
Overall Depth	28.5"
Overall Height	39.5"
Seat Width	23"
Seat Depth	19.5"
Seat Height	20.375"-23.25"
Back Width	22"
Back Height	21.5" (DT)
Materials	
COM	2.5 yd 2 yd (BN)
COL	44 sq ft 35 sq ft (BN)
Weight and Capacity	
Weight Armless	67 lb (DT)
Weight With Arms	79 lb (DT)
Weight Capacity Warranty	500 lb

Ballistic nylon back (BN).



*Fixed Arms With
Black Base*

Non-Stop Heavy Duty XL

TASK STOOL

Around-the-clock comfort.

Designed for durability and backed by solid steel, Non-Stop™ differs from the typical chair construction in that all its mounting points are reinforced with heavy-gauge steel mounting brackets. These solid steel fasteners are second to none for reliability and ergonomic comfort in high-intensity environments where chairs perform all day, every day and support a wide range of users. This heavy duty chair is rated to accommodate users up to 500 pounds and easily handles the demands of 24-hour environments.



EFFECTIVE NOVEMBER 4, 2024

Featured Models

GOOD :: \$1,990

Size 1 task stool, basic mechanism, armless, black nylon base, carpet casters, grade 1 textile

BETTER :: \$2,140

Size 1 task stool, basic mechanism, height-adjustable arms, black nylon base, carpet casters, grade 1 textile

BEST :: \$2,368

Size 1 task stool, basic mechanism, height-/width-adjustable arms, extended stool kit, polished aluminum base, carpet casters, grade 1 textile

NON-STOP

EFFECTIVE NOVEMBER 4, 2024 | GSA SIN #: 33721

Features

- Reinforced heavy gauge steel mounting brackets
- Resilient multilayer cushioning
- Waterfall seat promotes proper leg circulation
- Heavy-duty 24/7 option warranted to 350 lb weight capacity

1. Back

Back Size and Style	Code	Price	
Heavy Duty Stool, 350 lb Capacity	671 B2	\$2,140	

Only available with the basic mechanism (swivel only).

2. Arms

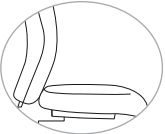
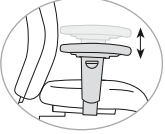
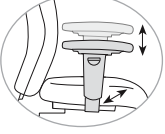

Arm Style	Code	Price	
Armless	A0	- \$150	
Height-Adjustable	A68	+ \$0	
Height-/Width-Adjustable	A69	+ \$35	

3. Base

Base	Code	Price	
Standard Stool Kit	S1HD	+ \$0	
Extended Stool Kit	S2HD	+ \$24	

HEAVY DUTY TASK STOOL

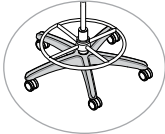
3. Base (Cont.)

Base Color and Material	Code	Price	
Black Nylon Base	B0	+ \$0	
Black Aluminum Base	B4	+ \$169	
Polished Aluminum Base	B5	+ \$169	

Casters or Glides	Code	Price	
Casters			

Heavy Duty Carpet Casters	C11	+ \$0	
Heavy Duty Hard Floor and Carpet Casters	C9	+ \$61	

Glides			
---------------	--	--	--

Glides for Task Chairs	C3	+ \$35	
------------------------	----	--------	---

4. Material (Cont.)

Protection	Code	Price
Fire Retardancy		
CAL 133, Fabric, Quantities 1–49	133F	+ \$99
CAL 133, Fabric, Quantities 50+	133F5	+ \$55
Ballistic Nylon	Code	Price
Ballistic Nylon Back	BN	+ \$0
Seat and Back Textile	Code	Price
Fabric/Vinyl Grade 1	FG1/VG1	+ \$0
COM	COM	+ \$40
Fabric/Vinyl Grade 2	FG2/VG2	+ \$40
Fabric/Vinyl Grade 3	FG3/VG3	+ \$84
Fabric/Vinyl Grade 4	FG4/VG4	+ \$156
Fabric/Vinyl Grade 5	FG5/VG5	+ \$228
Fabric/Vinyl Grade 6	FG6/VG6	+ \$304
Fabric/Vinyl Grade 7	FG7/VG7	+ \$378

Please reference the [Textile Reference Guide](#) for pricing on fabric over grade 7. Additional CAL 133 information can be found on [page 15](#).

Please reference the [Fabric information](#) found on [page 17](#) for pricing on multi-upholstery.

5. Packaging

Packaging	Code	Price
Knocked Down	KD	+ \$0
Back Attached to Seat, Base Separate	UC	+ \$80

HEAVY DUTY TASK STOOL

SPECIFICATIONS

	671B2 S1HD Task Stool	671B2 S2HD Extended Task Stool
Dimensions		
Overall Width	27.5"	27.5"
Overall Depth	26.5"	26.5"
Overall Height	40"	42.5"
Seat Width	19.5"	19.5"
Seat Depth	19.5"	19.5"
Seat Height	23"–31"	25.5"–35.5"
Back Width	20.5"	20.5"
Back Height	16"	16"
Materials		
COM	1.75 yd 1.3 yd (BN)	1.75 yd 1.3 yd (BN)
COL	30 sq ft 22 sq ft (BN)	30 sq ft 22 sq ft (BN)
Weight and Capacity		
Weight Armless	55 lb	55 lb
Weight With Arms	68 lb	68 lb
Weight Capacity Warranty	350 lb	350 lb

Ballistic nylon back (BN).

Novo

MESH BACK TASK CHAIR

*Hyper-customizable.
Super-ergonomic.*

Since its launch in 2016, our Novo™ task chair has been recognized for its designer-friendly features and superior ergonomics. With comfort-first design that's also customizable down to the last detail (we offer 13 choices for lumbar accent colors alone!), personalizing is easy—whether you need something professional for the boardroom or vibrant for a modern, collaborative space.



Best
Featured with Electric Blue mesh
and SitOnIt Seating's Dash Dove



EFFECTIVE NOVEMBER 4, 2024

Featured Models

GOOD :: \$726

Midback mesh with adjustable lumbar, black frame, swivel-tilt mechanism, height-adjustable arms, black nylon base, grade 1 textile

BETTER :: \$776

Highback mesh with adjustable lumbar, black frame, standard synchro mechanism, height-adjustable arms, black nylon base, grade 1 textile

BEST :: \$935

Highback mesh with adjustable lumbar, fog frame, standard synchro mechanism with seat-depth adjustment, multi-adjustable arms, fog nylon base, grade 1 textile

- Midback and highback task chairs
- Adjustable lumbar support comes standard on all models
- Three frame colors with matching base
- Three lumbar colors with 13 lumbar accent colors
- 12 mesh colors
- Basic, standard synchro and swivel-tilt mechanisms
- Three arm types: fixed, height-adjustable or multi-adjustable (height/width)
- Textured, easy-grip arms
- Adjustable seat depth (optional)
- Polished aluminum base (optional)
- Waterfall seat
- Standard 300 lb weight capacity warranty;
Super Duty Series 400 lb weight capacity warranty

1. Back

Back Size and Style	Code	Price	
Midback Mesh With Adjustable Lumbar Support	1033 BK1	\$741	

Highback Mesh With Adjustable Lumbar Support	1033 BK2	\$776	
--	----------	-------	---

Adjustable Lumbar Color	Code	Price	
Black	AL1	+ \$0	
White	AL2	+ \$0	
Fog	AL3	+ \$0	

MESH BACK TASK CHAIR

1. Back (Cont.)

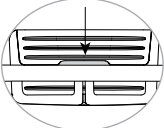

Lumbar Accent Color	Code	Price	
Apple	LA12	+ \$0	
Aqua	LA11	+ \$0	
Desert	LA3	+ \$0	
Electric Blue	LA5	+ \$0	
Fire	LA6	+ \$0	
Fog	LA4	+ \$0	
Grape	LA7	+ \$0	
Lemon	LA8	+ \$0	
Nickel	LA2	+ \$0	
Ocean	LA10	+ \$0	
Onyx	LA1	+ \$0	
Tangerine	LA9	+ \$0	
White	LA13	+ \$0	

2. Super Duty

Super Duty Series	Code	Price	
Large and Tall (Black Highback Frame With Enhanced Synchro Y Mechanism and Sport Height-Adjustable Arms)	LT	+ \$400	

See the Super Duty Guide on page 626 for additional options Heavy Duty and Large and Tall options.

3. Mechanism

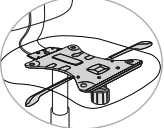
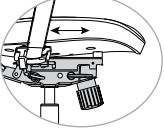
Mechanism Style	Code	Price	
Basic (Swivel Only)	B	- \$30	
Swivel-Tilt	T	- \$15	
Standard Synchro	F	+ \$0	
Standard Synchro With Seat-Depth Adjustment	F E3	+ \$79	

Seat-depth adjustment (F E3) not available on lower cylinder (CH4).

4. Frame

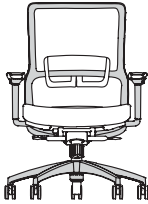
Frame Color	Code	Price	
Black	FC1	+ \$0	
White	FC12	+ \$45	
Fog	FC13	+ \$45	

5. Arms

Arm Style	Code	Price	
Armless	AR0	- \$45	
Fixed Task	AR2	- \$10	
Height-Adjustable	AR4	+ \$0	
Multi-Adjustable (Height/Width)	AR6	+ \$35	

MESH BACK TASK CHAIR

6. Base

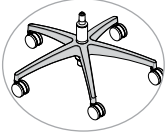
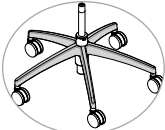
Base Color and Material	Code	Price	
Black Nylon Base (For Black Frame FC1)	B17	+ \$0	
White Nylon Base (For White Frame FC12)	B20	+ \$0	
Fog Nylon Base (For Fog Frame FC13)	B21	+ \$0	
Polished Aluminum Base	B18	+ \$119	

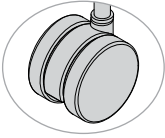
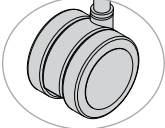
Casters or Glides	Code	Price	
Casters			
Carpet Casters	CS5	+ \$0	
Hard Floor and Carpet Casters	CS6	+ \$45	

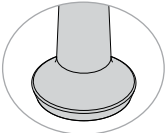
Glides			
Glides for Task Chairs	CS3	+ \$35	

Cylinder Height	Code	Price	
Standard Cylinder	CH1	+ \$0	
Higher Cylinder	CH3	+ \$0	
Lower Cylinder	CH4	+ \$0	

Nylon bases must match frame color. The polished aluminum base (B18) can be ordered with any frame color.

Higher cylinder (CH3) and lower cylinder (CH4) options are only available with the black nylon base (B17). Style of nylon base will change with higher or lower cylinder.

7. Material

Protection	Code	Price
Fire Retardancy		
CAL 133, Fabric, Quantities 1–49	133F	+ \$99
CAL 133, Fabric, Quantities 50+	133F5	+ \$55
CAL 133, Leather, Any Quantity	133L	+ \$119
Mesh Color	Code	Price
Apple	MC31	+ \$0
Aqua	MC30	+ \$0
Desert	MC22	+ \$0
Electric Blue	MC24	+ \$0
Fire	MC25	+ \$0
Fog	MC23	+ \$0
Grape	MC26	+ \$0
Lemon	MC27	+ \$0
Nickel	MC21	+ \$0
Ocean	MC29	+ \$0
Onyx	MC20	+ \$0
Tangerine	MC28	+ \$0
Seat Textile	Code	Price
Fabric/Vinyl Grade 1	FG1/VG1	+ \$0
COM	COM	+ \$30
Fabric/Vinyl Grade 2	FG2/VG2	+ \$30
Fabric/Vinyl Grade 3	FG3/VG3	+ \$60
Fabric/Vinyl Grade 4	FG4/VG4	+ \$116
Fabric/Vinyl Grade 5	FG5/VG5	+ \$172
Fabric/Vinyl Grade 6	FG6/VG6	+ \$213
Fabric/Vinyl Grade 7	FG7/VG7	+ \$254
Leather Grade 1	LG1	+ \$300
COL	COL	+ \$380
Leather Grade 2	LG2	+ \$380
Leather Grade 3	LG3	+ \$480

Please reference the [Textile Reference Guide](#) for pricing on fabric over grade 7 and leather over grade 3. Additional CAL 133 information can be found on [page 15](#).

MESH BACK TASK CHAIR

8. Packaging

Packaging	Code	Price
Knocked Down	KD	+ \$0
Back Attached to Seat, Base Separate	UC	+ \$80
Fully Assembled in a Carton	AC	+ \$200



Good
Featured with Ocean mesh
SitOnIt Seating's Sugar – Navy

SPECIFICATIONS

	1033.BK1 Midback Task Chair	1033.BK2 Highback Task Chair
Dimensions		
Overall Width Armless	26"	26"
Overall Width With Arms	26"	26"
Overall Depth	26"	26"
Overall Height	36"	39"
Seat Width	20"	20"
Seat Depth	16.5"-18.5"	16.5"-18.5"
Seat Height	16"-19.75" (B) 16.25"-20" (T) 16.75"-20.25" (F) 17"-20.625" (F/E3)	16"-19.75" (B) 16.25"-20" (T) 16.75"-20.25" (F) 17"-20.625" (F/E3)
Seat Height With Higher Cylinder	16.25"-21.25" (B) 16.5"-21.5" (T) 17"-22" (F) 17.25"-22.25" (F/E3)	16.25"-21.25" (B) 16.5"-21.5" (T) 17"-22" (F) 17.25"-22.25" (F/E3)
Seat Height With Lower Cylinder	14.5"-18.25" (B) 14.75"-17.5" (T) 15.25"-18" (F) 15.5"-18.25" (F/E3)	14.5"-18.25" (B) 14.75"-17.5" (T) 15.25"-18" (F) 15.5"-18.25" (F/E3)
Back Width	19"	19"
Back Height	20"	23"
Materials		
COM	1 yd	1 yd
COL	17 sq ft	17 sq ft
Weight and Capacity		
Weight Armless	31 lb	32 lb
Weight With Arms	37 lb	38 lb
Weight Capacity Warranty	300 lb	300 lb

Basic mechanism (B). Swivel-tilt mechanism (T). Standard synchro mechanism (F).
Seat-depth adjustment (E3). Enhanced synchro mechanism (Y).

MESH BACK TASK CHAIR

SPECIFICATIONS

	1033.BK2 LT Large and Tall Task Chair
Dimensions	
Overall Width Armless	26"
Overall Width With Arms	29"
Overall Depth	29"
Overall Height	39"
Seat Width	22"
Seat Depth	17.5"-19.5"
Seat Height	16.75"-19.75" (Y)
Seat Height With Higher Cylinder	20.5"-25"
Back Width	19"
Back Height	21.5"
Materials	
COM	1.15 yd
COL	18 sq ft
Weight and Capacity	
Weight Armless	46 lb
Weight With Arms	52 lb
Weight Capacity Warranty	400 lb

Enhanced synchro mechanism (Y).

Novo

MESH BACK TASK STOOL

*Hyper-customizable.
Super-ergonomic.*

Since its launch in 2016, our Novo™ collection has been recognized for its designer-friendly features and superior ergonomics. With comfort-first design that's also customizable down to the last detail (we offer 13 choices for lumbar accent colors alone!), personalizing is easy—whether you need something professional for the boardroom or vibrant for a modern, collaborative space.



reddot design award
winner 2017



Best
Featured with Ocean mesh and
SitOnIt Seating's Dash — Dove

EFFECTIVE NOVEMBER 4, 2024

Featured Models

GOOD :: \$806

Midback mesh with adjustable lumbar, basic mechanism, black frame, armless, black nylon base, carpet casters, grade 1 textile

BETTER :: \$851

Midback mesh with adjustable lumbar, basic mechanism, black frame, height-adjustable arms, black nylon base, carpet casters, grade 1 textile

BEST :: \$931

Midback mesh with adjustable lumbar, basic mechanism, white frame, multi-adjustable arms, white nylon base, carpet casters, grade 1 textile

Features

- Midback task stool
- Adjustable lumbar support comes standard on all models
- Three frame colors with matching base
- Three lumbar colors with 13 lumbar accent colors
- 12 mesh colors
- Basic mechanism
- Three arm types: fixed, height-adjustable or multi-adjustable (height/width)
- Textured, easy-grip arms
- Polished aluminum base (optional)
- Waterfall seat
- Standard 300 lb weight capacity

1. Back

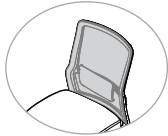
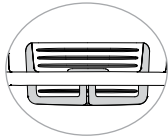
Back Size and Style	Code	Price	
Midback Mesh Task Stool With Adjustable Lumbar Support	1033 BK1	\$851	
Adjustable Lumbar Color	Code	Price	
Black	AL1	+ \$0	
White	AL2	+ \$0	
Fog	AL3	+ \$0	

MESH BACK TASK STOOL

1. Back (Cont.)

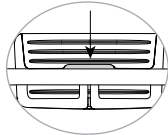
Lumbar Accent Color	Code	Price	
Apple	LA12	+ \$0	
Aqua	LA11	+ \$0	
Desert	LA3	+ \$0	
Electric Blue	LA5	+ \$0	
Fire	LA6	+ \$0	
Fog	LA4	+ \$0	
Grape	LA7	+ \$0	
Lemon	LA8	+ \$0	
Nickel	LA2	+ \$0	
Ocean	LA10	+ \$0	
Onyx	LA1	+ \$0	
Tangerine	LA9	+ \$0	
White	LA13	+ \$0	

2. Mechanism

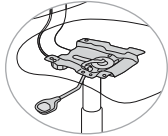
Mechanism Style	Code	Price	
Basic (Swivel Only)	B	+ \$0	



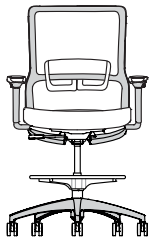

3. Frame

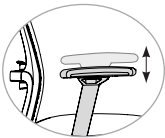
Frame Color	Code	Price	
Black	FC1	+ \$0	
White	FC12	+ \$45	
Fog	FC13	+ \$45	

4. Arms

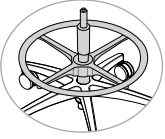
Arm Style	Code	Price	
Armless	AR0	- \$45	
Fixed Task	AR2	- \$10	
Height-Adjustable	AR4	+ \$0	
Multi-Adjustable (Height/Width)	AR6	+ \$35	

5. Base

Base	Code	Price	
Stool Kit	S1	+ \$0	
Extended Stool Kit	S2	+ \$24	
Base Color and Material	Code	Price	
Black Nylon Base (For Black Frame FC1)	B17	+ \$0	
White Nylon Base (For White Frame FC12)	B20	+ \$0	
Fog Nylon Base (For Fog Frame FC13)	B21	+ \$0	
Polished Aluminum Base	B18	+ \$119	

MESH BACK TASK STOOL

5. Base (Cont.)

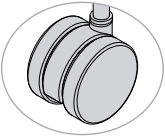
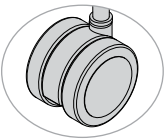
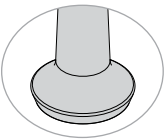
Casters or Glides	Code	Price	
Casters			
Carpet Casters	CS5	+ \$0	
Hard Floor and Carpet Casters	CS6	+ \$45	
Glides			
Glides for Task Chairs	CS3	+ \$35	

Nylon bases must match frame color. The polished aluminum base (B18) can be ordered with any frame color.

6. Material

Protection	Code	Price	
Fire Retardancy			
CAL 133, Fabric, Quantities 1-49	133F	+ \$99	
CAL 133, Fabric, Quantities 50+	133F5	+ \$55	
CAL 133, Leather, Any Quantity	133L	+ \$119	
Mesh Color	Code	Price	
Apple	MC31	+ \$0	
Aqua	MC30	+ \$0	
Desert	MC22	+ \$0	
Electric Blue	MC24	+ \$0	
Fire	MC25	+ \$0	
Fog	MC23	+ \$0	
Grape	MC26	+ \$0	
Lemon	MC27	+ \$0	
Nickel	MC21	+ \$0	
Ocean	MC29	+ \$0	
Onyx	MC20	+ \$0	
Tangerine	MC28	+ \$0	

6. Material (Cont.)

Seat Textile	Code	Price
Fabric/Vinyl Grade 1	FG1/VG1	+ \$0
COM	COM	+ \$30
Fabric/Vinyl Grade 2	FG2/VG2	+ \$30
Fabric/Vinyl Grade 3	FG3/VG3	+ \$60
Fabric/Vinyl Grade 4	FG4/VG4	+ \$116
Fabric/Vinyl Grade 5	FG5/VG5	+ \$172
Fabric/Vinyl Grade 6	FG6/VG6	+ \$213
Fabric/Vinyl Grade 7	FG7/VG7	+ \$254
Leather Grade 1	LG1	+ \$300
COL	COL	+ \$380
Leather Grade 2	LG2	+ \$380
Leather Grade 3	LG3	+ \$480

Please reference the [Textile Reference Guide](#) for pricing on fabric over grade 7 and leather over grade 3. Additional CAL 133 information can be found on [page 15](#).

MESH BACK TASK STOOL

7. Packaging

Packaging	Code	Price
Knocked Down	KD	+ \$0
Back Attached to Seat, Base Separate	UC	+ \$80
Fully Assembled in a Carton	AC	+ \$200

SPECIFICATIONS

	1033.BK1 S1 Midback Task Stool	1033.BK1 S2 Extended Task Stool
Dimensions		
Overall Width	26"	27"
Overall Depth	26"	27"
Overall Height	39"	42"
Seat Width	20"	20"
Seat Depth	16.5"	16.5"
Seat Height	21.375"-29"	24.25"-34.25"
Back Width	19"	19"
Back Height	20"	20"
Materials		
COM	1 yd	1 yd
COL	17 sq ft	17 sq ft
Weight and Capacity		
Weight Armless	29 lb	30 lb
Weight With Arms	35 lb	36 lb
Weight Capacity Warranty	300 lb	300 lb



Better
Featured with Nickel mesh and
SitOnIt Seating's Venice — Gold Dusk

OnCall

LIGHT TASK CHAIR AND TASK STOOL

*High performance,
low maintenance.*

Perfect for collaboration spaces, the lightweight OnCall™ task chair and stool feature the collection's signature built-in crescent handle and back cut-out. Mix and match with fabrics from our vast collection for the seat, back or both to create an affordable addition to creative workstations or any impromptu meeting.



EFFECTIVE NOVEMBER 4, 2024

Featured Models

GOOD :: \$435

Task chair, all plastic, swivel-tilt mechanism, armless, carpet casters

BETTER :: \$500

Task chair, upholstered seat and plastic back, swivel-tilt mechanism, armless, carpet casters, grade 1 textile



BEST :: \$623

Task chair, upholstered seat and back, swivel-tilt mechanism, fixed arms, carpet casters, grade 1 textile



Features

- Task chair and task stool
- Fully upholstered, upholstered seat or plastic
- Three plastic colors
- Built-in pull handle
- 250 lb weight capacity warranty
- Complements OnCall multipurpose chair and bar stool; see [page 271](#)

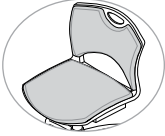
1. Back

Back and Seat Style	Code	Price	
Plastic	No Code	\$435	
Upholstered Seat Only	US	\$500	
Upholstered Seat and Back	UP	\$565	



2. Mechanism

Mechanism Style	Code	Price	
Basic (Swivel Only)	B	- \$15	
Swivel-Tilt	T	+ \$0	

Swivel-tilt (T) mechanism not available on task stool models (S1/S2).

LIGHT TASK CHAIR AND TASK STOOL

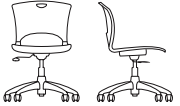
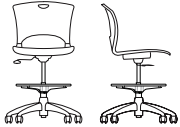
3. Frame

Frame Type	Code	Price	
Task	90T	+ \$0	
Task Stool	90TB S1	+ \$150	
Extended Task Stool	90TB S2	+ \$174	

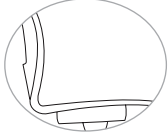
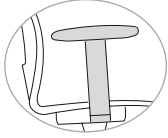

4. Arms

Arm Style	Code	Price	
Armless	A0	+ \$0	
Fixed Task	A42	+ \$58	

5. Base

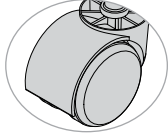
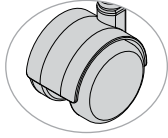
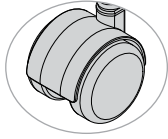
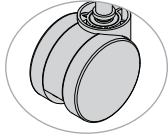
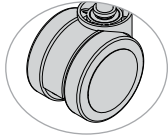
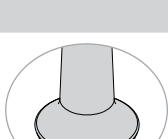
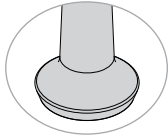
Casters or Glides	Code	Price	
Casters			
Carpet Casters	C6	+ \$0	
Hard Floor and Carpet Casters	C1	+ \$40	
Self-Locking Carpet Casters	C2	+ \$30	
Self-Locking Hard Floor and Carpet Casters	C7	+ \$61	
Heavy Duty Carpet Casters	C11	+ \$30	
Heavy Duty Hard Floor and Carpet Casters	C9	+ \$61	
Glides			
Glides for Task Chairs	C3	+ \$30	

Self-locking casters (C2/C7) lock only when not in use.

LIGHT TASK CHAIR AND TASK STOOL

6. Material

Protection	Code	Price	
Fire Retardancy			
CAL 133, Fabric, Quantities 1-49	133F	+ \$99	
CAL 133, Fabric, Quantities 50+	133F5	+ \$55	
CAL 133, Plastic, Any Quantity	133P	+ \$45	
Shell Color	Code	Price	
Black	SC1	+ \$0	
Navy	SC5	+ \$0	
Slate	SC8	+ \$0	
Textile	Code	Price	
Seat Textile Only (For US)			
Fabric/Vinyl Grade 1	FG1/VG1	+ \$0	
COM	COM	+ \$24	
Fabric/Vinyl Grade 2	FG2/VG2	+ \$24	
Fabric/Vinyl Grade 3	FG3/VG3	+ \$45	
Fabric/Vinyl Grade 4	FG4/VG4	+ \$77	
Fabric/Vinyl Grade 5	FG5/VG5	+ \$116	
Fabric/Vinyl Grade 6	FG6/VG6	+ \$159	
Fabric/Vinyl Grade 7	FG7/VG7	+ \$200	
Seat and Back Textile (For UP)			
Fabric/Vinyl Grade 1	FG1/VG1	+ \$0	
COM	COM	+ \$36	
Fabric/Vinyl Grade 2	FG2/VG2	+ \$36	
Fabric/Vinyl Grade 3	FG3/VG3	+ \$74	
Fabric/Vinyl Grade 4	FG4/VG4	+ \$121	
Fabric/Vinyl Grade 5	FG5/VG5	+ \$174	
Fabric/Vinyl Grade 6	FG6/VG6	+ \$235	
Fabric/Vinyl Grade 7	FG7/VG7	+ \$296	

Please reference the [Textile Reference Guide](#) for pricing on fabric over grade 7. Additional CAL 133 information can be found on [page 15](#).

7. Packaging

Packaging	Code	Price	
Back Attached to Seat, Base Separate	UC	+ \$0	
Fully Assembled in a Carton	AC	+ \$120	

SPECIFICATIONS

	90T Task Chair	90T S1 Task Stool	90T S2 Extended Task Stool
Dimensions			
Overall Width	26"	26"	26"
Overall Depth	26.5"	26"	26"
Overall Height	34"	37.5"	41.5"
Seat Width	18"	18"	18"
Seat Depth	17.5"	17.5"	17.5"
Seat Height	16.5"-20.5"	20"-28"	24"-34"
Back Width	19"	19"	19"
Back Height	15"	15"	15"
Materials			
COM	0.8 (US) 0.85 (UP)	0.8 (US) 0.85 (UP)	0.8 (US) 0.85 (UP)
Weight and Capacity			
Weight Armless	26.2 lb	25.5 lb	25.5 lb
Weight With Arms	32.2 lb	29 lb	29 lb
Weight Capacity Warranty	250 lb	250 lb	250 lb



Best
Featured with a slate shell and
SitOnIt Seating's Spice – Fire

Orbix

LIGHT TASK CHAIR AND STOOL

Everything you need (and more).

More design. More comfort. More models to match the needs of any space. The robust build of Orbix features an ultra-supportive and extra-wide backrest with hundreds of diamond-cut perforations for unmatched breathability and comfort.



*Upholstered
Featured with a Slate shell and
SitOnIt Seating's Dash — Cloud*

EFFECTIVE NOVEMBER 4, 2024

Featured Models

PLASTIC :: \$374

Light task chair, plastic seat and back, carpet casters

UPHOLSTERED :: \$439

Light task chair, upholstered seat, plastic back, carpet casters, grade 1 textile



STOOL :: \$613

Extended light task stool, upholstered seat, plastic back, carpet casters, grade 1 textile

Features

- Consistent, cohesive look with a broad statement of line offers options to fit any space
- Upscale style with bold lines and striking detail
- Ultra-supportive, extra-wide backrest provides lasting comfort
- Hundreds of diamond-cut perforations offer unmatched breathability and visual transparency
- Integrated clean-out makes it easy to wipe down
- Collection includes wire rod, bar stool, light task and task stool; see [page 275](#) for the wire rod chair and bar stool
- 14 shell colors to coordinate with optional upholstered seat
- 300 lb weight capacity warranty

1. Frame

Frame Type	Code	Price	
Task Chair	1132 FT3 CH1	\$374	
Standard Task Stool	1132 FT3 S21	\$524	
Extended Task Stool	1132 FT3 S22	\$548	

2. Seat and Back

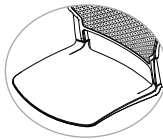
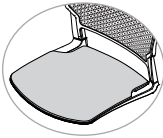
Seat Style	Code	Price	
Plastic	PS	+ \$0	
Upholstered Seat	US	+ \$65	

LIGHT TASK CHAIR AND STOOL

2. Seat and Back (Cont.)

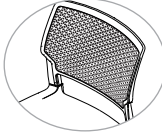
Back Style	Code	Price	
Plastic	PB	+ \$0	

3. Arms

Arm Style	Code	Price	
Armless	ARO	+ \$0	

4. Base

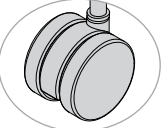
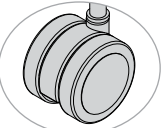
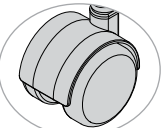
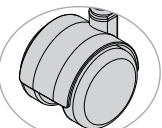
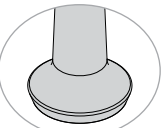
Casters or Glides	Code	Price	
Casters			
Carpet Casters	CS5	+ \$0	
Hard Floor and Carpet Casters	CS6	+ \$40	
Self-Locking Carpet Casters	C20	+ \$30	
Self-Locking Hard Floor and Carpet Casters	C19	+ \$61	
Glides			
Glides for Task Chairs	CS3	+ \$30	

Self-locking casters (C20/C19) lock only when not in use.

LIGHT TASK CHAIR AND STOOL

5. Material

Shell Color	Code	Price
Apple	SC24	+ \$0
Arctic	SC21	+ \$0
Bisque	SC7	+ \$0
Black	SC1	+ \$0
Chocolate	SC4	+ \$0
Latte	SC20	+ \$0
Lagoon	SC15	+ \$0
Lemon	SC25	+ \$0
Navy	SC5	+ \$0
Pacific	SC22	+ \$0
Red	SC19	+ \$0
Slate	SC8	+ \$0
Sterling	SC18	+ \$0
Tangerine	SC23	+ \$0

Seat Textile	Code	Price
Fabric/Vinyl Grade 1	FG1/VG1	+ \$0
COM	COM	+\$24
Fabric/Vinyl Grade 2	FG2/VG2	+\$24
Fabric/Vinyl Grade 3	FG3/VG3	+\$45
Fabric/Vinyl Grade 4	FG4/VG4	+\$77
Fabric/Vinyl Grade 5	FG5/VG5	+\$116
Fabric/Vinyl Grade 6	FG6/VG6	+\$159
Fabric/Vinyl Grade 7	FG7/VG7	+\$200

Please reference the [Textile Reference Guide](#) for pricing on fabric over grade 7 and leather over grade 3. Additional CAL 133 information can be found on [page 15](#).

6. Packaging

Packaging	Code	Price
Back Attached to Seat, Base Separate	UC	+ \$0
Fully Assembled in a Carton	AC	+ \$120

SPECIFICATIONS

	1132 FT3 CH1 Light Task Chair	1132 FT3 S21 Light Task Stool	1132 FT3 S22 Extended Task Stool
Dimensions			
Overall Width Armless	28.25"	28.25"	28.25"
Overall Depth	27.25"	27.25"	27.25"
Overall Height	32.75"-37"	36.25"-43.25"	39"-48.75"
Seat Width	18.25"	18.25"	18.25"
Seat Depth	17.25"	17.25"	17.25"
Seat Height	17.5"-22.75"	21"-28"	23.25"-33.75"
Back Width	19.75"	19.75"	19.75"
Back Height	17.5"	17.5"	17.5"
Materials			
COM	0.75 yd	0.75 yd	0.75 yd
Weight and Capacity			
Weight Armless	26 lb (PS) 27 lb (US)	3 lb (PS) 32 lb (US)	31 lb (PS) 32 lb (US)
Weight Capacity Warranty	300 lb	300 lb	300 lb

Plastic seat (PS). Upholstered seat (US).



Prava

CONFERENCE CHAIR

Command performance.

The Jorge Pensi designed Prava™ chair has double-stitched detailing and revolutionary molded-foam construction. The midback model is ideal for conference room use while the highback is well suited for any executive. A plush foam cushion in the center of the backrest offers ultimate comfort. A wide array of comfort and control options are available including three arm styles and a choice of swivel-tilt, knee-tilt or enhanced synchro adjustments. Modern and sophisticated with restrained elegance, Prava embodies the precise balance between refinement and comfort.



EFFECTIVE NOVEMBER 4, 2024

Featured Models

GOOD :: \$1,107

Midback, swivel-tilt mechanism, black fixed loop arms, black nylon base, carpet casters, grade 1 textile

BETTER :: \$1,210

Midback, knee-tilt mechanism, black 6-way arms, black nylon base, carpet casters, grade 1 textile

BEST :: \$1,381

Highback, enhanced synchro mechanism, fully adjustable black nylon arms, polished aluminum base, carpet casters, grade 1 textile

Features

- Sleek European styling
- Soft, plush foam back
- Perimeter foam for a tailored profile
- Jorge Pensi design
- Double-stitch detailing
- Aluminum accents
- Waterfall seat
- 300 lb weight capacity warranty

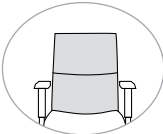
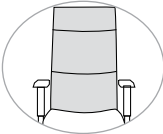
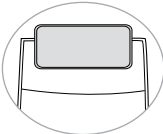

1. Back

Back Size and Style	Code	Price	
Midback	6422	\$1,140	
Highback	6423	\$1,175	
Back Options	Code	Price	
Headrest, Matches Chair Textile	HR1C0	+ \$95	



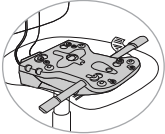
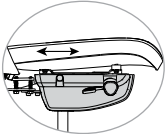

Headrest is available on highback models only.

CONFERENCE CHAIR

2. Mechanism

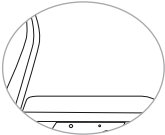
Mechanism Style	Code	Price	
Swivel-Tilt	T	- \$33	
Knee-Tilt	K	+ \$0	
Enhanced Synchro	Y	+ \$17	
Enhanced Synchro With Seat-Depth Adjustment	Y E3	+ \$96	

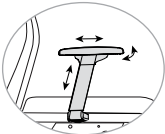
3. Arms

Arm Style	Code	Price	
Armless	A0	- \$70	
Black Fixed Loop	A111	+ \$0	
Silver Fixed Metallic Loop	A112	+ \$74	
Black Fully Adjustable (6-Way)	AR8	+ \$70	

4. Base

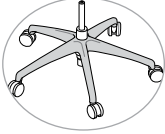
Base Color and Material	Code	Price	
Black Nylon Base	B0	+ \$0	
Silver Metallic Base	B11	+ \$119	
Polished Aluminum Base	B3	+ \$119	
Brushed Aluminum Base	B8	+ \$119	

Casters	Code	Price	
---------	------	-------	--

Carpet Casters	C16	+ \$0	
----------------	-----	-------	---

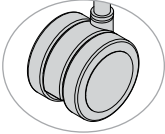
Hard Floor and Carpet Casters	C17	+ \$45	
-------------------------------	-----	--------	---

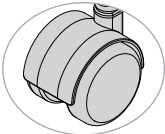
Self-Locking Carpet Casters	C20	+ \$30	
-----------------------------	-----	--------	--

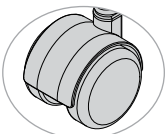
Self-Locking Hard Floor and Carpet Casters	C19	+ \$64	
--	-----	--------	---

Self-locking casters (C19/C20) lock only when not in use.

5. Material

Protection	Code	Price	
Fire Retardancy			
CAL 133, Fabric, Quantities 1-49	133F	+ \$99	
CAL 133, Fabric, Quantities 50+	133F5	+ \$55	
CAL 133, Leather, Any Quantity	133L	+ \$119	

CONFERENCE CHAIR

5. Material

Seat and Back Textile	Code	Price	
Fabric/Vinyl Grade 1	FG1/VG1	+ \$0	
COM	COM	+ \$40	
Fabric/Vinyl Grade 2	FG2/VG2	+ \$40	
Fabric/Vinyl Grade 3	FG3/VG3	+ \$78	
Fabric/Vinyl Grade 4	FG4/VG4	+ \$135	
Fabric/Vinyl Grade 5	FG5/VG5	+ \$196	
Fabric/Vinyl Grade 6	FG6/VG6	+ \$263	
Fabric/Vinyl Grade 7	FG7/VG7	+ \$332	
Leather Grade 1	LG1	+ \$340	
COL	COL	+ \$460	
Leather Grade 2	LG2	+ \$460	
Leather Grade 3	LG3	+ \$600	

Please reference the [Textile Reference Guide](#) for pricing on fabric over grade 7 and leather over grade 3. Additional CAL 133 information can be found on [page 15](#).

Please reference the [Fabric information](#) found on [page 17](#) for pricing on multi-upholstery.

6. Packaging

Packaging	Code	Price	
Knocked Down	KD	+ \$0	
Back Attached to Seat, Base Separate	UC	+ \$80	
Fully Assembled in a Carton	AC	+ \$200	

Knocked down (KD) packaging is only available on highback (6423) models with no headrest.

EFFECTIVE NOVEMBER 4, 2024 | GSA SIN #: 33721

SPECIFICATIONS

	6422 Midback	6423 Highback
Dimensions		
Overall Width Armless	19"	19"
Overall Width With Arms	26.75"	26.75"
Overall Depth	26.3"	26.3"
Overall Height	43.125"	46.125"
Seat Width	19"	19"
Seat Depth	19"	19"
Seat Height	16.75"-19.75" (T) 16.75"-20.75" (K) 16"-20" (Y)	16.75"-19.75" (T) 16.75"-20.75" (K) 16"-20" (Y)
Back Width	18.25"	18.25"
Back Height	23.75"	26.75"
Materials		
COM	2 yd	2.25 yd
COL	35 sq ft	40 sq ft
Weight and Capacity		
Weight Armless	42 lb	44 lb
Weight With Arms	50 lb	52 lb
Weight Capacity Warranty	300 lb	300 lb

Swivel-tilt mechanism (T). Knee-tilt mechanism (K). Enhanced synchro mechanism (Y).



Good
Featured with SitOnIt Seating's
Sugar – Licorice

ReAlign

TASK CHAIR

*When sleek contour
and control align.*

Contemporary tailored lines, a thin profile and enduring comfort make ReAlign™ a perfect chair for both task and conference use. The sculpted, ergonomically designed back and back-height adjustment provide lumbar support in both midback and highback styles. Seat-depth adjustment, ballistic nylon back and a Heavy Duty 24/7 option expand the versatility of this collection. With five control mechanisms and five arm styles to choose from, ReAlign can solve almost any office requirement.



Best

EFFECTIVE NOVEMBER 4, 2024

Featured Models

GOOD :: \$937

Midback, swivel-tilt mechanism, fixed arms, black nylon base, carpet casters, grade 1 textile

BETTER :: \$997

Midback, enhanced synchro mechanism, height-adjustable arms, black nylon base, carpet casters, grade 1 textile

BEST :: \$1,141

Highback, enhanced synchro mechanism, fixed loop arms, high profile polished aluminum base, carpet casters, grade 1 vinyl

Features

- Thin profile design
- Ergonomic concave/convex back
- Internal back-height adjustment (on Y & M mechanism only)
- CAL 133 approved models
- 300 lb weight capacity warranty; 350 lb Heavy Duty 24/7 weight capacity warranty

1. Back

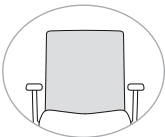
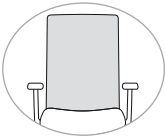
Back Size and Style	Code	Price	
Midback	681	\$997	
Highback	682	\$1,032	





2. Super Duty

Super Duty Series	Code	Price	
Heavy Duty	HD	+ \$200	

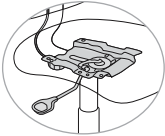

Heavy Duty option only compatible with multi-function (M), enhanced synchro (Y) and euro glide (A2) mechanisms. See the Super Duty Guide on [page 626](#) for additional LT and HD options.

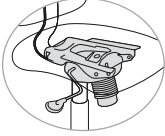
TASK CHAIR

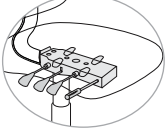
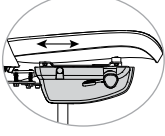
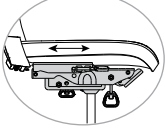
3. Mechanism

Mechanism Style	Code	Price	
Basic (Swivel Only)	B	- \$65	
Swivel-Tilt	T	- \$50	
Knee-Tilt	K	- \$17	
Enhanced Synchro	Y	+ \$0	
Multi-Function	M	+ \$36	
Enhanced Synchro With Seat-Depth Adjustment	Y E3	+ \$79	
Multi-Function With Seat-Depth Adjustment	M E3	+ \$115	

4. Arms

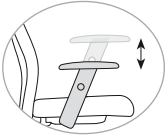
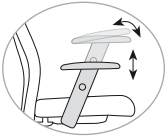
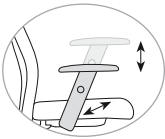
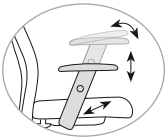
Arm Style	Code	Price	
Armless	A0	- \$80	
Fixed Loop	A77	- \$10	
Height-Adjustable	A73	+ \$0	
Height-Adjustable With Pivot	A75	+ \$10	
Height-/Width-Adjustable	A74	+ \$35	
Height-/Width-Adjustable With Pivot	A76	+ \$45	

TASK CHAIR

5. Base

Base Color and Material	Code	Price	
Black Nylon Base	B0	+ \$0	
Heavy Duty Black Nylon Base, 26" (For HD)	B7	+ \$0	
High Profile Polished Aluminum Base	B3	+ \$119	
Low Profile Base With Higher Cylinder	S8	+ \$0	

Casters or Glides	Code	Price	
Casters			

Carpet Casters	C15	+ \$0	
Hard Floor and Carpet Casters	C14	+ \$45	
Self-Locking Carpet Casters	C20	+ \$30	
Self-Locking Hard Floor and Carpet Casters	C19	+ \$64	

High profile polished aluminum base (B3) is not available with seat-depth adjustment (E3).

5. Base (Cont.)

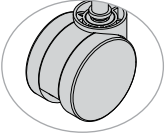
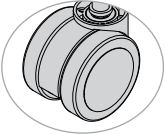
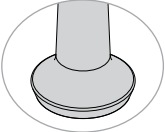
Casters or Glides	Code	Price	
Heavy Duty Casters			
Heavy Duty Carpet Casters	C11	+ \$0	
Heavy Duty Hard Floor and Carpet Casters	C9	+ \$61	
Glides			
Glides for Task Chairs	C3	+ \$35	

Higher cylinder (S8) must use enhanced synchro mechanism (Y) and is only available with low profile base and corresponding casters.

Self-locking casters (C20/C19) lock only when not in use. Heavy Duty casters must use enhanced synchro (Y) mechanism.

6. Material

Protection	Code	Price	
Fire Retardancy			
CAL 133, Fabric, Quantities 1-49	133F	+ \$99	
CAL 133, Fabric, Quantities 50+	133F5	+ \$55	
CAL 133, Leather, Any Quantity	133L	+ \$119	
Ballistic Nylon			
Ballistic Nylon Back	BN	+ \$0	

TASK CHAIR

6. Material

Seat and Back Textile	Code	Price	
Fabric/Vinyl Grade 1	FG1/VG1	+ \$0	
COM	COM	+ \$40	
Fabric/Vinyl Grade 2	FG2/VG2	+ \$40	
Fabric/Vinyl Grade 3	FG3/VG3	+ \$78	
Fabric/Vinyl Grade 4	FG4/VG4	+ \$135	
Fabric/Vinyl Grade 5	FG5/VG5	+ \$196	
Fabric/Vinyl Grade 6	FG6/VG6	+ \$263	
Fabric/Vinyl Grade 7	FG7/VG7	+ \$332	
Leather Grade 1	LG1	+ \$340	
COL	COL	+ \$460	
Leather Grade 2	LG2	+ \$460	
Leather Grade 3	LG3	+ \$600	

Please reference the [Textile Reference Guide](#) for pricing on fabric over grade 7 and leather over grade 3. Additional CAL 133 information can be found on [page 15](#).

Please reference the [Fabric information](#) found on [page 17](#) for pricing on multi-upholstery.

7. Packaging

Packaging	Code	Price	
Knocked Down	KD	+ \$0	
Back Attached to Seat, Base Separate	UC	+ \$80	
Fully Assembled In a Carton	AC	+ \$200	

EFFECTIVE NOVEMBER 4, 2024 | GSA SIN #: 33721

SPECIFICATIONS

	681 Midback Task Chair	682 Highback Task Chair
Dimensions		
Overall Width	27"	27"
Overall Depth	27"	27"
Overall Height	37.5"	40.5"
Seat Width	19"	19"
Seat Depth	19"	19"
Seat Height (Mechanism)	17"-20" (B)	17"-20" (B)
	16.625"-19.75" (T)	16.625"-19.75" (T)
	16.75"-20.25" (K)	16.75"-20.25" (K)
	16.5"-20" (I)	16.5"-20" (I)
	16.75"-20.25" (Y/M/A2)	16.75"-20.25" (Y/M/A2)
Back Width	19"	19"
Back Height	23"	26"
Materials		
COM	2 yd	2.2 yd
	1.7 yd (BN)	1.75 yd (BN)
COL	34 sq ft	40 sq ft
	30 sq ft (BN)	32 sq ft (BN)
Weight and Capacity		
Weight Armless (Mechanism)	38 lb (B)	39 lb (B)
	41 lb (T)	42 lb (T)
	49 lb (K)	50 lb (K)
	49 lb (Y/M)	50 lb (Y/M)
Weight With Arms	45 lb (B)	46 lb (B)
	48 lb (T)	49 lb (T)
	56 lb (K)	57 lb (K)
	56 lb (Y/M)	57 lb (Y/M)
Weight	300 lb	300 lb
Capacity Warranty	350 lb (HD)	350 lb (HD)

Basic mechanism (B). Swivel-tilt mechanism (T). Knee-tilt mechanism (K). Enhanced synchro mechanism (Y). Multi-function mechanism (M). Ballistic nylon back (BN). Heavy Duty (HD).

ReAlign

TASK STOOL

*When sleek contour
and control align.*

Contemporary tailored lines, a thin profile and enduring comfort make ReAlign™ a perfect stool for task use. The sculpted, ergonomically designed back and back-height adjustment provide lumbar support in both midback and highback styles. Seat-depth adjustment and ballistic nylon back expand the versatility of this collection. With five arm styles to choose from, ReAlign can solve almost any office requirement.



EFFECTIVE NOVEMBER 4, 2024

Featured Models

GOOD :: \$972

Midback stool, basic mechanism, armless, standard stool kit, black nylon base, carpet casters, grade 1 textile

BETTER :: \$1,052

Midback stool, basic mechanism, height-adjustable arms, standard stool kit, black nylon base, carpet casters, grade 1 textile

BEST :: \$1,240

Midback stool, basic mechanism, height-/width-adjustable arms with pivot, extended stool kit, high profile polished aluminum base, grade 1 textile

Features

- Thin profile design
- Ergonomic concave/convex back
- 300 lb weight capacity warranty;
350 lb Heavy Duty 24/7 weight capacity warranty

1. Back

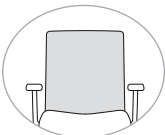
Back Size and Style	Code	Price	
Midback	681	\$1,052	

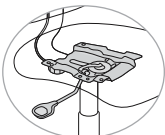

ReAlign task stool (681B) comes with basic mechanism (swivel only).

2. Mechanism



Mechanism Style	Code	Price	
Basic (Swivel Only)	B	+ \$0	

TASK STOOL

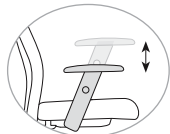
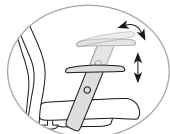
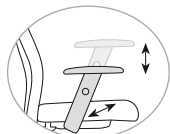
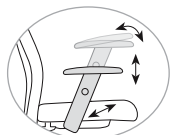
3. Arms

Arm Style	Code	Price	
Armless	A0	- \$80	
Fixed Loop	A77	- \$10	
Height-Adjustable	A73	+ \$0	
Height-Adjustable With Pivot	A75	+ \$10	
Height-/Width-Adjustable	A74	+ \$35	
Height-/Width-Adjustable With Pivot	A76	+ \$45	

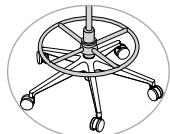
4. Base

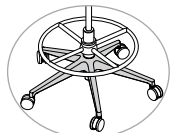
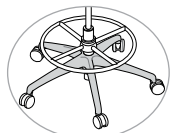
Stool Kit	Code	Price	
Standard Stool Kit	S1	+ \$0	
Extended Stool Kit	S2	+ \$24	
Base Color and Material	Code	Price	
Standard Black Nylon Base	N	+ \$0	
High Profile Polished Aluminum Base	B3	+ \$119	

4. Base (Cont.)

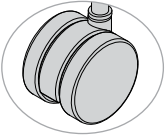
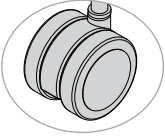
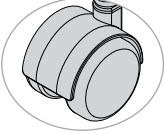
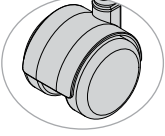
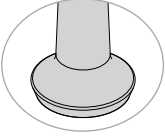
Casters or Glides	Code	Price	
Casters			
Carpet Casters	C15	+ \$0	
Hard Floor and Carpet Casters	C14	+ \$45	
Self-Locking Carpet Casters	C20	+ \$30	
Self-Locking Hard Floor and Carpet Casters	C19	+ \$64	
Glides			
Glides for Task Chairs	C3	+ \$35	

Self-locking casters (C19/C20) lock only when not in use.

5. Material

Protection	Code	Price	
Fire Retardancy			
CAL 133, Fabric, Quantities 1-49	133F	+ \$99	
CAL 133, Fabric, Quantities 50+	133F5	+ \$55	
CAL 133, Leather, Any Quantity	133L	+ \$119	
Ballistic Nylon			
Ballistic Nylon Back	BN	+ \$0	

TASK STOOL

5. Material (Cont.)

Seat and Back Textile	Code	Price	
Fabric/Vinyl Grade 1	FG1/VG1	+ \$0	
COM	COM	+ \$40	
Fabric/Vinyl Grade 2	FG2/VG2	+ \$40	
Fabric/Vinyl Grade 3	FG3/VG3	+ \$78	
Fabric/Vinyl Grade 4	FG4/VG4	+ \$135	
Fabric/Vinyl Grade 5	FG5/VG5	+ \$196	
Fabric/Vinyl Grade 6	FG6/VG6	+ \$263	
Fabric/Vinyl Grade 7	FG7/VG7	+ \$332	
Leather Grade 1	LG1	+ \$340	
COL	COL	+ \$460	
Leather Grade 2	LG2	+ \$460	
Leather Grade 3	LG3	+ \$600	

Please reference the [Textile Reference Guide](#) for pricing on fabric over grade 7 and leather over grade 3. Additional CAL 133 information can be found on [page 15](#).

Please reference the Fabric information found on [page 17](#) for pricing on multi-upholstery.

6. Packaging

Packaging	Code	Price	
Knocked Down	KD	+ \$0	
Back Attached to Seat, Base Separate	UC	+ \$80	
Fully Assembled In a Carton	AC	+ \$200	

EFFECTIVE NOVEMBER 4, 2024 | GSA SIN #: 33721

SPECIFICATIONS

	681B S1 Task Stool	681B S2 Extended Task Stool
Dimensions		
Overall Width	27"	27"
Overall Depth	27"	27"
Overall Height	41.25"-49.25"	45.25"-56.38"
Seat Width	19"	19"
Seat Depth	19"	19"
Seat Height	21.5"-29.5"	25.5"-33.5"
Back Width	19"	19"
Back Height	23"	23"
Materials		
COM	2 yd 1.7 yd (BN)	2 yd 1.7 yd (BN)
COL	34 sq ft 30 sq ft (BN)	40 sq ft 32 sq ft (BN)
Weight and Capacity		
Weight Armless	38 lb	39 lb
Weight With Arms	45 lb	46 lb
Weight Capacity Warranty	300 lb	300 lb

Ballistic nylon back (BN).



Best

Relay

LIGHT TASK CHAIR AND STOOL

Durable and adaptable to the finish.

Great to look at, Relay™ provides lasting comfort in a stylish design that makes an appealing multipurpose seating option for meeting, training, conference and break rooms. The seat and back are molded from high-impact thermoplastic for lasting durability and comfort. Select the optional upholstered seat and back for a more sophisticated, inviting look and added comfort.



Good
Featured with a Lagoon shell

EFFECTIVE NOVEMBER 4, 2024

Featured Models

GOOD :: \$569

Light task chair, plastic seat and back, basic mechanism, armless, carpet casters

BETTER :: \$649

Light task chair, upholstered seat and plastic back, swivel-tilt mechanism, armless, carpet casters, grade 1 textile



BEST :: \$772

Light task chair, upholstered seat and back, swivel-tilt mechanism, fixed cantilever arms, carpet casters, grade 1 textile

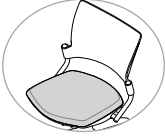

Features

- Structurally reinforced with a durable back
- High-impact polypropylene
- Fully upholstered, upholstered seat or plastic
- Nine plastic colors
- 250 lb weight capacity warranty
- Complements Relay multipurpose and nester chairs; see [page 283](#)

1. Back

Back and Seat Style	Code	Price	
Plastic	No Code	\$584	
Upholstered Seat Only	US	\$649	
Upholstered Seat and Back	UP	\$714	

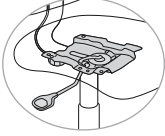

2. Mechanism

Mechanism Style	Code	Price	
Basic (Swivel Only)	B	- \$15	
Swivel-Tilt	T	+ \$0	

Swivel-tilt (T) mechanism not available with task stool (S1) or extended task stool (S2).

LIGHT TASK CHAIR AND STOOL



3. Frame

Frame Type	Code	Price	
Task Chair	94T	+ \$0	
Task Stool	94T S1	+ \$150	
Extended Task Stool	94T S2	+ \$174	



Better
Featured with a slate shell and SitOnIt Seating's Sugar — Electric Blue

4. Arms

Arm Style	Code	Price	
Armless	A0	+ \$0	
Fixed Cantilever	A60	+ \$58	

5. Base

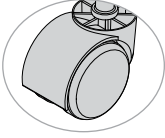
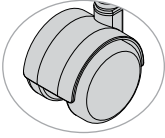
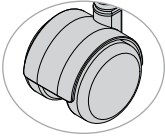
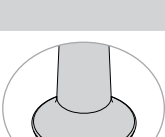
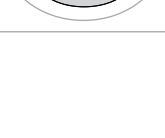
Casters or Glides	Code	Price	
Casters			
Carpet Casters	C6	+ \$0	
Hard Floor and Carpet Casters	C1	+ \$40	
Self-Locking Carpet Casters	C2	+ \$30	
Self-Locking Hard Floor and Carpet Casters	C7	+ \$61	
Glides			
Glides for Task Chairs	C3	+ \$30	

Self-locking casters lock only when not in use.

LIGHT TASK CHAIR AND STOOL

6. Material

Protection	Code	Price	
Fire Retardancy			
CAL 133, Fabric, Quantities 1-49	133F	+ \$99	
CAL 133, Fabric, Quantities 50+	133F5	+ \$55	
CAL 133, Plastic, Any Quantity	133P	+ \$45	
Shell Color	Code	Price	
Arctic	SC21	+ \$0	
Black	SC1	+ \$0	
Chocolate	SC4	+ \$0	
Lagoon	SC15	+ \$0	
Latte	SC20	+ \$0	
Navy	SC5	+ \$0	
Red	SC19	+ \$0	
Slate	SC8	+ \$0	
Sterling	SC18	+ \$0	
Textile	Code	Price	
Seat Textile (US)			
Fabric/Vinyl Grade 1	FG1/VG1	+ \$0	
COM	COM	+ \$24	
Fabric/Vinyl Grade 2	FG2/VG2	+ \$24	
Fabric/Vinyl Grade 3	FG3/VG3	+ \$45	
Fabric/Vinyl Grade 4	FG4/VG4	+ \$77	
Fabric/Vinyl Grade 5	FG5/VG5	+ \$116	
Fabric/Vinyl Grade 6	FG6/VG6	+ \$159	
Fabric/Vinyl Grade 7	FG7/VG7	+ \$200	
Seat and Back Textile (UP)			
Fabric/Vinyl Grade 1	FG1/VG1	+ \$0	
COM	COM	+ \$36	
Fabric/Vinyl Grade 2	FG2/VG2	+ \$36	
Fabric/Vinyl Grade 3	FG3/VG3	+ \$74	
Fabric/Vinyl Grade 4	FG4/VG4	+ \$121	
Fabric/Vinyl Grade 5	FG5/VG5	+ \$174	
Fabric/Vinyl Grade 6	FG6/VG6	+ \$235	
Fabric/Vinyl Grade 7	FG7/VG7	+ \$296	

Please reference the [Textile Reference Guide](#) for pricing on fabric over grade 7. Additional CAL 133 information can be found on [page 15](#).

Please reference the [Fabric information](#) found on [page 17](#) for pricing on multi-upholstery.

EFFECTIVE NOVEMBER 4, 2024 | GSA SIN #: 33721

7. Packaging

Packaging	Code	Price
Back Attached to Seat, Base Separate	UC	+ \$0
Fully Assembled In a Carton	AC	+ \$120

SPECIFICATIONS

	94T Light Task Chair	94B S1 Light Task Stool	94B S2 Extended Light Task Stool
Dimensions			
Overall Width	26"	26"	26"
Overall Depth	26"	26"	26"
Overall Height	32.25"-37.25"	35.25"	39.25"
Seat Width	18.25"	20.5"	20.5"
Seat Depth	17.25"	18"	18"
Seat Height	17"-22"	20.625"-27"	23.5"-33.50"
Back Width	19.125"	19.125"	19.125"
Back Height	17"	17"	17"
Materials			
COM	0.75 yd (US) 1 yd (UP)	0.75 yd (US) 1 yd (UP)	0.75 yd (US) 1 yd (UP)
Weight and Capacity			
Weight Armless	27 lb	31 lb	32 lb
Weight With Arms	28 lb	32 lb	33 lb
Weight Capacity	250 lb	250 lb	250 lb
Warranty			

Upholstered seat (US). Upholstered seat and back (UP).



*Best
Featured with a Navy shell and
SitOnIt Seating's Venice — Gold Dusk*

Rio

LIGHT TASK CHAIR AND STOOL

Design that responds to you.

What goes into the award-winning line of Rio® plastic chairs? Patented flexing technology, for one.

Our complete family of Rio models feature our patented Active Rebound Control (ARC) Technology®—a performance-minded flexor insert that supports a wide range of motion (20 full degrees to be exact) and responds precisely to the amount of weight pressed against it.

Add a fresh, modern color palette and you've got a seating solution that allows for more movement, day-long comfort and flexibility than any other chair in its class.



EFFECTIVE NOVEMBER 4, 2024

Featured Models

GOOD :: \$424

Light task chair, plastic seat and back, basic mechanism, armless, black frame, black base, carpet casters

BETTER :: \$489

Light task chair, upholstered seat and plastic back, basic mechanism, armless, black frame, black base, carpet casters, grade 1 textile



BEST :: \$647

Light task chair, upholstered seat and back, basic mechanism, fixed arms, silver frame, fog base, carpet casters, grade 1 textile

Features



- Exceptional support and comfort
- Fully upholstered, upholstered seat or plastic
- ARC Technology® for weight-assisted flex
- 14 plastic shell colors
- Two frame finishes with matching arm pads
- Easy-grip edge that acts as a pull handle
- Clean-out space
- 300 lb weight capacity warranty
- Complements Rio multipurpose chair, counter and bar stool; see [page 289](#)

1. Back

Back and Seat Style	Code	Price	
Plastic Seat and Back	PS	\$424	
Upholstered Seat Only	US	\$489	
Upholstered Seat and Back	UP	\$554	

LIGHT TASK CHAIR AND STOOL

2. Frame

Frame Type	Code	Price	
Task Chair	1052 FT3	+ \$0	
Task Stool	1052 FT3 S21	+ \$150	
Extended Task Stool	1052 FT3 S22	+ \$174	



Frame Finish	Code	Price	
Black	FC1	+ \$0	
Silver	FC2	+ \$35	

Rio task models available with basic (swivel) mechanism only.



Better
Featured with an Apple shell and SitOnIt Seating's Huntington — Clover

3. Arms

Arm Style	Code	Price	
Armless	A0	+ \$0	
Fixed	A91	+ \$58	

Arms, if specified, are black for black frames and fog for silver frames.

4. Base

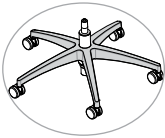
Base Color and Material	Code	Price	
Black Nylon Base (For Black Frame FC1)	B17	+ \$0	
Fog Nylon Base (For Silver Frame FC2)	B21	+ \$0	

Casters or Glides	Code	Price	
Casters			

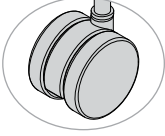
Carpet Casters	C15	+ \$0	
----------------	-----	-------	---

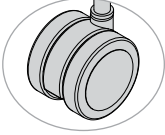
Hard Floor and Carpet Casters	C14	+ \$40	
-------------------------------	-----	--------	---

Self-Locking Carpet Casters	C20	+ \$30	
-----------------------------	-----	--------	---

Self-Locking Hard Floor and Carpet Casters	C19	+ \$64	
--	-----	--------	---

Glides

Glides for Task Chairs	C3	+ \$30	
------------------------	----	--------	---

Self-locking casters (C19/C20) lock only when chair is not in use.

LIGHT TASK CHAIR AND STOOL

5. Material

Protection	Code	Price	
Fire Retardancy			
CAL 133, Fabric, Quantities 1–49	133F	+ \$64	
CAL 133, Fabric, Quantities 50+	133F5	+ \$20	
CAL 133, Plastic, Any Quantity	133P	+ \$10	

Shell Color (For PS and US)	Code	Price	
Apple	SC24	+ \$0	
Arctic	SC21	+ \$0	
Bisque	SC7	+ \$0	
Black	SC1	+ \$0	
Chocolate	SC4	+ \$0	
Lagoon	SC15	+ \$0	
Latte	SC20	+ \$0	
Lemon	SC25	+ \$0	
Navy	SC5	+ \$0	
Pacific	SC22	+ \$0	
Red	SC19	+ \$0	
Slate	SC8	+ \$0	
Sterling	SC18	+ \$0	
Tangerine	SC23	+ \$0	

Textile	Code	Price	
Seat Textile Only (For US)			
Fabric/Vinyl Grade 1	FG1/VG1	+ \$0	
COM	COM	+ \$24	
Fabric/Vinyl Grade 2	FG2/VG2	+ \$24	
Fabric/Vinyl Grade 3	FG3/VG3	+ \$45	
Fabric/Vinyl Grade 4	FG4/VG4	+ \$77	
Fabric/Vinyl Grade 5	FG5/VG5	+ \$116	
Fabric/Vinyl Grade 6	FG6/VG6	+ \$159	
Fabric/Vinyl Grade 7	FG7/VG7	+ \$200	

Seat and Back Textile (UP)			
Fabric/Vinyl Grade 1	FG1/VG1	+ \$0	
COM	COM	+ \$36	
Fabric/Vinyl Grade 2	FG2/VG2	+ \$36	
Fabric/Vinyl Grade 3	FG3/VG3	+ \$74	
Fabric/Vinyl Grade 4	FG4/VG4	+ \$121	
Fabric/Vinyl Grade 5	FG5/VG5	+ \$174	
Fabric/Vinyl Grade 6	FG6/VG6	+ \$235	
Fabric/Vinyl Grade 7	FG7/VG7	+ \$296	

Please reference the [Textile Reference Guide](#) for pricing on fabric over grade 7. Additional CAL 133 information can be found on [page 15](#).

Please reference the [Fabric information](#) found on [page 17](#) for pricing on multi-upholstery.

EFFECTIVE NOVEMBER 4, 2024 | GSA SIN #: 33721

6. Packaging

Packaging	Code	Price
Back Attached to Seat, Base Separate	UC	+ \$0
Fully Assembled in a Carton	AC	+ \$120

SPECIFICATIONS

	1052 Light Task Chair	1052 S21 Light Task Stool	1052 S22 Extended Light Task Stool
Dimensions			
Overall Width	27"	27"	27"
Overall Depth	27"	27"	27"
Overall Height	31.9"-36.9"	37.9"-45.9"	41.9"-51.9"
Seat Width	18.5"	18.5"	18.5"
Seat Depth	18.2"	18.2"	18.2"
Seat Height	16.62"-21.75"	18"-26"	23"-33"
Back Width	17.5"	17.5"	17.5"
Back Height	18.2"	18.2"	18.2"
Materials			
COM	0.85 yd (US) 1 yd (UP)	0.85 yd (US) 1 yd (UP)	0.85 yd (US) 1 yd (UP)
Weight and Capacity			
Weight Armless	20.5 lb	25.1 lb	26 lb
Weight With Arms	22.2 lb	26.8 lb	27.7 lb
Weight Capacity Warranty	300 lb	300 lb	300 lb

Upholstered seat (US). Upholstered seat and back (UP).



*Best
Featured with a Sterling shell and
SitOnIt Seating's Venice — Gold Dusk*

Stephen

CONFERENCE CHAIR

*Classic comfort.
Modern design.*

Discover a collection made to lift up the notion of timeless aesthetics. This award-winning design from world-renowned designer Claudio Bellini elevates your everyday conference chair with a balanced touch of plush comfort and refined style that'll always feel on-trend.

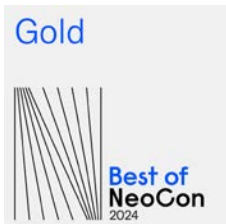

Executive Back
Featured with SitOnIt Seating's Rally – Thunder

EFFECTIVE NOVEMBER 4, 2024

Featured Models

LOWBACK :: \$1,294

Lowback conference chair with no arms, a swivel tilt mechanism, standard cylinder, 5-star metal base, carpet casters, and grade 1 fabric

HIGHBACK :: \$1,406

Highback conference chair with fixed charcoal aluminum fixed arms, a swivel-tilt mechanism, standard cylinder, 5-star metal base, carpet casters, and grade 1 vinyl



EXECUTIVE BACK :: \$2,125

Executive back conference chair with polished aluminum fixed arms, a knee-tilt mechanism with polished aluminum accents, standard cylinder, 5-star polished aluminum base, hard floor and carpet casters with polished accents, and grade 1 leather

Features

- Best of NeoCon Gold winner from Claudio Bellini
- Balanced comfort and refined style that'll always feels on-trend
- Slim silhouette and alluring curves look good from every angle
- Distinctive wraparound arms with polished accents
- Tailored stitching highlights plush comfort
- A family of luxury featuring low-, high- and executive-back models
- Lifetime warranty designed to exceed BIFMA x5.1-2017 durability standard
- 350 lb weight capacity warranty

1. Back

Back Size and Style	Code	Price	
Lowback	1664 BK3	\$1,374	
Highback	1664 BK2	\$1406	
Executive Back	1664 BK5	\$1,438	

2. Mechanism

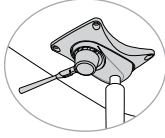
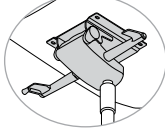
Mechanism Style	Code	Price	
Swivel-Tilt	T	+ \$0	
Swivel-Tilt With Polished Aluminum Accents	TC	+ \$45	
Knee-Tilt	K	+ \$33	
Knee-Tilt With Polished Aluminum Accents	KC	+ \$78	

CONFERENCE CHAIR

4. Arms

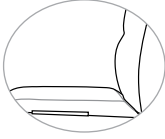
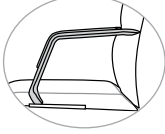
Arm Style	Code	Price	
Armless	AR0	- \$80	
Charcoal Aluminum Fixed Arms	AR21	+ \$0	
Polished Aluminum Fixed Arms	AR22	+ \$75	

5. Base

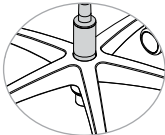
Cylinder Height	Code	Price	
Standard Cylinder	CH1	+ \$0	
Fixed Height Free-Swivel Cylinder	CH5	+ \$0	

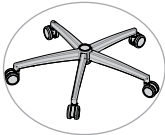
Base Material	Code	Price	
5-Star Metal	BT7	+ \$0	
5-Star Polished Aluminum	BT2	+ \$119	

Base Color	Code	Price	
Charcoal	BC5	+ \$0	

Casters or Glides	Code	Price	
-------------------	------	-------	--

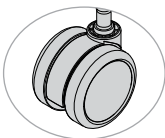
Casters			
Carpet Casters	CS5	+ \$0	
Hard Floor and Carpet Casters	CS6	+ \$45	
Hard Floor and Carpet Casters With Polished Accents	CS6C	+ \$75	

Glides			
--------	--	--	--

Glides for Task Chairs	CS20	+ \$35	
------------------------	------	--------	---

6. Material

Seat Textile	Code	Price		
		Lowback	Highback	Executive Back
Fabric/Vinyl Grade 1	FG1/VG1	+ \$0	+ \$0	+ \$0
COM	COM	+ \$29	+ \$32	+ \$36
Fabric/Vinyl Grade 2	FG2/VG2	+ \$29	+ \$32	+ \$36
Fabric/Vinyl Grade 3	FG3/VG3	+ \$63	+ \$70	+ \$78
Fabric/Vinyl Grade 4	FG4/VG4	+ \$109	+ \$122	+ \$135
Fabric/Vinyl Grade 5	FG5/VG5	+ \$159	+ \$176	+ \$196
Fabric/Vinyl Grade 6	FG6/VG6	+ \$213	+ \$237	+ \$263
Fabric/Vinyl Grade 7	FG7/VG7	+ \$269	+ \$299	+ \$332
Leather Grade 1	LG1	+ 275	+ \$306	+ \$340
COL	COL	+ \$373	+ \$414	+ \$460
Leather Grade 2	LG2	+ \$373	+ \$414	+ \$460
Leather Grade 3	LG3	+ \$486	+ \$540	+ \$600

Please reference the [Textile Reference Guide](#) for pricing on fabric over grade 7 and leather over grade 3.



Lowback

Featured with SitOnIt Seating's Dash – Dove

CONFERENCE CHAIR

7. Packaging

Packaging	Code	Price
Back Attached to Seat, Base Separate	UC	+ \$0
Fully Assembled in a Bag (Southern CA Only)	AB	+ \$0
Fully Assembled in a Carton	AC	+ \$120

SPECIFICATIONS

	Lowback	Highback	Executive Back
Dimensions			
Overall Width	27"	27"	27"
Overall Depth	27"	27"	27"
Overall Height	39.5"	46.25"	49"
Seat Width	20"	20"	20"
Seat Depth	17.5"	17.5"	17.5"
Seat Height	17.5"-21" (T, CH1) 18.25"-21.25" (K, CH1) 18.875" (CH5)	17.5"-21" (T, CH1) 18.25"-21.25" (K, CH1) 18.875" (CH5)	17.5"-21" (T, CH1) 18.25"-21.25" (K, CH1) 18.875" (CH5)
Back Width	19"	19"	19"
Back Height	18.75"	25.75"	28"
Materials			
COM	1.75 yd	2 yd	2.25 yd
COL	32 sq ft	35 sq ft	40 sq ft
Weight and Capacity			
Weight Armless	32"	38"	40"
Weight With Arms	40"	46"	48"
Weight Capacity Warranty	350 lb	350 lb	350 lb

Standard cylinder (CH1). Fixed height free-swivel cylinder (CH5). Swivel-tilt mechanism (T). Knee-tilt mechanism (K).

Sona

CONFERENCE CHAIR

Meet in harmony.

Create contemporary conference rooms with the distinct style of Sona™. This up-to-any-task chair surrounds your tables with smart, sleek and slim lines while powering productivity with essential ergonomic engineering.



EFFECTIVE NOVEMBER 4, 2024

Featured Models

GOOD :: \$1,152

Knit back, swivel-tilt mechanism, open loop black arms, black nylon base, carpet casters, grade 1 textile

BETTER :: \$1,195

Knit back, knee-tilt mechanism, fully adjustable black arms (6-way), black nylon base, carpet casters, grade 1 textile

BEST :: \$1,377



Upholstered back, enhanced synchro mechanism, open loop silver metallic arms, silver metallic base, silver metallic pull handle, carpet casters, grade 1 textile

Features

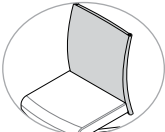

- Settle in with lumbar curve and height-adjustable back
- Add style and texture with 11 airy knit meshes
- 300 lb weight capacity warranty

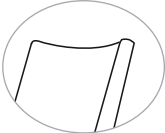
1. Back

Back Size and Style	Code	Price	
Knit Back	5723 B7	\$1,195	
Upholstered Back	5723 B8	\$1,195	

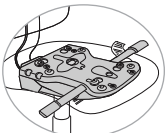

Back Options	Code	Price	
No Pull Handle	PH0	+ \$0	
Black Nylon Pull Handle	PH1	+ \$26	
Silver Metallic Pull Handle	PH2	+ \$32	

2. Mechanism

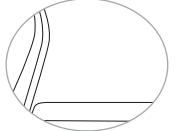

Mechanism	Code	Price	
Swivel-Tilt	T	- \$33	
Knee-Tilt	K	+ \$0	
Enhanced Synchro	Y	+ \$17	
Enhanced Synchro With Seat-Depth Adjustment	Y E3	+ \$96	

CONFERENCE CHAIR

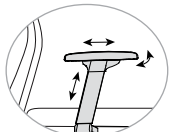
3. Arms

Arm Style	Code	Price	
Armless	A0	- \$80	
Black Fixed Loop	A111	- \$10	
Silver Fixed Metallic Loop	A112	+ \$14	
Fully Adjustable Black (6-Way)	AR8	+ \$0	

4. Base

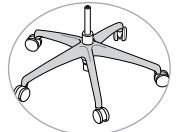
Base Color and Material	Code	Price	
Black Nylon Base	B0	+ \$0	
Silver Metallic Base	B10	+ \$119	
Polished Aluminum Base	B3	+ \$119	
Brushed Aluminum Base	B25	+ \$119	
Low Profile Base With Higher Cylinder	S8	+ \$0	

High cylinder with low profile base (S8) is available with enhanced synchro (Y) mechanism only.

4. Base (Cont.)

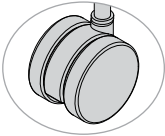
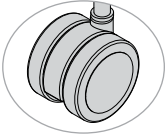
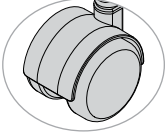
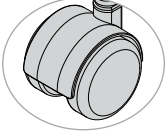
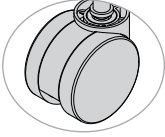
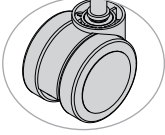
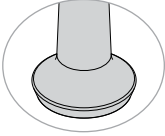
Casters or Glides	Code	Price	
Casters			
Carpet Casters	C16	+ \$0	
Hard Floor and Carpet Casters	C17	+ \$45	
Self-Locking Carpet Casters	C20	+ \$30	
Self-Locking Hard Floor and Carpet Casters	C19	+ \$64	
Casters for Low Profile Base With Higher Cylinder (S8)			
Carpet Casters	C21	+ \$0	
Hard Floor and Carpet Casters	C22	+ \$45	
Glides			
Glides for Task Chairs	C3	+ \$35	

Self-locking casters (C19/C20) lock only when chair is not in use.

5. Material

Protection	Code	Price	
Fire Retardancy			
CAL 133, Fabric, Quantities 1-49	133F	+ \$99	
CAL 133, Fabric, Quantities 50+	133F5	+ \$55	
CAL 133, Leather, Any Quantity	133L	+ \$119	

CONFERENCE CHAIR

5. Material (Cont.)

Knit Color	Code	Price	
Textured Knit			
Black	KP10	+ \$0	
Cool Gray	KP11	+ \$0	
Dune	KP13	+ \$0	
Forest	KP14	+ \$0	
Merlot	KP16	+ \$0	
Mocha	KP12	+ \$0	
Ocean	KP15	+ \$0	
Twin Knit			
Licorice	KP23	+ \$0	
Shadow	KP22	+ \$0	
Toffee	KP20	+ \$0	
Winter Gray	KP21	+ \$0	



Better
Featured with a Cool Gray knit back and SitOnIt Seating's Venice — Gold Dusk

5. Material (Cont.)

Textile (For Both B7 and B8)	Code	Price
Fabric/Vinyl Grade 1	FG1/VG1	+ \$0
COM	COM	+ \$40
Fabric/Vinyl Grade 2	FG2/VG2	+ \$40
Fabric/Vinyl Grade 3	FG3/VG3	+ \$74
Fabric/Vinyl Grade 4	FG4/VG4	+ \$121
Fabric/Vinyl Grade 5	FG5/VG5	+ \$174
Fabric/Vinyl Grade 6	FG6/VG6	+ \$235
Fabric/Vinyl Grade 7	FG7/VG7	+ \$296
Leather Grade 1	LG1	+ \$320
COL	COL	+ \$420
Leather Grade 2	LG2	+ \$420
Leather Grade 3	LG3	+ \$540

Please reference the [Textile Reference Guide](#) for pricing on fabric over grade 7 and leather over grade 3. Additional CAL 133 information can be found on [page 15](#).

Please reference the [Fabric information](#) found on [page 17](#) for pricing on multi-upholstery.



Good

Featured with a Winter Gray knit back and SitOnIt Seating's Huntington – Tropical

CONFERENCE CHAIR

6. Packaging

Packaging	Code	Price
Knocked Down	KD	+ \$0
Back Attached to Seat, Base Separate	UC	+ \$80
Fully Assembled in a Carton	AC	+ \$200

SPECIFICATIONS

5723 Conference Chair	
Dimensions	
Overall Width	27"
Overall Depth	25"
Overall Height	37"-43.5"
Seat Width	19"
Seat Depth	18"
Seat Height	17.5"-20.5"
Back Width	19"
Back Height	25"
Materials	
COM	1 yd (B7) 1.75 yd (B8)
COL	17 sq ft (B7) 32 sq ft (B8)
Weight and Capacity	
Weight Armless	46 lb
Weight With Arms	52 lb
Weight Capacity Warranty	300 lb

Knit back (B7). Upholstered back (B8).

Torsa

TASK CHAIR

Inspired by nature.

Cutting-edge design and the ability to personalize frame, arm, and mesh color combinations make Torsa™ the natural preference for a fresh, clean style. The innovative cable-driven synchro mechanism with Comfort Drive® allows easy fingertip adjustment from a seated position. And remarkably, excellent ergonomics come standard with adjustable lumbar support and seat-depth adjustment.



Best
Featured with Fog Striped mesh
and SitOnIt Seating's Dash —Midnight

EFFECTIVE NOVEMBER 4, 2024

Featured Models

GOOD :: \$990

Enhanced synchro mechanism with Comfort Drive and seat-depth adjustment, fixed nylon arms, nylon base, carpet casters, grade 1 textile

BETTER :: \$1,035

Enhanced synchro mechanism with Comfort Drive and seat-depth adjustment, multi-adjustable nylon arms, nylon base, carpet casters, grade 1 textile

BEST :: \$1,229

Enhanced synchro mechanism with Comfort Drive and seat-depth adjustment, fixed polished aluminum arms, polished aluminum base, carpet casters, grade 1 textile

Features

- Cutting-edge design
- Comfortable and durable mesh back
- 10 bleach-cleanable mesh colors
- Four frame/arm/back support color combinations
- Enhanced synchro with Comfort Drive and seat-depth adjustment
- Adjustable lumbar support
- Textured control knobs
- Waterfall seat

1. Back

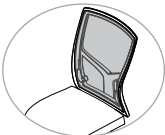
Back Size and Style	Code	Price	
Highback Mesh	6023	\$1,035	

2. Mechanism

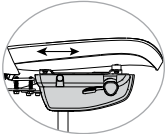
Mechanism Style	Code	Price	
Enhanced Synchro With Comfort Drive and Seat-Depth Adjustment	Y E3	+ \$0	

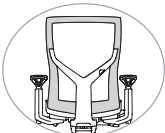
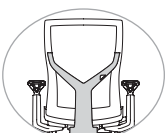

Seat-depth adjustment available with enhanced synchro (Y) mechanism only.

3. Frame

Frame Color	Code	Price	
Graphite	FC11	+ \$0	
White	FC12	+ \$0	
Back Support Color	Code	Price	
Graphite	Z3	+ \$0	
White	Z4	+ \$0	

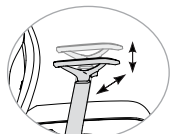

TASK CHAIR

4. Arms

Arm Style	Code	Price	
Armless	A0	- \$80	
Fixed Nylon	A132	- \$45	
Fixed Polished Aluminum	A131	+ \$75	
Multi-Adjustable (Height/Width)	A134	+ \$0	

Arm color will match back support color. Fixed polished aluminum arms available with either back support color.

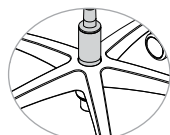
5. Base

Cylinder Height	Code	Price	
Standard Cylinder	No Code	+ \$0	
Higher Cylinder	S13	+ \$0	
Base Color and Material	Code	Price	
Graphite Nylon Base (For Graphite Frame C11)	B14	+ \$0	
White Nylon Base (For White Frame FC12)	B20	+ \$0	
Polished Aluminum Base	B16	+ \$119	

Nylon bases must pair with their corresponding frame color. Polished aluminum base (B16) can be used with either frame color.

5. Base (Cont.)

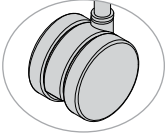
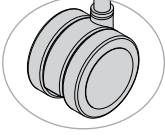
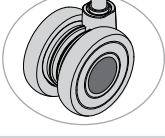
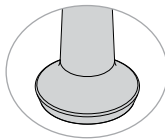
Casters or Glides	Code	Price	
Casters			
Carpet Casters	C25	+ \$0	
Hard Floor and Carpet Casters	C26	+ \$45	
Designer Casters	C30	+ \$119	
Glides			
Glides for Task Chairs	C3	+ \$35	



Good
Featured with an Electric Blue mesh

TASK CHAIR

6. Material

Protection	Code	Price	
Fire Retardancy			
CAL 133, Fabric, Quantities 1–49	133F	+ \$99	
CAL 133, Fabric, Quantities 50+	133F5	+ \$55	
CAL 133, Leather, Any Quantity	133L	+ \$119	
Mesh Color	Code	Price	
Desert Solid Mesh	MC9	+ \$0	
Desert Striped Mesh	MC16	+ \$0	
Electric Blue Solid Mesh	MC13	+ \$0	
Fire Solid Mesh	MC10	+ \$0	
Fog Solid Mesh	MC7	+ \$0	
Fog Striped Mesh	MC15	+ \$0	
Navy Solid Mesh	MC8	+ \$0	
Nickel Solid Mesh	MC6	+ \$0	
Onyx Solid Mesh	MC5	+ \$0	
Onyx Striped Mesh	MC14	+ \$0	
Seat Textile	Code	Price	
Fabric/Vinyl Grade 1	FG1/VG1	+ \$0	
COM	COM	+ \$30	
Fabric/Vinyl Grade 2	FG2/VG2	+ \$30	
Fabric/Vinyl Grade 3	FG3/VG3	+ \$60	
Fabric/Vinyl Grade 4	FG4/VG4	+ \$116	
Fabric/Vinyl Grade 5	FG5/VG5	+ \$172	
Fabric/Vinyl Grade 6	FG6/VG6	+ \$213	
Fabric/Vinyl Grade 7	FG7/VG7	+ \$254	
Leather Grade 1	LG1	+ \$300	
COL	COL	+ \$380	
Leather Grade 2	LG2	+ \$380	
Leather Grade 3	LG3	+ \$480	

Please reference the [Textile Reference Guide](#) for pricing on fabric over grade 7 and leather over grade 3. Additional CAL 133 information can be found on [page 15](#).

Please reference the Fabric information found on [page 17](#) for pricing on multi-upholstery.

7. Packaging

Packaging	Code	Price	
Knocked Down	KD	+ \$0	
Back Attached to Seat, Base Separate	UC	+ \$80	
Fully Assembled in a Carton	AC	+ \$200	

EFFECTIVE NOVEMBER 4, 2024 | GSA SIN #: 33721

SPECIFICATIONS

6023 Highback Mesh Task Chair	
Dimensions	
Overall Width Armless	26"
Overall Width With Arms	27"
Overall Depth	27.125"
Overall Height	44.5"
Seat Width	19"
Seat Depth	18"-20.25"
Seat Height	17.36"-21.75" 19"-23.75" (S13)
Back Width	19"
Back Height	22"
Materials	
COM	1 yd
COL	17 sq ft
Weight and Capacity	
Weight Armless	45 lb
Weight With Arms	50 lb
Weight Capacity Warranty	300 lb

Higher cylinder (S13).



*Best
Featured with Fog mesh and
SitOnIt Seating's Venice Gold Dusk*

TR2

TASK AND EXECUTIVE CHAIR

Ergonomics at work.

Classic ergonomic design and lifetime durability make the TR2™ a reliable task/executive chair. Six control and comfort mechanisms plus five arm options mean this chair is more versatile and comfortable than any other chair in its price range.



Best

EFFECTIVE NOVEMBER 4, 2024

Featured Models

GOOD :: \$928

Midback task, swivel-tilt mechanism, height-adjustable arms, black nylon base, carpet casters, grade 1 textile

BETTER :: \$1,014

Midback task, multi-function mechanism, height-adjustable arms, black nylon base, carpet casters, grade 1 textile

BEST :: \$1,102

Midback task, enhanced synchro mechanism with seat-depth adjustment, height-/width-adjustable arms with pivot, black nylon base, carpet casters, grade 1 textile

Features



- Internal back-height adjustment
- Five control mechanisms for motion and comfort
- Optional seat-depth adjustment
- Waterfall seat promotes proper leg circulation
- Five arm styles
- Molded foam seat cushion
- CAL 133 approved models
- 300 lb weight capacity warranty;
350 lb Heavy Duty 24/7 weight capacity warranty

1. Back

Back Size and Style	Code	Price	
Midback Task	40	\$1,014	

Highback Executive	40E	\$1,089	
--------------------	-----	---------	---

Back Options	Code	Price	
Upholstered Back	N	+ \$0	

Plastic Back for Task	E4	+ \$0	
Plastic Back for Executive	E5	+ \$0	

Plastic back (E4/E5) requires posture back (P) or multi-function (M) mechanism.

2. Super Duty

Super Duty Series	Code	Price	
Heavy Duty	HD	+ \$200	

Available with enhanced synchro (Y) or multi-function (M) mechanism only.
See the Super Duty Guide on [page 626](#) for additional LT and HD options.

TASK AND EXECUTIVE CHAIR

3. Seat

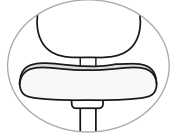
Seat Options	Code	Price	
1" Additional Foam	F1	+ \$36	

4. Mechanism

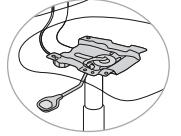
Mechanism Style	Code	Price	
Basic (Swivel Only)	B	- \$101	

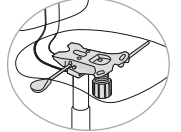
Swivel-Tilt	T	- \$86	
-------------	---	--------	---

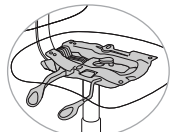
Posture Back	P	- \$54	
--------------	---	--------	--

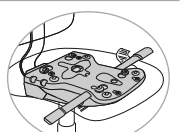
Enhanced Synchro	Y	- \$36	
------------------	---	--------	---

Multi-Function	M	+ \$0	
----------------	---	-------	---

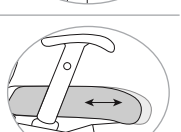
Posture Back With Seat-Depth Adjustment	P E3	+ \$25	
---	------	--------	---

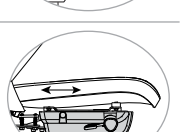
Enhanced Synchro Seat-Depth Adjustment	Y E3	+ \$43	
--	------	--------	---

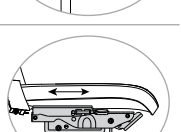

Multi-Function With Seat-Depth Adjustment	M E3	+ \$79	
---	------	--------	---

Basic mechanism (B) not available on highback executive model (40E).

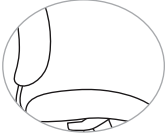
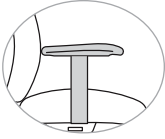
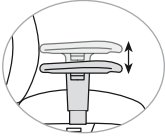
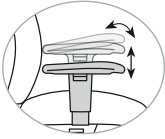
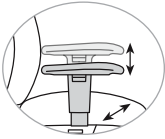
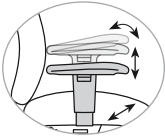
5. Arms

Arm Style	Code	Price	
Armless	A0	- \$80	
Fixed Pad	A12	- \$10	
Height-Adjustable	A15	+ \$0	
Height-Adjustable With Pivot	A43	+ \$10	
Height-/Width-Adjustable	A17	+ \$35	
Height-/Width-Adjustable With Pivot	A44	+ \$45	

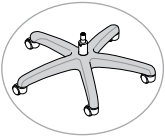
6. Base

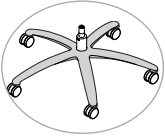
Base Color and Material	Code	Price	
Black Nylon Base	B0	+ \$0	
Heavy Duty Black Nylon Base, 26"	B7	+ \$0	
Brushed Aluminum Base	B2	+ \$119	

TASK AND EXECUTIVE CHAIR

6. Base (Cont.)

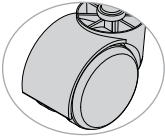
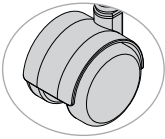
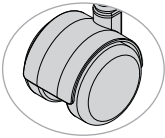
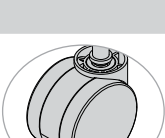
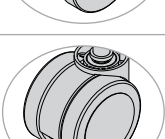
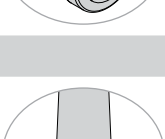
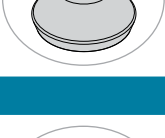
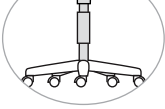
Casters or Glides	Code	Price	
Casters (For Black Base Only)			
Carpet Casters	C5	+ \$0	
Hard Floor and Carpet Casters	C1	+ \$45	
Self-Locking Carpet Casters	C2	+ \$30	
Self-Locking Hard Floor and Carpet Casters	C7	+ \$61	
Heavy Duty Casters			
Heavy Duty Carpet Casters	C11	+ \$0	
Heavy Duty Hard Floor and Carpet Casters	C9	+ \$61	
Glides			
Glides for Task Chairs	C3	+ \$35	
Cylinder Height	Code	Price	
Cylinder Extension Kit	S3	+ \$89	

Glides (C3) are for black base only. Self-locking casters (C2/C7) lock only when chair is not in use.
Cylinder extension kit (S3) is only available with basic (B) or posture back (P) mechanisms.

7. Material

Protection	Code	Price
Fire Retardancy		
CAL 133, Fabric, Quantities 1–49	133F	+ \$99
CAL 133, Fabric, Quantities 50+	133F5	+ \$55
Ballistic Nylon Back	Code	Price
Ballistic Nylon Back	BN	+ \$0
Seat and Back Textile	Code	Price
Fabric/Vinyl Grade 1	FG1/VG1	+ \$0
COM	COM	+ \$40
Fabric/Vinyl Grade 2	FG2/VG2	+ \$40
Fabric/Vinyl Grade 3	FG3/VG3	+ \$74
Fabric/Vinyl Grade 4	FG4/VG4	+ \$121
Fabric/Vinyl Grade 5	FG5/VG5	+ \$174
Fabric/Vinyl Grade 6	FG6/VG6	+ \$235
Fabric/Vinyl Grade 7	FG7/VG7	+ \$296
Leather Grade 1	LG1	+ \$340
COL	COL	+ \$460
Leather Grade 2	LG2	+ \$460
Leather Grade 3	LG3	+ \$600

Please reference the [Textile Reference Guide](#) for pricing on fabric over grade 7 and leather over grade 3. Additional CAL 133 information can be found on [page 15](#).

Please reference the [Fabric information found on page 17](#) for pricing on multi-upholstery.

8. Packaging

Packaging	Code	Price
Knocked Down	KD	+ \$0
Back Attached to Seat, Base Separate	UC	+ \$80
Fully Assembled in a Carton	AC	+ \$200

SPECIFICATIONS

	40 Midback Task	40E Highback Executive
Dimensions		
Overall Width	26"	26"
Overall Depth	26"	26"
Overall Height	36"	40.5"
Seat Width	20"	21"
Seat Depth	18"	20"
Seat Height	16.5"–21"	16.5"–21"
Back Width	18"	20"
Back Height	19.5"	24"
Materials		
COM	1.5 yd 1.25 yd (BN)	2 yd 1.7 yd (BN)
COL	25 sq ft 20 sq ft (BN)	36 sq ft 30 sq ft (BN)
Weight and Capacity		
Weight Armless	38 lb (B)	N/A (B)
	41 lb (T)	44 lb (T)
	42 lb (P)	45 lb (P)
	45 lb (Y)	45 lb (Y)
	48 lb (M)	51 lb (M)
Weight With Arms	43 lb (B)	N/A (B)
	46 lb (T)	49 lb (T)
	47 lb (P)	50 lb (P)
	50 lb (Y)	50 lb (Y)
	47 lb (M)	56 lb (M)
Weight Capacity Warranty	300 lb	300 lb
	350 lb (Y/M) (HD)	350 lb (Y/M) (HD)

Basic mechanism (B). Swivel-tilt mechanism (T). Posture back mechanism (P). Enhanced synchro mechanism (Y). Multi-function mechanism (M). Ballistic nylon back (BN).

TR2

TASK STOOL

Ergonomics at work.

The efficient, modest lines of the TR2 collection mimic the state of business: robust, reliable and not wasting a single step. Two control and comfort mechanisms plus five arm options create a multitude of customization opportunities that make this classic task stool more versatile and comfortable than any other in its price range.



EFFECTIVE NOVEMBER 4, 2024

Featured Models

GOOD :: \$1,027

Midback stool, basic mechanism, armless, standard stool kit, black nylon base, carpet casters, grade 1 textile

BETTER :: \$1,107

Midback stool, basic mechanism, height-adjustable arms, standard stool kit, black nylon base, carpet casters, grade 1 textile

BEST :: \$1,213

Midback stool, posture back mechanism, height-/width-adjustable arms, extended stool kit, black nylon base, carpet casters, grade 1 textile

Features

- Two control mechanisms for motion and comfort
- Waterfall seat
- Five arm styles
- Molded foam seat cushion
- 300 lb weight capacity warranty;
350 lb Heavy Duty 24/7 weight capacity warranty

1. Back

Back Size and Style	Code	Price	
Midback Task	40	\$1,154	

Back Options	Code	Price	
Upholstered Back	N	+ \$0	

Plastic Back for Task	E4	+ \$0	
-----------------------	----	-------	---

Plastic back (E4) requires posture back (P) mechanism.

2. Seat

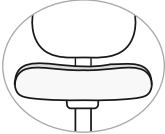
Seat Options	Code	Price	
1" Additional Foam	F1	+ \$36	



3. Heavy Duty

Heavy Duty Series	Code	Price	
Heavy Duty	HD	+ \$200	

Heavy Duty mechanism (HD) requires heavy duty stool kit (S1HD/S2HD) and heavy duty basic mechanism.

TASK STOOL

4. Mechanism

Mechanism Style	Code	Price	
Basic (Swivel Only)	B	- \$47	
Heavy Duty Basic (Swivel Only)	B2	+ \$0	
Posture Back	P	+ \$0	

Heavy duty basic mechanism (B2) is only available on heavy duty (HD) models.

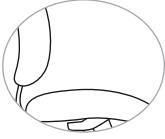
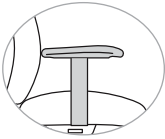
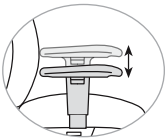
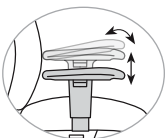
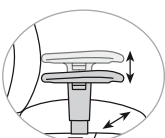
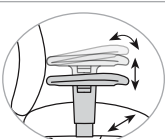

5. Arms

Arm Style	Code	Price	
Armless	A0	- \$80	
Fixed Pad	A12	- \$10	
Height-Adjustable	A15	+ \$0	
Height-Adjustable With Pivot	A43	+ \$10	
Height-/Width-Adjustable	A17	+ \$35	
Height-/Width-Adjustable With Pivot	A44	+ \$45	

6. Base

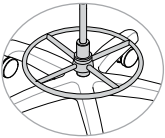
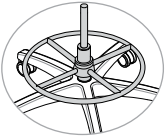
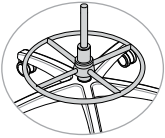
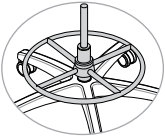
Base	Code	Price	
Standard Stool Kit	S1	+ \$0	
Extended Stool Kit	S2	+ \$24	
Heavy Duty Stool Kit	S1HD	+ \$0	
Heavy Duty Extended Stool Kit	S2HD	+ \$24	

TASK STOOL

6. Base (Cont.)

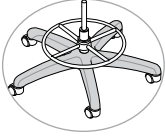
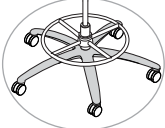
Base Color and Material	Code	Price	
Black Nylon Base	B0	+ \$0	
Brushed Aluminum Base	B2	+ \$119	

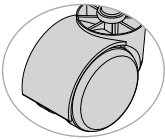
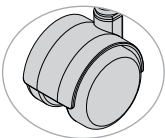
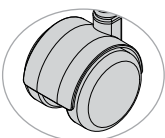
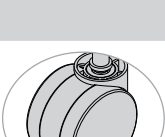
Casters or Glides	Code	Price	
Casters (For Black Base Only)			
Black Carpet Casters	C5	+ \$0	
Hard Floor and Carpet Casters	C1	+ \$45	
Self-Locking Carpet Casters	C2	+ \$30	
Self-Locking Hard Floor and Carpet Casters	C7	+ \$61	

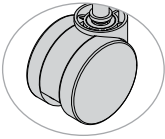
Heavy Duty Casters			
Heavy Duty Carpet Casters	C11	+ \$0	
Heavy Duty Hard Floor and Carpet Casters	C9	+ \$61	

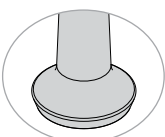
Glides			
Glides for Task Chairs	C3	+ \$35	

Self-locking casters (C2/C7) lock only when chair is not in use.

7. Material

Protection	Code	Price
Fire Retardancy		
CAL 133, Fabric, Quantities 1–49	133F	+ \$99
CAL 133, Fabric, Quantities 50+	133F5	+ \$55
CAL 133, Leather, Any Quantity	133L	+ \$119
Ballistic Nylon	Code	Price
Ballistic Nylon Back	BN	+ \$0
Seat and Back Textile	Code	Price
Fabric/Vinyl Grade 1	FG1/VG1	+ \$0
COM	COM	+ \$40
Fabric/Vinyl Grade 2	FG2/VG2	+ \$40
Fabric/Vinyl Grade 3	FG3/VG3	+ \$74
Fabric/Vinyl Grade 4	FG4/VG4	+ \$121
Fabric/Vinyl Grade 5	FG5/VG5	+ \$174
Fabric/Vinyl Grade 6	FG6/VG6	+ \$235
Fabric/Vinyl Grade 7	FG7/VG7	+ \$296
Leather Grade 1	LG1	+ \$340
COL	COL	+ \$460
Leather Grade 2	LG2	+ \$460
Leather Grade 3	LG3	+ \$600

Please reference the [Textile Reference Guide](#) for pricing on fabric over grade 7 and leather over grade 3. Additional CAL 133 information can be found on [page 15](#).

Please reference the [Fabric information](#) found on [page 17](#) for pricing on multi-upholstery.

8. Packaging

Packaging	Code	Price
Knocked Down	KD	+ \$0
Back Attached to Seat, Base Separate	UC	+ \$80
Fully Assembled in a Carton	AC	+ \$200

TASK STOOL

SPECIFICATIONS

	40 S1 Task Stool	40 S2 Extended Task Stool
Dimensions		
Overall Width	27"	27"
Overall Depth	27"	27"
Overall Height	39"	43"
Seat Width	20"	20"
Seat Depth	19" 18" (HD)	18" 18" (HD)
Seat Height	19"–27" (B) 19.5"–27.5" (P)	23"–33" (B) 23.5"–33.5" (P)
Back Width	18"	18"
Back Height	21"	21"
Materials		
COM	1.5 yd 1.25 yd (BN)	1.5 yd 1.25 yd (BN)
COL	25 sq ft 20 sq ft (BN)	25 sq ft 20 sq ft (BN)
Weight and Capacity		
Weight Armless	42 lb (B) 45 lb (P) 43 lb (B2)(HD)	43 lb 43 lb (B2)(HD)
Weight With Arms	45 lb (B) 50 lb (P) 48 lb (B2) (HD)	48 lb 48 lb (B2) (HD)
Weight Capacity Warranty	300 lb 350 lb (HD)	300 lb 350 lb (HD)

Heavy Duty model (HD). Basic mechanism (B). Posture back mechanism (P). Heavy Duty mechanism (B2). Ballistic nylon back (BN).

Vectra

MESH BACK TASK CHAIR

Experience beyond.

Meet our most advanced product yet. Vectra™ is next-gen intelligent design with smart features promising smarter solutions. It's a super-slim, precision-engineered package built to deliver robust on-demand comfort and the kind of cutting-edge innovation that redefines an entire category.



Best
Featured with Navy mesh and
SitOnIt Seating's Dash —Midnight

EFFECTIVE NOVEMBER 4, 2024

Featured Models

GOOD :: \$854

Highback mesh with adjustable lumbar, enhanced synchro mechanism, graphite frame, height-adjustable arms, graphite nylon base, carpet casters, grade 1 textile

BETTER :: \$947

Highback mesh with adjustable lumbar, advanced synchro mechanism with seat-depth adjustment, graphite frame, height-adjustable arms, graphite nylon base, carpet casters, grade 1 textile

BEST :: \$1,062

Highback mesh with adjustable lumbar, advanced synchro mechanism with seat-depth adjustment, fog frame, fully adjustable (8-way) arms, fog nylon base, carpet casters, grade 1 textile

Features

- Activate proprietary lumbar tension and support with quick-adjust slide knobs
- Five tilt-limiter back positions for comfort in various activities
- Seat tension adjusts quickly in less than two revolutions
- Match performance casters and base to three different frame colors
- Six colors of ultra-sheer micro mesh
- Customizable arm triggers, caster rings and lumbar adjustment carriage with 13 accent colors
- Energizing ergonomics
- Aerodynamic flair with low-profile arms and slim graphite arm pads

1. Back

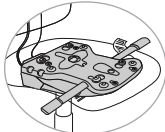
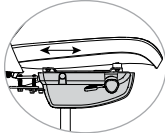
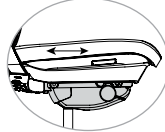

Back Size and Style	Code	Price	
Highback Mesh With Adjustable Lumbar Support	1073 BK2 MB	\$947	

2. Mechanism

Mechanism Style	Code	Price	
Enhanced Synchro	Y	-\$93	
Enhanced Synchro With Seat-Depth Adjustment	Y/E3	-\$54	
Advanced Synchro With Seat-Depth Adjustment	L/E3	+\$0	

MESH BACK TASK CHAIR

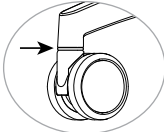
3. Frame

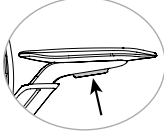
Frame Color	Code	Price	
Graphite	FC11	+\$0	
White	FC12	+\$45	
Fog	FC13	+\$45	
Accent Color	Code	Price	
Apple	LA12	+\$0	
Desert	LA3	+\$0	
Electric Blue	LA5	+\$0	
Fire	LA6	+\$0	
Fog	LA4	+\$0	
Graphite	LA14	+\$0	
Lemon	LA8	+\$0	
Navy	LA15	+\$0	
Nickel	LA2	+\$0	
Onyx	LA1	+\$0	
Platinum	LA16	+\$0	
Tangerine	LA9	+\$0	
White	LA13	+\$0	

Accent color applies to lumbar adjustment, arm adjustment buttons and caster rings.

4. Arms

Arm Style	Code	Price	
Armless	AR0	- \$45	
Fixed Arms	AR2	- \$10	
Height-Adjustable	AR4	+ \$0	
Height-/Width-Adjustable	AR6	+ \$35	
Fully Adjustable (8-Way)	AR9	+ \$70	

5. Base

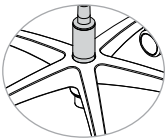
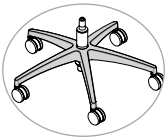
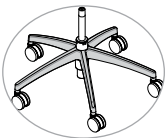
Base Color and Material	Code	Price	
Cylinder Height	Code	Price	
Standard Cylinder	CH1	+ \$0	
Higher Cylinder	CH3	+ \$0	
Lower Cylinder	CH4	+ \$0	
Graphite Nylon Base (For Graphite Frame FC11)	B14	+ \$0	
Fog Nylon Base (For Fog Frame FC13)	B21	+ \$0	
White Nylon Base (For White Frame FC12)	B20	+ \$0	
Polished Aluminum Base	B18	+ \$119	

Nylon base color must match frame color. Aluminum base (B18) can be used with any frame color. Polished aluminum base (B18) is not available with lower cylinder (CH4).

MESH BACK TASK CHAIR

5. Base (Cont.)

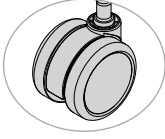
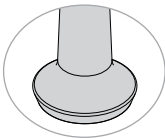
Casters or Glides	Code	Price	
Casters			
Carpet Casters	CS5	+ \$0	
Hard Floor and Carpet Casters	CS6	+ \$45	
Glides			
Glides for Task Chairs	CS3	+ \$35	

Caster color coordinates with frame color. Lower cylinder (CH4) is not available with polished aluminum base (B18).

6. Material

Mesh Color	Code	Price	
Desert	MC9	+ \$0	
Mist	MC41	+ \$0	
Navy	MC8	+ \$0	
Nickel	MC6	+ \$0	
Onyx	MC5	+ \$0	
Platinum	MC42	+ \$0	
Seat Textile	Code	Price	
Fabric/Vinyl Grade 1	FG1/VG1	+ \$0	
COM	COM	+ \$30	
Fabric/Vinyl Grade 2	FG2/VG2	+ \$30	
Fabric/Vinyl Grade 3	FG3/VG3	+ \$60	
Fabric/Vinyl Grade 4	FG4/VG4	+ \$116	
Fabric/Vinyl Grade 5	FG5/VG5	+ \$172	
Fabric/Vinyl Grade 6	FG6/VG6	+ \$213	
Fabric/Vinyl Grade 7	FG7/VG7	+ \$254	
Leather Grade 1	LG1	+ \$300	
COL	COL	+ \$380	
Leather Grade 2	LG2	+ \$380	
Leather Grade 3	LG3	+ \$480	

Please reference the [Textile Reference Guide](#) for pricing on fabric over grade 7 and leather over grade 3.

EFFECTIVE NOVEMBER 4, 2024 | GSA SIN #: 33721

7. Packaging

Packaging	Code	Price
Knocked Down	KD	+ \$0
Back Attached to Seat, Base Separate	UC	+ \$80
Fully Assembled in a Carton	AC	+ \$200

SPECIFICATIONS

1073.BK2.MB Highback Mesh Task Chair	
Dimensions	
Overall Width Armless	26"
Overall Width With Arms	27"
Overall Depth	25"
Overall Height	38" (L/E3), 38.5" (Y/E3)
Seat Width	19.75"
Seat Depth	17"
Seat Height Short Cylinder	15.5"–17.63" (L/E3) 16"–18.1" (Y/E3)
Seat Height Standard Cylinder	16.5"–20.75" 17"–21.25" (Y/E3)
Seat Height High Cylinder	18.25"–22.63" (L/E3), 18.75"–23.1" (Y/E3)
Back Width	20.5"
Back Height	23"
Materials	
COM	1.1 yd
COL	20 sq ft
Weight and Capacity	
Weight Armless	30 lb
Weight With Arms	33 lb (L/E3), 41 lb (Y/E3)
Weight Capacity Warranty	300 lb

Enhanced synchro with seat-depth Adjustment (Y/E3). Advanced synchro with seat-depth adjustment (L/E3)



Better
Featuring Nickel mesh and
SitOnIt Seating's Spice – Fire

Wit

MESH BACK TASK CHAIR

Work smarter.

Gone are the days where you clock in, stay in your cubicle and clock out. Dynamic environments call for adaptable seating that rolls with the punches. Our Wit™ family does exactly that. Because this is a design inspired by truths about how people work.

Today's ever-changing marketplace calls for flexibility. Teams need to be able to set up shop anywhere—and at any time. All of our Wit task models are easily adjustable so anyone can find a seat, settle in and get right to work.



Best
Featured with Fog Woven Striped mesh
and SitOnIt Seating's Venice — Mainstream

EFFECTIVE NOVEMBER 4, 2024

Featured Models

GOOD :: \$652

Midback, swivel-tilt mechanism, height-adjustable arms, black frame, black nylon base, carpet casters, grade 1 textile

BETTER :: \$702

Highback, standard synchro mechanism, height-adjustable arms, black frame, black nylon base, carpet casters, grade 1 textile

BEST :: \$861

Highback, standard synchro mechanism with seat-depth adjustment, multi-adjustable arms, white frame, white nylon base, carpet casters, grade 1 textile

Features

- Midback and highback task chairs
- Standard adjustable lumbar support
- Built-in pull handle
- 12 solid mesh back colors
- Four woven striped mesh options
- Three frame colors
- Standard synchro, swivel-tilt and basic mechanisms
- Multi-adjustable (height/width), height-adjustable, armless and fixed arms
- Textured designer arms
- Optional seat-depth adjustment
- Optional brushed aluminum base
- Waterfall seat
- Standard 300 lb weight capacity warranty
- Complemented by Wit Side; see [page 299](#)

1. Back

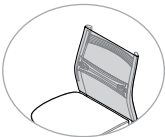
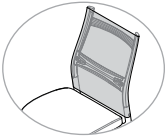
Back Size and Style	Code	Price	
Midback Mesh With Adjustable Lumbar Support	2222 B1	\$667	
Highback Mesh With Adjustable Lumbar Support	2223 B1	\$702	

MESH BACK TASK CHAIR

2. Mechanism

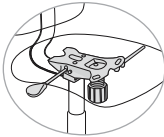
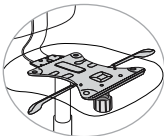
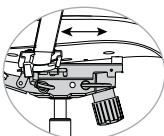
Mechanism Style	Code	Price	
Basic (Swivel Only)	B	- \$30	
Swivel-Tilt	T	- \$15	
Standard Synchro	F	+ \$0	
Standard Synchro With Seat-Depth Adjustment	F E3	+ \$79	

3. Frame

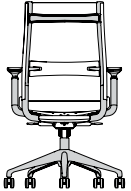
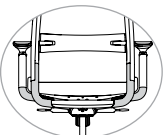

Frame Color	Code	Price	
Black	FC1	+ \$0	
White	FC12	+ \$45	
Fog	FC13	+ \$45	
Back Support Color	Code	Price	
Black (For Black Frame FC1)	Z1	+ \$0	
Silver (For Black Frame FC1)	Z2	+ \$0	
White (For White Frame FC12)	Z4	+ \$0	
Fog (For Fog Frame FC13)	Z7	+ \$0	

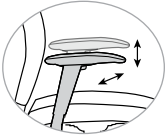
4. Arms

Arm Style	Code	Price	
Armless	A0	- \$45	
Fixed	A127	- \$10	
Height-Adjustable	A128	+ \$0	
Multi-Adjustable (Height/Width)	A129	+ \$35	

Arms, if specified, come with fog arm pads for the white and fog frames and black arm pads for the black frame.

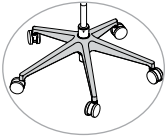
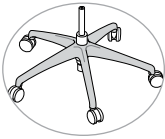
5. Base

Base Color and Material	Code	Price	
Black Nylon Base With Black Casters (For Black Frame FC1)	B0	+ \$0	
White Nylon Base With Fog/White Casters (For White Frame FC12)	B20	+ \$0	
Fog Nylon Base With Fog Casters (For Fog Frame FC13)	B21	+ \$0	
Brushed Aluminum Base	B8	+ \$119	
Heavy Duty Black Base, 26"	B7	+ \$0	

Heavy duty black base (B7) requires lower cylinder. Brushed aluminum base (B8) can be used with any frame color.

Chairs configured with the brushed aluminum base (B8) and standard synchro (F) mechanism ship with the High cylinder (S13)

MESH BACK TASK CHAIR

5. Base (Cont.)

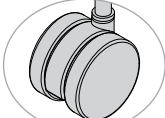
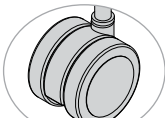
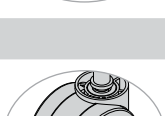
Casters or Glides	Code	Price	
Casters			
Black Carpet Casters (for Black Frame – FC1)	C16	+ \$0	
Black Hard Floor and Carpet Casters (For Black Frame FC1)	C17	+ \$45	
Hard Floor and Carpet Casters (For Fog or White Frame FC12/FC13)	CS6	+ \$0	

Heavy Duty Casters

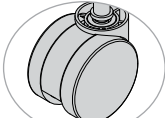
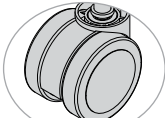
Heavy Duty Carpet Casters	C11	+ \$0	
Heavy Duty Hard Floor and Carpet Casters	C9	+ \$61	

Glides

Glides for Task Chairs	C3	+ \$35	
------------------------	----	--------	---

Cylinder Height	Code	Price	
Standard Cylinder	S0	+ \$0	
Higher Cylinder	S13	+ \$0	
Lower Cylinder	S10	+ \$0	

Lower cylinder (S10) is available with Heavy Duty (B7) black base only. Higher cylinder (S13) is required on chairs configured with the brushed aluminum base (B8) and standard synchro (F) mechanism.

6. Material

Protection	Code	Price	
Fire Retardancy			
CAL 133, Fabric, Quantities 1–49	133F	+ \$99	
CAL 133, Fabric, Quantities 50+	133F5	+ \$55	
CAL 133, Leather, Any Quantity	133L	+ \$119	

6. Material (Cont.)

Mesh Color	Code	Price
Solid Mesh		
Apple	MC31	+ \$0
Aqua	MC30	+ \$0
Desert	MC22	+ \$0
Electric Blue	MC24	+ \$0
Fire	MC25	+ \$0
Fog	MC23	+ \$0
Grape	MC26	+ \$0
Lemon	MC27	+ \$0
Nickel	MC21	+ \$0
Ocean	MC29	+ \$0
Onyx	MC20	+ \$0
Tangerine	MC28	+ \$0
Woven Striped Mesh		
Fog	MC37	+ \$0
Frost	MC36	+ \$0
Nickel	MC38	+ \$0
Onyx	MC35	+ \$0
Seat Textile	Code	Price
Fabric/Vinyl Grade 1	FG1/VG1	+ \$0
COM	COM	+ \$30
Fabric/Vinyl Grade 2	FG2/VG2	+ \$30
Fabric/Vinyl Grade 3	FG3/VG3	+ \$60
Fabric/Vinyl Grade 4	FG4/VG4	+ \$116
Fabric/Vinyl Grade 5	FG5/VG5	+ \$172
Fabric/Vinyl Grade 6	FG6/VG6	+ \$213
Fabric/Vinyl Grade 7	FG7/VG7	+ \$254
Leather Grade 1	LG1	+ \$300
COL	COL	+ \$380
Leather Grade 2	LG2	+ \$380
Leather Grade 3	LG3	+ \$480

Please reference the [Textile Reference Guide](#) for pricing on fabric over grade 7 and leather over grade 3. Additional CAL 133 information can be found on [page 15](#).

7. Packaging

Packaging	Code	Price
Knocked Down	KD	+ \$0
Back Attached to Seat, Base Separate	UC	+ \$80
Fully Assembled in a Carton	AC	+ \$200

MESH BACK TASK CHAIR

SPECIFICATIONS

	2222 B1 Midback Mesh Task Chair	2223 B1 Highback Mesh Task Chair
Dimensions		
Overall Width Armless	25"	25"
Overall Width With Arms	26"	26"
Overall Depth	25"	25"
Overall Height	36.75"	40.75"
Seat Width	20"	20"
Seat Depth	17.5"-19.5"	17.5"-19.5"
Seat Height	17.5"-21.25" (F/T) 16.63"-20.38" (B) 17.75"-21.5" (F/E3)	17.5"-21.25" (F/T) 16.63"-20.38" (B) 17.75"-21.5" (F/E3)
Seat Height With Higher Cylinder	19"-22.5" (F/T) 18"-21.5" (B) 19"-22.5" (F/E3)	19"-22.5" (F/T) 18"-21.5" (B) 19"-22.5" (F/E3)
Seat Height With Lower Cylinder (B7)	15"-18" (B) 15.5"-18.5" (T) 15.63"-18.68" (F) 16"-19" (F/E3)	15"-18" (B) 15.5"-18.5" (T) 15.63"-18.68" (F) 16"-19" (F/E3)
Back Width	18.75"	18.75"
Back Height	19"	23"
Materials		
COM	1 yd	1 yd
COL	17 sq ft	17 sq ft
Weight and Capacity		
Weight Armless	30 lb	31 lb
Weight With Arms	36 lb	37 lb
Weight Capacity Warranty	300 lb	300 lb

Basic mechanism (B). Swivel-tilt mechanism (T). Standard synchro mechanism (F). Seat-depth adjustment (E3).

Wit

MESH BACK TASK STOOL

Work smarter.

Gone are the days where you clock in, stay in your cubicle and clock out. Dynamic environments call for adaptable seating that rolls with the punches. Our Wit™ family does exactly that. Because this is a design inspired by truths about how people work.

Today's ever-changing marketplace calls for flexibility. Teams need to be able to set up shop anywhere—and at any time. All of our Wit task models are easily adjustable so anyone can find a seat, settle in and get right to work.



Best
Featured with Frost Woven Striped mesh and SitOnIt Seating's Malibu — Smoke

EFFECTIVE NOVEMBER 4, 2024

Featured Models

GOOD :: \$732

Midback mesh with adjustable lumbar, basic mechanism, armless, black frame, standard stool kit, carpet casters, grade 1 textile

BETTER :: \$777

Midback mesh with adjustable lumbar, basic mechanism, height-adjustable arms, black frame, standard stool kit, carpet casters, grade 1 textile

BEST :: \$881

Midback mesh with adjustable lumbar, basic mechanism, multi-adjustable arms, white frame, extended stool kit, carpet casters, grade 1 textile

Features

- Midback task stool
- Standard adjustable lumbar support
- Built-in pull handle
- 12 solid mesh back colors
- Four woven striped mesh options
- Three frame colors
- Basic mechanism
- Multi-adjustable (height/width), height-adjustable, armless and fixed arms
- Textured designer arms
- Optional brushed aluminum base
- Waterfall seat
- Standard 300 lb weight capacity warranty
- Complemented by Wit Side; see [page 299](#)

1. Back

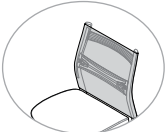
Back Size and Style	Code	Price	
Midback Mesh With Adjustable Lumbar Support	2222 B1	\$777	

2. Mechanism

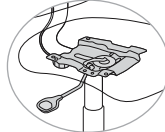

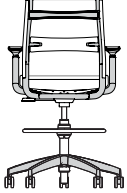
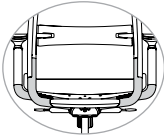

Mechanism	Code	Price	
Basic (Swivel Only)	B	+ \$0	

MESH BACK TASK STOOL

3. Frame

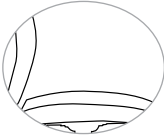
Frame Color	Code	Price	
Black	FC1	+ \$0	
White	FC12	+ \$45	
Fog	FC13	+ \$45	
Back Support Color	Code	Price	
Black (For Black Frame FC1)	Z1	+ \$0	
Silver (For Black Frame FC1)	Z2	+ \$0	
White (For White Frame FC12)	Z4	+ \$0	
Fog (For Fog Frame FC13)	Z7	+ \$0	

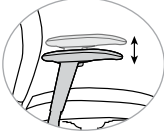
4. Arms

Arm Style	Code	Price	
Armless	A0	- \$45	
Fixed	A127	- \$10	
Height-Adjustable	A128	+ \$0	
Multi-Adjustable (Height/Width)	A129	+ \$35	

Arms, if specified, come with fog arm pads for the white and fog frames and black arm pads for the black frame.

5. Base

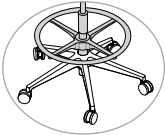
Base	Code	Price	
Stool Kit	S1	+ \$0	
Extended Stool Kit	S2	+ \$24	

Base Color and Material	Code	Price	
Black Nylon Base With Black Casters (For Black Frame FC1)	B0	+ \$0	
White Nylon Base With Fog/White Casters (For White Frame FC12)	B20	+ \$0	
Fog Nylon Base With Fog Casters (For Fog Frame FC13)	B21	+ \$0	

Brushed Aluminum Base	B8	+ \$119	
-----------------------	----	---------	---

Casters or Glides	Code	Price	
Casters			

Black Carpet Casters (For Black Frame FC1)	C16	+ \$0	
---	-----	-------	---

Black Hard Floor and Carpet Casters (For Black Frame FC1)	C17	+ \$45	
Hard Floor and Carpet Casters (For Fog or White Frame FC12/FC13)	CS6	+ \$0	

Glides			
Glides for Task Chairs	C3	+ \$35	

Brushed aluminum base (B8) can be used with any frame color.

6. Material

Protection	Code	Price	
Fire Retardancy			
CAL 133, Fabric, Quantities 1-49	133F	+ \$99	
CAL 133, Fabric, Quantities 50+	133F5	+ \$55	
CAL 133, Leather, Any Quantity	133L	+ \$119	

MESH BACK TASK STOOL

6. Material (Cont.)

Mesh Color	Code	Price	
Solid Mesh			
Apple	MC31	+ \$0	
Aqua	MC30	+ \$0	
Desert	MC22	+ \$0	
Electric Blue	MC24	+ \$0	
Fire	MC25	+ \$0	
Fog	MC23	+ \$0	
Grape	MC26	+ \$0	
Lemon	MC27	+ \$0	
Nickel	MC21	+ \$0	
Ocean	MC29	+ \$0	
Onyx	MC20	+ \$0	
Tangerine	MC28	+ \$0	

Woven Striped Mesh			
Fog	MC37	+ \$0	
Frost	MC36	+ \$0	
Nickel	MC38	+ \$0	
Onyx	MC35	+ \$0	

Seat Textile	Code	Price	
Fabric/Vinyl Grade 1	FG1/VG1	+ \$0	
COM	COM	+ \$30	
Fabric/Vinyl Grade 2	FG2/VG2	+ \$30	
Fabric/Vinyl Grade 3	FG3/VG3	+ \$60	
Fabric/Vinyl Grade 4	FG4/VG4	+ \$116	
Fabric/Vinyl Grade 5	FG5/VG5	+ \$172	
Fabric/Vinyl Grade 6	FG6/VG6	+ \$213	
Fabric/Vinyl Grade 7	FG7/VG7	+ \$254	
Leather Grade 1	LG1	+ \$300	
COL	COL	+ \$380	
Leather Grade 2	LG2	+ \$380	
Leather Grade 3	LG3	+ \$480	

Please reference the [Textile Reference Guide](#) for pricing on fabric over grade 7 and leather over grade 3. Additional CAL 133 information can be found on [page 15](#).

7. Packaging

Packaging	Code	Price	
Knocked Down	KD	+ \$0	
Back Attached to Seat, Base Separate	UC	+ \$80	
Fully Assembled in a Carton	AC	+ \$200	

EFFECTIVE NOVEMBER 4, 2024 | GSA SIN #: 33721

SPECIFICATIONS

	2222 B1 S1 Midback Mesh Task Stool	2222 B1 S2 Midback Mesh Extended Task Stool
Dimensions		
Overall Width	27"	27"
Overall Depth	27"	27"
Overall Height	45.63"	50"
Seat Width	20"	20"
Seat Depth	17.5"	17.5"
Seat Height	22"- 30"	26"-36"
Back Width	19"	19"
Back Height	18.75"	18.75"
Materials		
COM	1 yd	1 yd
COL	17 sq ft	17 sq ft
Weight and Capacity		
Weight Armless	28.5 lb	29.5 lb
Weight With Arms	34.5 lb	35.5 lb
Weight Capacity Warranty	300 lb	300 lb



Wit

THINTEX BACK TASK CHAIR

Work smarter.

Gone are the days where you clock in, stay in your cubicle and clock out. Dynamic environments call for adaptable seating that rolls with the punches. Our Wit™ family does exactly that. Because this is a design inspired by truths about how people work.

Today's ever-changing marketplace calls for flexibility. Teams need to be able to set up shop anywhere—and at any time. All of our Wit task models are easily adjustable so anyone can find a seat, settle in and get right to work.



Best
Featured with Tangerine thintex
and SitOnIt Seating's Venice — Milestone

Featured Models

GOOD :: \$718

Midback, swivel-tilt mechanism, height-adjustable arms, black frame, black nylon base, carpet casters, grade 1 textile

BETTER :: \$768

Highback, standard synchro mechanism, height-adjustable arms, black frame, black nylon base, carpet casters, grade 1 textile

BEST :: \$927

Highback, standard synchro mechanism with seat-depth adjustment, multi-adjustable (height/width) arms, white frame, white nylon base, carpet casters, grade 1 textile



Features

- Midback and highback task chairs
- Standard adjustable lumbar support
- Built-in pull handle
- 12 Thintex back colors in fabric or vinyl
- Three frame colors
- Standard synchro, swivel-tilt and basic mechanisms
- Multi-adjustable (height/width), height-adjustable, armless and fixed arms
- Textured designer arms
- Optional seat-depth adjustment
- Optional brushed aluminum base
- Waterfall seat
- Standard 300 lb weight capacity warranty
- Complemented by Wit Side; see [page 302](#)

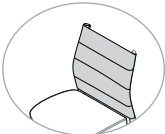
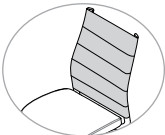
1. Back

Back Size and Style	Code	Price	
Thintex Midback With Adjustable Lumbar Support	2222 B9	\$733	
Thintex Highback With Adjustable Lumbar Support	2223 B9	\$768	
Back Material	Code	Price	
Fabric	TX1	+ \$0	
Vinyl	TX2	+ \$0	

2. Mechanism

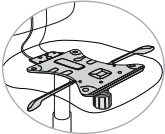
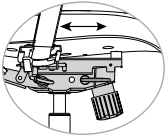
Mechanism Style	Code	Price	
Basic (Swivel Only)	B	- \$30	
Swivel-Tilt	T	- \$15	
Standard Synchro	F	+ \$0	
Standard Synchro With Seat-Depth Adjustment	F E3	+ \$79	

3. Frame

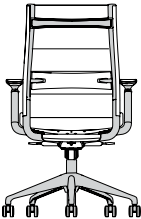
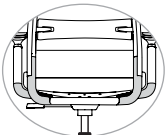

Frame Color	Code	Price	
Black	FC1	+ \$0	
White	FC12	+ \$45	
Fog	FC13	+ \$45	
Back Support Color	Code	Price	
Black (For Black Frame FC1)	Z1	+ \$0	
Silver (For Black Frame FC1)	Z2	+ \$0	
White (For White Frame FC12)	Z4	+ \$0	
Fog (For Fog Frame FC13)	Z7	+ \$0	

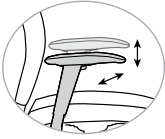
4. Arms

Arm Style	Code	Price	
Armless	A0	- \$45	
Fixed	A127	- \$10	
Height-Adjustable	A128	+ \$0	
Multi-Adjustable (Height/Width)	A129	+ \$35	

Arms, if specified, come with fog arm pads for the white and fog frames and black arm pads for the black frame.

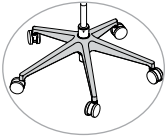
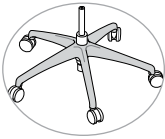
5. Base

Base Color and Material	Code	Price	
Black Nylon Base With Black Casters (For Black Frame FC1)	B0	+ \$0	
White Nylon Base With Fog/White Casters (For White Frame FC12)	B20	+ \$0	
Fog Nylon Base With Fog Casters (For Fog Frame FC13)	B21	+ \$0	
Brushed Aluminum Base	B8	+ \$119	
Heavy Duty Black Base, 26"	B7	+ \$0	

Heavy duty black base (B7) requires lower cylinder. Brushed aluminum base (B8) can be used with any frame color.

Chairs configured with the brushed aluminum base (B8) and standard synchro (F) mechanism ship with the High cylinder (S13)

THINTEX BACK TASK CHAIR

5. Base

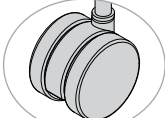
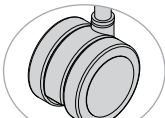
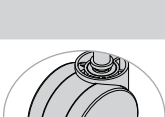
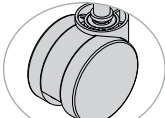
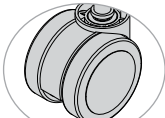
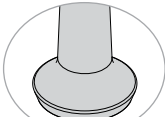
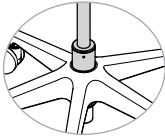
Casters or Glides	Code	Price	
Casters			
Black Carpet Casters (For Black Frame FC1)	C16	+ \$0	
Black Hard Floor and Carpet Casters (For Black Frame FC1)	C17	+ \$45	
Hard Floor and Carpet Casters (For Fog or White Frame FC12/FC13)	CS6	+ \$0	
Heavy Duty Casters			
Heavy Duty Carpet Casters	C11	+ \$0	
Heavy Duty Hard Floor and Carpet Casters	C9	+ \$61	
Glides			
Glides for Task Chairs	C3	+ \$35	
Cylinder Height	Code	Price	
Standard Cylinder	S0	+ \$0	
Higher Cylinder	S13	+ \$0	
Lower Cylinder	S10	+ \$0	

Lower cylinder (S10) is available with Heavy Duty (B7) black base only. Higher cylinder (S13) is required on chairs configured with the brushed aluminum base (B8) and standard synchro (F) mechanism.

6. Material

Protection	Code	Price	
Fire Retardancy			
CAL 133, Fabric, Quantities 1-49	133F	+ \$99	
CAL 133, Fabric, Quantities 50+	133F5	+ \$55	
CAL 133, Leather, Any Quantity	133L	+ \$119	

6. Material (Cont.)

Thintex Color	Code	Price
Apple	MC31	+ \$0
Aqua	MC30	+ \$0
Desert	MC22	+ \$0
Electric Blue	MC24	+ \$0
Fire	MC25	+ \$0
Fog	MC23	+ \$0
Grape	MC26	+ \$0
Lemon	MC27	+ \$0
Nickel	MC21	+ \$0
Ocean	MC29	+ \$0
Onyx	MC20	+ \$0
Tangerine	MC28	+ \$0
Tangerine	MC28	+ \$0
Seat Textile	Code	Price
Fabric/Vinyl Grade 1	FG1/VG1	+ \$0
COM	COM	+ \$30
Fabric/Vinyl Grade 2	FG2/VG2	+ \$30
Fabric/Vinyl Grade 3	FG3/VG3	+ \$60
Fabric/Vinyl Grade 4	FG4/VG4	+ \$116
Fabric/Vinyl Grade 5	FG5/VG5	+ \$172
Fabric/Vinyl Grade 6	FG6/VG6	+ \$213
Fabric/Vinyl Grade 7	FG7/VG7	+ \$254
Leather Grade 1	LG1	+ \$300
COL	COL	+ \$380
Leather Grade 2	LG2	+ \$380
Leather Grade 3	LG3	+ \$480

Please reference the [Textile Reference Guide](#) for pricing on fabric over grade 7 and leather over grade 3. Additional CAL 133 information can be found on [page 15](#).

7. Packaging

Packaging	Code	Price
Knocked Down	KD	+ \$0
Back Attached to Seat, Base Separate	UC	+ \$80
Fully Assembled in a Carton	AC	+ \$200

THINTEX BACK TASK CHAIR

SPECIFICATIONS

	2222 B9 Midback Thintex Task Chair	2223 B9 Highback Thintex Task Chair
Dimensions		
Overall Width	26"	26"
Overall Depth	26"	26"
Overall Height	36.75"	40.75"
Seat Width	20"	20"
Seat Depth	17.5"-19.5"	17.5"-19.5"
Seat Height	17.5"-21.25" (F/T) 16.63"-20.38" (B) 17.75"-21.5" (F/E3)	17.5"-21.25" (F/T) 16.63"-20.38" (B) 17.75"-21.5" (F/E3)
Seat Height With Higher Cylinder	19"-22.5" (F/T) 18"-21.5" (B) 19"-22.5" (F/E3)	19"-22.5" (F/T) 18"-21.5" (B) 19"-22.5" (F/E3)
Seat Height With Lower Cylinder (B7)	15.63"-18.68" (F) 15.5"-18.5" (T) 15"-18" (B) 16"-19" (F/E3)	15.63"-18.68" (F) 15.5"-18.5" (T) 15"-18" (B) 16"-19" (F/E3)
Back Width	18.75"	18.75"
Back Height	19"	23"
Materials		
COM	1 yd	1 yd
COL	17 sq ft	17 sq ft
Weight and Capacity		
Weight Armless	30 lb	31 lb
Weight With Arms	36 lb	37 lb
Weight Capacity Warranty	300 lb	300 lb

Basic mechanism (B). Swivel-tilt mechanism (T). Standard synchro mechanism (F). Seat-depth adjustment (E3).

Wit

THINTEX BACK TASK STOOL

Work smarter.

Gone are the days where you clock in, stay in your cubicle and clock out. Dynamic environments call for adaptable seating that rolls with the punches. Our Wit™ family does exactly that. Because this is a design inspired by truths about how people work.

Today's ever-changing marketplace calls for flexibility. Teams need to be able to set up shop anywhere—and at any time. All of our Wit task models are easily adjustable so anyone can find a seat, settle in and get right to work.



Best
Featured with Aqua thintex and SitOnIt Seating's Malibu — Smoke

Featured Models

GOOD :: \$798

Midback task stool with adjustable lumbar, basic mechanism, armless, black frame, standard stool kit, black nylon base, carpet casters, grade 1 textile

BETTER :: \$843

Midback task stool with adjustable lumbar, basic mechanism, height-adjustable arms, black frame, standard stool kit, black nylon base, carpet casters, grade 1 textile

BEST :: \$912

Midback task stool with adjustable lumbar, basic mechanism, height-adjustable arms, fog frame, extended stool kit, fog nylon base, carpet casters, grade 1 textile

Features

- Midback task stool
- Standard adjustable lumbar support
- Built-in pull handle
- 12 Thintex back colors in fabric or vinyl
- Three frame colors
- Basic mechanism
- Multi-adjustable (height/width), height-adjustable, armless and fixed arms
- Textured designer arms
- Optional brushed aluminum base
- Waterfall seat
- Standard 300 lb weight capacity warranty
- Complemented by Wit Side; see [page 302](#)

1. Back

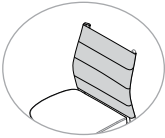
Back Size and Style	Code	Price	
Midback Thintex With Adjustable Lumbar Support	2222 B9	\$843	
Back Material	Code	Price	
Fabric	TX1	+ \$0	
Vinyl	TX2	+ \$0	

2. Mechanism



Mechanism	Code	Price	
Basic (Swivel Only)	B	+ \$0	

THINTEX BACK TASK STOOL

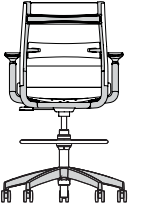
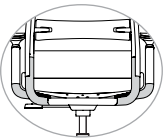
3. Frame

Frame Color	Code	Price	
Black	FC1	+ \$0	
White	FC12	+ \$45	
Fog	FC13	+ \$45	
Back Support Color	Code	Price	
Black (For Black Frame FC1)	Z1	+ \$0	
Silver (For Black Frame FC1)	Z2	+ \$0	
White (For White Frame FC12)	Z4	+ \$0	
Fog (For Fog Frame FC13)	Z7	+ \$0	

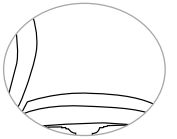
4. Arms

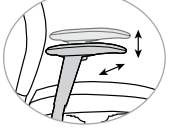
Arm Style	Code	Price	
Armless	A0	- \$45	
Fixed	A127	- \$10	
Height-Adjustable	A128	+ \$0	
Multi-Adjustable (Height/Width)	A129	+ \$35	

Arms, if specified, come with fog arm pads for the white and fog frames and black arm pads for the black frame.

5. Base

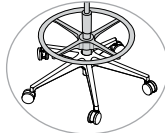
Base	Code	Price	
Stool Kit	S1	+ \$0	
Extended Stool Kit	S2	+ \$24	

Base Color and Material	Code	Price	
Black Nylon Base With Black Casters (For Black Frame FC1)	B0	+ \$0	
White Nylon Base With Fog/White Casters (For White Frame FC12)	B20	+ \$0	
Fog Nylon Base With Fog Casters (For Fog Frame FC13)	B21	+ \$0	

Brushed Aluminum Base	B8	+ \$119	
-----------------------	----	---------	---

Casters or Glides	Code	Price	
Casters			

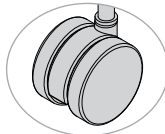
Black Carpet Casters (For Black Frame FC1)	C16	+ \$0	
--	-----	-------	---

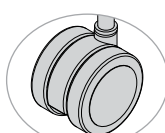
Black Hard Floor and Carpet Casters (For Black Frame FC1)	C17	+ \$45	
Hard Floor and Carpet Casters (For Fog or White Frame FC12/FC13)	CS6	+ \$0	

Glides			
---------------	--	--	--

Glides for Task Chairs	C3	+ \$35	
------------------------	----	--------	---

Brushed aluminum base (B8) can be used with any frame color.

THINTEX BACK TASK STOOL

6. Material

Protection	Code	Price	
Fire Retardancy			
CAL 133, Fabric, Quantities 1-49	133F	+ \$99	
CAL 133, Fabric, Quantities 50+	133F5	+ \$55	
CAL 133, Leather, Any Quantity	133L	+ \$119	

Thintex Color	Code	Price	
Apple	MC31	+ \$0	
Aqua	MC30	+ \$0	
Desert	MC22	+ \$0	
Electric Blue	MC24	+ \$0	
Fire	MC25	+ \$0	
Fog	MC23	+ \$0	
Grape	MC26	+ \$0	
Lemon	MC27	+ \$0	
Nickel	MC21	+ \$0	
Ocean	MC29	+ \$0	
Onyx	MC20	+ \$0	
Tangerine	MC28	+ \$0	

Seat Textile	Code	Price	
Fabric/Vinyl Grade 1	FG1/VG1	+ \$0	
COM	COM	+ \$30	
Fabric/Vinyl Grade 2	FG2/VG2	+ \$30	
Fabric/Vinyl Grade 3	FG3/VG3	+ \$60	
Fabric/Vinyl Grade 4	FG4/VG4	+ \$116	
Fabric/Vinyl Grade 5	FG5/VG5	+ \$172	
Fabric/Vinyl Grade 6	FG6/VG6	+ \$213	
Fabric/Vinyl Grade 7	FG7/VG7	+ \$254	
Leather Grade 1	LG1	+ \$300	
COL	COL	+ \$380	
Leather Grade 2	LG2	+ \$380	
Leather Grade 3	LG3	+ \$480	

Please reference the [Textile Reference Guide](#) for pricing on fabric over grade 7 and leather over grade 3. Additional CAL 133 information can be found on [page 15](#).

EFFECTIVE NOVEMBER 4, 2024 | GSA SIN #: 33721

7. Packaging

Packaging	Code	Price
Knocked Down	KD	+ \$0
Back Attached to Seat, Base Separate	UC	+ \$80
Fully Assembled in a Carton	AC	+ \$200

SPECIFICATIONS

	2222 B9 S1 Midback Thintex Task Stool	2222 B9 S2 Midback Thintex Extended Task Stool
Dimensions		
Overall Width	27"	27"
Overall Depth	27"	27"
Overall Height	8.5" (B0/B20/B21) 36.5" (B8)	43" (B0/B20/B21) 41" (B8)
Seat Width	20"	20"
Seat Depth	17.5"	17.5"
Seat Height	22"-30"	26"-36"
Back Width	19"	19"
Back Height	18.75"	18.75"
Weight Armless	28.5 lb	29.5 lb
Weight With Arms	34.5 lb	35.5 lb
Materials		
COM	1 yd	1 yd
COL	17 sq ft	17 sq ft
Weight and Capacity		
Weight Capacity Warranty	300 lb	300 lb

Black base (B0). White base (B20). Fog base (B21). Brushed aluminum base (B8).



Chairs and Stools

MULTIPURPOSE | SIDE | GUEST | BARIATRIC
COUNTER STOOL | BAR STOOL

Statement of Line

MULTIPURPOSE | SIDE | GUEST | BARIATRIC
COUNTER STOOL | BAR STOOL

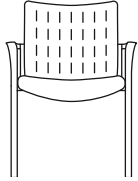

Achieve
4-Leg Multipurpose Chair
91 USPage 212

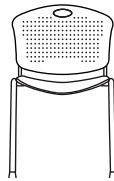

Anytime
4-Leg Multipurpose Chair
93.....Page 215

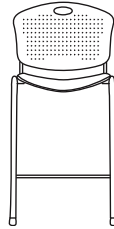

Anytime
4-Leg Bar Stool
93 S2Page 215



Baja
Wire Rod Multipurpose Chair
1171 FT2 BK4Page 219

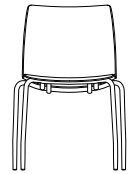

Baja
4-Leg Multipurpose Chair
1171 FT1 BK4Page 219

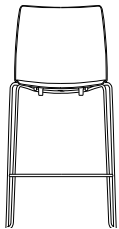

Baja
Wire Bar Stool
1171 FT2 S2 BK4...Page 219

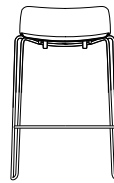

Baja
Low Back Wire Rod Bar
1171 FT2 S2 BK3...Page 219



Cora
Guest Chair
1191 SW19 Page 224

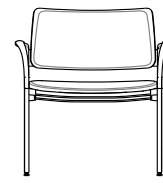

Cora
Midsize Chair
1191 SW26Page 224

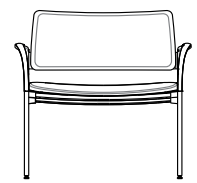

Cora
Bariatric Chair
1191 SW30Page 224

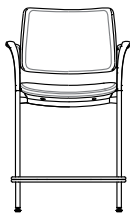

Cora
Counter Stool
1191 SW19 S9.....Page 224

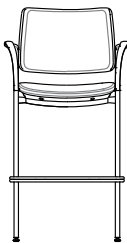

Cora
Bar Stool
1191 SW19 S2.....Page 224

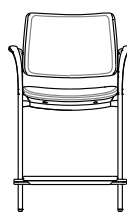

Cora
Easy Access Hip Chair
1191 SW19 S4.....Page 224

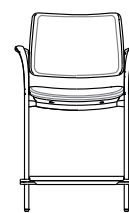

Cora
Easy Access Hip Chair
1191 SW19 S4.....Page 224

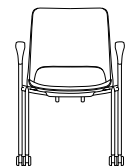

Flyte
Stacking Nester
1651 FT4.....Page 230

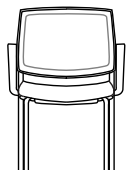

Focus Side Mesh
4-Leg Chair
5651/5652Page 234

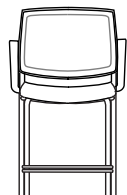

Focus Side Mesh
4-Leg Counter Stool
5651/5652 S9Page 234

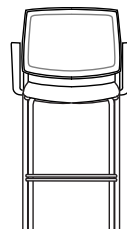

Focus Side Mesh
4-Leg Bar Stool
5651/5652 S2Page 234

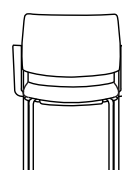

Focus Side Upholstered
4-Leg Side Chair
5651/5652Page 234

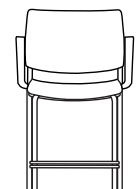

Focus Side Upholstered
4-Leg Counter Stool
5651/5652 S9Page 234

Statement of Line

MULTIPURPOSE | SIDE | GUEST | BARIATRIC
COUNTER STOOL | BAR STOOL

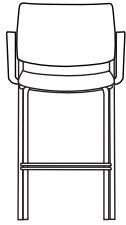

Focus Side Upholstered
4-Leg Bar Stool
5651/5652 S2Page 234

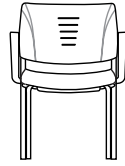

Focus Side Wood
4-Leg Side Chair
5651/5652Page 234

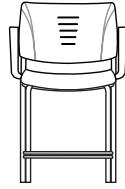

Focus Side Wood
4-Leg Counter Stool
5651/5652 S9Page 234

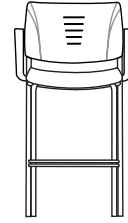

Focus Side Wood
4-Leg Bar Stool
5651/5652 S2Page 234

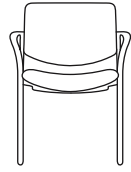

Freelance
4-Leg Multipurpose Chair
521XPage 239

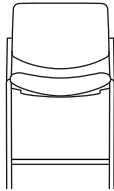

Freelance
4-Leg Counter Stool
5214 S9Page 239

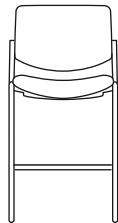

Freelance
4-Leg Bar Stool
5214 S2Page 239



Freelance
30" Bariatric Chair
5314Page 245

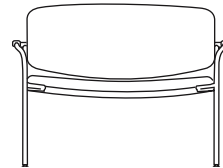

Freelance
42" Bariatric Chair
5414Page 245

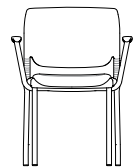

InFlex
4-Leg Multipurpose Chair
971Page 248

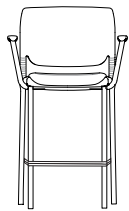

InFlex
4-Leg Counter Stool
971 S9Page 248

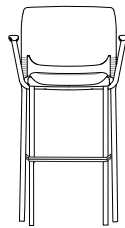

InFlex
4-Leg Bar Stool
971 S2Page 248

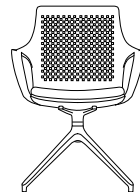

Ioniq
4-Star Guest Chair
1152 FT5Page 252

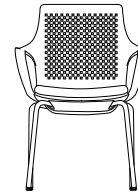

Ioniq
4-Leg Multipurpose Chair
1151 FT1Page 254

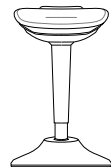

Kickstand
Stool
1167Page 256

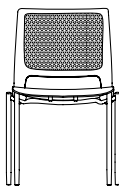

Lumin
4-Leg Multipurpose Chair
1011 FT1Page 258

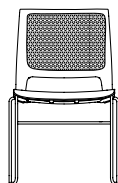

Lumin
Wire Rod Multipurpose Chair
1011 FT2Page 258

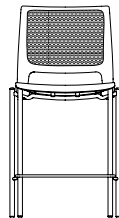

Lumin
4-Leg Counter Stool
1011 FT1 S9Page 258

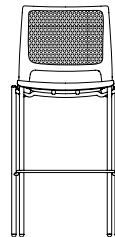

Lumin
4-Leg Bar Stool
1011 FT1 S2Page 258

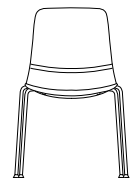

Mika
4-Leg Multipurpose Chair
1101 FT1 S9Page 263

Statement of Line

MULTIPURPOSE | SIDE | GUEST | BARIATRIC
COUNTER STOOL | BAR STOOL

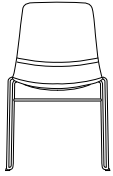

Mika
Wire Rod Multipurpose Chair
1101 FT1 S9Page 263

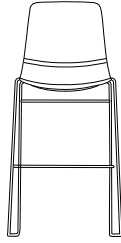

Mika
Wire Rod Bar Stool
1101 FT1 S9Page 263



Movi
Nester Chair
1061 FT4 MBPage 267



Movi
Nester Chair
1061 FT4 UBPage 267

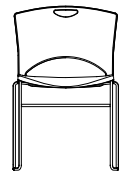

OnCall
Wire Rod Multipurpose Chair
90Page 271

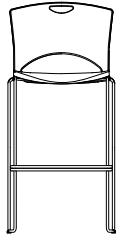

OnCall
Wire Rod Bar Stool
90 S2Page 271

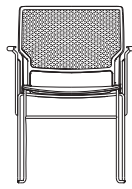

Orbix
Wire Rod Chair
1131 FT2Page 275

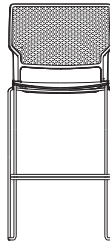

Orbix
Wire Rod Bar Stool
1131 FT2 S2Page 275

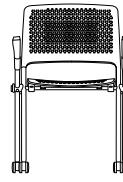

Qwiz
Nester Chair
1141 FT4Page 279

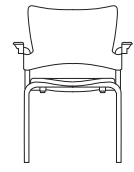

Relay
Multipurpose Chair
94SPage 283

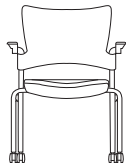

Relay
Nester Chair
94XB/94XSPage 283

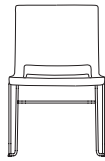

Rio
Wire Rod Multipurpose Chair
1051 FT2Page 289



Rio
4-Leg Multipurpose Chair
1051 FT1Page 289

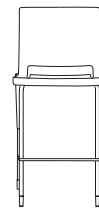

Rio
4-Leg Counter Stool
1051 FT1 S9Page 289

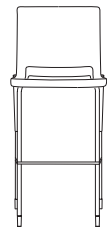

Rio
4-Leg Bar Stool
1051 FT1 S2Page 289

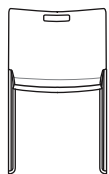

Rowdy
Wire Rod Chair
92 SB/92 SCPage 293

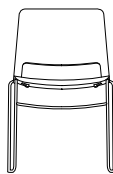

Sprout
Wire Rod Chair
1181 FT2Page 296

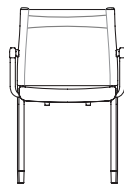

Wit Side Mesh
4-Leg Side Chair
2221 FT1 MBPage 299

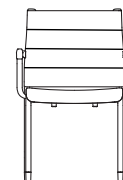

Wit Side Thintex
4-Leg Side Chair
2221 FT1 TXBPage 302

Achieve

MULTIPURPOSE CHAIR

Own the space.

Achieve upholstered and plastic side chairs provide the feel of a large chair but with a clean and slender profile. The concave back and contoured seat match the natural curves of the human body, combining comfortable ergonomic support with eye-catching contemporary design. The plastic model's perforated back allows the body to breathe, keeping the user cool while seated.



Good
Featured with SitOnIt Seating's Venice — Gold Dusk

EFFECTIVE NOVEMBER 4, 2024

Featured Models

GOOD :: \$564

4-leg chair, plastic back and upholstered seat, armless, standard multi-surface glides, grade 1 textile

BETTER :: \$678

4-leg chair, upholstered seat and back, fixed loop arms, standard multi-surface glides, grade 1 textile

BEST :: \$718

4-leg chair, upholstered seat and back, fixed loop arms, carpet casters, grade 1 textile

Features

- Clean and contemporary, ideal for guest and lobby areas, meeting and conference rooms
- Fully upholstered or plastic back with upholstered seat
- Generously proportioned contoured design follows the curves of the body
- Waterfall seat promotes proper leg circulation
- Wall-saver anti-tip frame design
- Additional seat foam option
- 250 lb weight capacity warranty



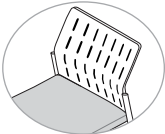
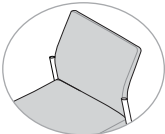

1. Back

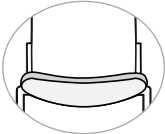
Back and Seat Style	Code	Price	
Black Plastic Back, Upholstered Seat	91 US	\$613	
Upholstered Seat and Back	91 UP	\$678	

2. Seat

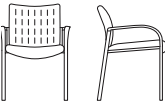
Seat Options	Code	Price	
1" Additional Foam	F1	+ \$36	

3. Frame

Frame Finish and Style	Code	Price	
Black	FB	+ \$0	
Silver	FS	+ \$0	
Black With Black Carpet Casters	FCB	+ \$40	
Silver With Black Carpet Casters	FCS	+ \$40	

MULTIPURPOSE CHAIR

4. Base

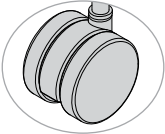
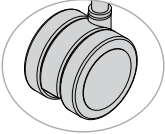
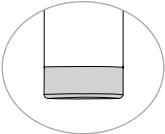
Casters or Glides	Code	Price	
Casters			
Carpet Casters	C13	+ \$0	
Hard Floor and Carpet Casters	C12	+ \$40	
Glides			
Standard Multi-Surface Glides	G6	+ \$0	

Please use caution when stacking models with casters to prevent frame damage. SitOnIt Seating does not warrant scratched frames.

5. Arms

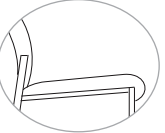
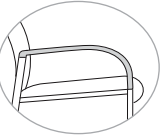
Arm Style	Code	Price	
Armless	A0	- \$49	
Fixed Loop	A40	+ \$0	

6. Miscellaneous

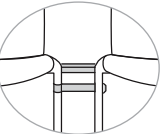
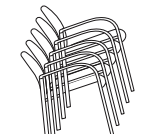
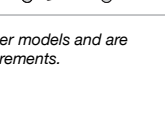
Accessories	Code	Price	
Ganging Bracket for Armless Models	GG4	+ \$30	
Ganging Bracket for Models With Arms	GA4	+ \$30	
Stacking Cart	14-Cart	+ \$399	

Ganging brackets and stacking carts are not intended for use with caster models and are compatible with glides only. See page 630 for additional stacking requirements.

7. Material

Protection	Code	Price
Fire Retardancy		
CAL 133, Fabric, Quantities 1–49	133F	+ \$99
CAL 133, Fabric, Quantities 50+	133F5	+ \$55
CAL 133, Leather, Any Quantity	133L	+ \$119
Textile	Code	Price
Seat Textile (For US)		
Fabric/Vinyl Grade 1	FG1/VG1	+ \$0
COM	COM	+ \$24
Fabric/Vinyl Grade 2	FG2/VG2	+ \$24
Fabric/Vinyl Grade 3	FG3/VG3	+ \$45
Fabric/Vinyl Grade 4	FG4/VG4	+ \$77
Fabric/Vinyl Grade 5	FG5/VG5	+ \$116
Fabric/Vinyl Grade 6	FG6/VG6	+ \$159
Fabric/Vinyl Grade 7	FG7/VG7	+ \$200
Leather Grade 1	LG1	+ \$140
COL	COL	+ \$200
Leather Grade 2	LG2	+ \$200
Leather Grade 3	LG3	+ \$280
Seat and Back (For UP)		
Fabric/Vinyl Grade 1	FG1/VG1	+ \$0
COM	COM	+ \$36
Fabric/Vinyl Grade 2	FG2/VG2	+ \$36
Fabric/Vinyl Grade 3	FG3/VG3	+ \$74
Fabric/Vinyl Grade 4	FG4/VG4	+ \$121
Fabric/Vinyl Grade 5	FG5/VG5	+ \$174
Fabric/Vinyl Grade 6	FG6/VG6	+ \$235
Fabric/Vinyl Grade 7	FG7/VG7	+ \$296
Leather Grade 1	LG1	+ \$260
COL	COL	+ \$320
Leather Grade 2	LG2	+ \$320
Leather Grade 3	LG3	+ \$400

Please reference the [Textile Reference Guide](#) for pricing on fabric over grade 7 and leather over grade 3. Additional CAL 133 information can be found on [page 15](#).

Please reference the [Fabric information](#) found on [page 17](#) for pricing on multi-upholstery.

MULTIPURPOSE CHAIR

8. Packaging

Packaging	Code	Price
Fully Assembled In a Carton	AC3	+ \$0
Fully Assembled In a Carton, Individually Packaged	AC1	+ \$20

SPECIFICATIONS

Model:	91 Multipurpose Chair
Dimensions	
Overall Width Armless	22"
Overall Width With Arms	25"
Overall Depth	24"
Overall Height	33.5"
Seat Width	19.5"
Seat Depth	19"
Seat Height	18"
Back Width	18"
Back Height	16"
Materials	
COM	1 yd (US), 1.75 yd (UP)
COL	17 sq ft (US), 30 sq ft (UP)
Stacking	
Max Cart Stacking	5
Max Floor Stacking	4
Weight and Capacity	
Weight Armless	18 lb
Weight With Arms	21 lb
Weight Capacity Warranty	250 lb

Upholstered seat only (US). Upholstered seat and back (UP).

Anytime

MULTIPURPOSE CHAIR AND BAR STOOL

Grab and go. Anywhere.

The economical Anytime collection was designed for corporate, government and educational settings where flexibility and style are key requirements. The perforated plastic back provides ample ventilation and upholstered pads can be added for increased comfort. You can specify Anytime as fully upholstered or with an upholstered seat only. Frame colors are either black or silver. The pull handle ensures that the Anytime side chair is ready to go anytime and anywhere it is needed.



Good
Featured with a Navy shell

EFFECTIVE NOVEMBER 4, 2024

Featured Models

GOOD :: \$333

4-leg chair, all plastic, armless, standard multi-surface glides

BETTER :: \$398

4-leg chair, upholstered seat, plastic back, armless, standard multi-surface glides



BEST :: \$521

4-leg chair, upholstered seat and back, fixed arms, standard multi-surface glides

Features

- Fully upholstered, upholstered seat or plastic
- Three plastic colors
- Perforated shell provides ventilation
- Built-in pull handle
- Black or silver tubular frame
- Stacks six on the floor; eight on the optional cart
- 250 lb weight capacity warranty
- Complements Anytime light task chair and stool; see [page 53](#)

1. Back

Back and Seat Style	Code	Price	
Plastic	No Code	\$333	
Upholstered Seat Only	US	\$398	
Upholstered Seat and Back	UP	\$463	

2. Frame

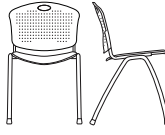
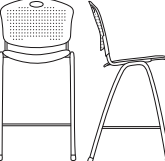
Frame Type	Code	Price	
4-Leg	93	+ \$0	
30" Bar Stool	93 S2	+ \$150	



Bar stools (S2) are available with glides only.

MULTIPURPOSE CHAIR AND BAR STOOL

2. Frame (Cont.)

Frame Finish	Code	Price	
Black	FB	+ \$0	
Black With Casters	FCB	+ \$40	
Silver	FS	+ \$0	
Silver With Casters	FCS	+ \$40	

3. Arms

Arm Style	Code	Price	
Armless	A0	+ \$0	
Fixed Loop Arms (Black)	A48	+ \$58	
Fixed Loop Arms (Silver)	A49	+ \$58	

4. Base

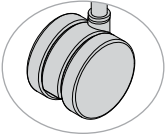
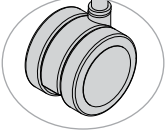
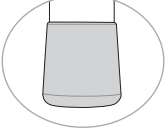
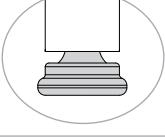
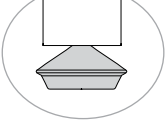
Casters or Glides	Code	Price	
Casters			
Carpet Casters	C13	+ \$0	
Hard Floor and Carpet Casters	C12	+ \$40	
Glides			
Standard Multi-Surface Glides	G7	+ \$0	
Floor Saver Glides	G15	+ \$20	
Steel Glides (Carpet Only)	G14	+ \$20	
Performance Multi-Surface Glides	GL2	+ \$20	

Casters not available with bar stool (S2). Do not stack chairs with casters.

5. Miscellaneous

Ganging	Code	Price	
---------	------	-------	--

Ganging Bracket for Armless Models

GG6

+ \$30

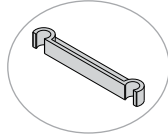

Ganging Bracket for Models With Arms

GA6

+ \$30

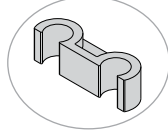

Stacking	Code	Price	
----------	------	-------	--

Stacking Cart

93-Cart

+ \$399



Ganging brackets and stacking carts are not available for caster models and are only available for chairs with glides.

Due to the nature of upholstery, stacking may cause impressions on the seat. SitOnIt Seating does not warrant the effects of stacking on upholstery.

See [page 630](#) for additional stacking requirements.



Best
Featured with a Slate frame and SitOnIt Seating's Dash — Sky

MULTIPURPOSE CHAIR AND BAR STOOL

6. Material

Protection	Code	Price	
------------	------	-------	--

Fire Retardancy

CAL 133, Fabric, Quantities 1–49 133F + \$99

CAL 133, Fabric, Quantities 50+ 133F5 + \$55

CAL 133, Plastic, Any Quantity 133P + \$45

Shell Color	Code	Price	
-------------	------	-------	--

Black SC1 + \$0

Navy SC5 + \$0

Slate SC8 + \$0

Textile	Code	Price	
---------	------	-------	--

Seat Only (For US)

Fabric/Vinyl Grade 1 FG1/VG1 + \$0

COM COM + \$24

Fabric/Vinyl Grade 2 FG2/VG2 + \$24

Fabric/Vinyl Grade 3 FG3/VG3 + \$45

Fabric/Vinyl Grade 4 FG4/VG4 + \$77

Fabric/Vinyl Grade 5 FG5/VG5 + \$116

Fabric/Vinyl Grade 6 FG6/VG6 + \$159

Fabric/Vinyl Grade 7 FG7/VG7 + \$200

Seat and Back (For UP)

Fabric/Vinyl Grade 1 FG1/VG1 + \$0

COM COM + \$36

Fabric/Vinyl Grade 2 FG2/VG2 + \$36

Fabric/Vinyl Grade 3 FG3/VG3 + \$74

Fabric/Vinyl Grade 4 FG4/VG4 + \$121

Fabric/Vinyl Grade 5 FG5/VG5 + \$174

Fabric/Vinyl Grade 6 FG6/VG6 + \$235

Fabric/Vinyl Grade 7 FG7/VG7 + \$296

Please reference the [Textile Reference Guide](#) for pricing on fabric over grade 7. Additional CAL 133 information can be found on [page 15](#).

Please reference the Fabric information found on [page 17](#) for pricing on multi-upholstery.

7. Packaging

Packaging	Code	Price	
-----------	------	-------	--

Fully Assembled In a Carton AC + \$0

Fully Assembled In a Carton, Individually Packaged AC1 + \$20

EFFECTIVE NOVEMBER 4, 2024 | GSA SIN #: 33721

SPECIFICATIONS

Model:	93 4-Leg Multipurpose	93 S2 30" Bar Stool
Dimensions		
Overall Width Armless	21.5"	22"
Overall Width With Arms	26.5"	27"
Overall Depth	22"	22"
Overall Height	32.5"	44"
Seat Width	19"	19"
Seat Depth	18"	18"
Seat Height	18"	30.5"
Back Width	21.5"	21.5"
Back Height	14.5"	14.5"
Materials		
COM	0.8 yd (US) 1 yd (UP)	0.8 yd (US) 1 yd (UP)
Stacking		
Max Cart Stacking	8	N/A
Max Floor Stacking	6	N/A
Weight and Capacity		
Weight Armless	14 lb	21.5 lb
Weight With Arms	18 lb	25.5 lb
Weight Capacity Warranty	250 lb	250 lb

Upholstered seat (US). Upholstered seat and back (UP).



Better
Featured with a Black shell and
SitOnIt Seating's Huntington Tropical

Baja

MULTIPURPOSE CHAIR AND BAR STOOL

Immerse in possibilities.

Let's come together. When you want to feel the room and fill the room, there's Baja. Its comfort, customization, features and function will stand out— all while blending in – and echo the vibe of any space with subtle sophistication. Discover what's possible when you're surrounded by cohesive design.



Good
Featured with a Navy shell

EFFECTIVE NOVEMBER 4, 2024

Featured Models

GOOD :: \$395

All plastic, 4-leg, armless, standard multi-surface glides

BETTER :: \$460

Plastic back and upholstered seat, 4-leg, armless, standard multi-surface glides, grade 1 textile



BEST :: \$583

Fully upholstered, 4-leg, fixed arms, standard multi-surface glides, grade 1 textile

Features

- Scale and sculpture offer a roomier, more comfortable sit
- Seamless design and broad collection create cohesion in any space
- Residential-inspired features and options, including standard and low-back stools
- Responsive, single-piece shell offers 18 degrees of backrest flex
- Bases include wire rod, wire rod stool and 4-leg with casters or glides
- Choose from 14 shell colors, three arm pad colors, two wire rod and three 4-leg finishes
- Stackable on the floor or on a cart for quick clean-up and easy storage
- 300 lb weight capacity warranty





1. Frame

Frame Type	Code	Price	
4-Leg	1171 FT1	\$395	
Wire Rod	1171 FT2	\$372	
30" Wire Rod Bar Stool	1171 FT2 S2	\$522	

Frame Finish	Code	Price	
4-Leg (FT1) Only			
Black	FC1	+ \$0	
Silver	FC2	+ \$0	
White	FC12	+ \$0	
Wire Rod (FT2) Only			
Black	FC1	+ \$0	
Chrome	FC15	+ \$0	

MULTIPURPOSE CHAIR AND BAR STOOL

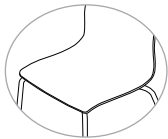
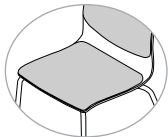
2. Back and Seat

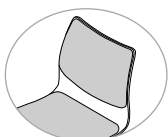

Back Size	Code	Price	
Standard Back	BK4	+ \$0	
Low Back	BK3	+ \$0	
Seat Style	Code	Price	
Plastic Seat	PS	+ \$0	
Upholstered Seat	US	+ \$65	
Back Style	Code	Price	
Plastic Back	PB	+ \$0	
Upholstered Back	UB	+ \$65	

Low back option available for bar stool (S2) only.

Upholstered back (UB) option available only with upholstered seat (US) and is not compatible with the low back (BK3) option.

Due to the nature of upholstery, stacking may cause impressions on the seat. SitOnIt Seating does not warrant the effects of stacking on upholstery.

3. Arms

Arm Style	Code	Price	
Armless	AR0	+ \$0	
Fixed Arms	AR1	+ \$58	

Fixed arms available on 4-leg chair (FT1) only. Arm finish matches frame finish. Arm pads are black on the black (FC1) frame or fog on the silver (FC2) and white on the white (FC12) frames.

4. Base

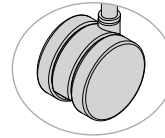
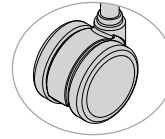
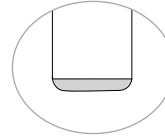
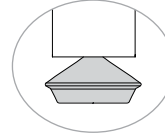
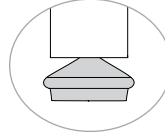
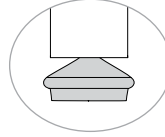
Casters or Glides	Code	Price	
Casters (For 4-Leg Chair FT1 Only)			
Carpet Casters	CS5	+ \$40	
Hard Floor and Carpet Casters	CS6	+ \$80	
Glides (For 4-Leg Chair FT1 Only)			
Standard Multi-Surface Glides	GL1	+ \$0	
Performance Multi-Surface Glides	GL2	+ \$20	
Floor Saver Glides	GL3	+ \$20	
Steel Glides (Carpet Only)	GL4	+ \$20	

MULTIPURPOSE CHAIR AND BAR STOOL

4. Base (Cont.)

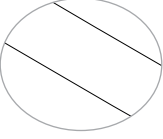
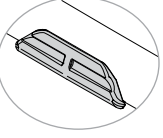
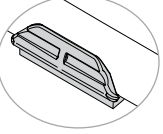

Casters or Glides	Code	Price	
Glides (For Wire Rod FT2 Only)			
No Glides	G0	+ \$0	
Clear Glides	CGR	+ \$9	
Clear Glides With Felt	CGRF	+ \$27	

Casters are black on the black (FC1) frame or fog on the silver (FC2) and white on the white (FC12) frames.



Best
Featured with an Arctic shell
and SitOnIt Seating's Dash — Cloud

5. Miscellaneous

Accessories	Code	Price	
Ganging Bracket	GG	+ \$30	
Stacking Cart	CART	+ \$399	

Ganging Brackets (GG) available on armless (AR0) models only.

Stacking Carts require assembly.

Please use caution when stacking models with casters to prevent frames damage. SitOnIt Seating does not warrant scratched frames.

See [page 630](#) for additional stacking requirements.



Better
Featured with a Sterling shell
and SitOnIt Seating's Dash — Navy

MULTIPURPOSE CHAIR AND BAR STOOL

6. Material

Shell Color	Code	Price	
Black	SC1	+ \$0	
Chocolate	SC4	+ \$0	
Latte	SC20	+ \$0	
Navy	SC5	+ \$0	
Slate	SC8	+ \$0	
Apple	SC24	+ \$0	
Arctic	SC21	+ \$0	
Bisque	SC7	+ \$0	
Lagoon	SC15	+ \$0	
Lemon	SC25	+ \$0	
Pacific	SC22	+ \$0	
Red	SC19	+ \$0	
Sterling	SC18	+ \$0	
Tangerine	SC23	+ \$0	

Textile	Code	Price	
Seat Only (US)			
Fabric/Vinyl Grade 1	FG1/VG1	+ \$0	
COM	COM	+ \$24	
Fabric/Vinyl Grade 2	FG2/VG2	+ \$24	
Fabric/Vinyl Grade 3	FG3/VG3	+ \$45	
Fabric/Vinyl Grade 4	FG4/VG4	+ \$77	
Fabric/Vinyl Grade 5	FG5/VG5	+ \$116	
Fabric/Vinyl Grade 6	FG6/VG6	+ \$159	
Fabric/Vinyl Grade 7	FG7/VG7	+ \$200	
Seat and Back (US + UB)			
Fabric/Vinyl Grade 1	FG1/VG1	+ \$0	
COM	COM	+ \$36	
Fabric/Vinyl Grade 2	FG2/VG2	+ \$36	
Fabric/Vinyl Grade 3	FG3/VG3	+ \$74	
Fabric/Vinyl Grade 4	FG4/VG4	+ \$121	
Fabric/Vinyl Grade 5	FG5/VG5	+ \$174	
Fabric/Vinyl Grade 6	FG6/VG6	+ \$235	
Fabric/Vinyl Grade 7	FG7/VG7	+ \$296	

Please reference the [Textile Reference Guide](#) for pricing on fabric over grade 7.

7. Packaging

Packaging	Code	Price	
Fully Assembled In a Carton	AC	+ \$0	
Fully Assembled In a Carton, Individually Packaged	AC1	+ \$20	

CHAIR SPECIFICATIONS

Model:	1171 FT1 4-Leg Chair	1171 FT2 Wire Rod Chair
Dimensions		
Overall Width With Arms	27"	N/A
Overall Width Armless	22.25"	22"
Overall Depth	21.5"	22.5"
Overall Height	32.5"	32"
Seat Width	18.5"	18.5"
Seat Depth	18"	18"
Seat Height	18"	17.5"
Back Width	18.25"	18.25"
Back Height	15.75"	16.5"
Materials		
COM	0.75 yd (US) 1 yd (UB)	0.75 yd (US) 1 yd (UB)
Stacking		
Max Cart Stacking Armless	10 (PS) 8 (US/UB)	6 (PS) 4 (US/UB)
Max Cart Stacking With Arms	10 (PS) 8 (US/UB)	N/A
Max Floor Stacking Armless	6 (PS) 4 (US/UB)	6
Max Floor Stacking With Arms	6 (PS) 4 (US/UB)	N/A
Weight and Capacity		
Weight With Arms	18 lb	N/A
Weight Armless	16 lb	15 lb
Weight Capacity Warranty	300 lb	300 lb

Plastic seat (PS). Upholstered seat (US). Upholstered back (UB).

MULTIPURPOSE CHAIR AND BAR STOOL

STOOL SPECIFICATIONS

Model:	1171 FT2 S2 30" Wire Rod Bar Stool
Dimensions	
Overall Width Armless	22"
Overall Depth	22.5"
Overall Height	45" (BK4) 35.25" (BK3)
Seat Width	18.5"
Seat Depth	18"
Seat Height	29.5"
Back Width	18.25"
Back Height	16.5" (BK4) 7" (BK3)
Materials	
COM	0.75 yd (US) 1 yd (UB)
Stacking	
Floor Stacking	4
Weight and Capacity	
Weight Armless	22 lb (BK4) 20 lb (BK3)
Weight Capacity	300 lb

Upholstered seat (US). Upholstered back (UB). Standard back (BK4). Low back (BK3).

Cora

MULTIPURPOSE CHAIR, BARIATRIC,
COUNTER STOOL AND BAR STOOL

Ability for any facility.

With expert insights from Certified Healthcare Interior Designers® (CHID), Cora was designed to withstand the high demands of our modern spaces. It's a research-driven solution engineered for cleanability, reliability and durability—while ensuring central comfort and cohesion across every model.



Best
Featured with SitOnIt Seating's
Spice — Electric Blue

EFFECTIVE NOVEMBER 4, 2024

Featured Models

GUEST :: \$472

Guest chair, upholstered back, upholstered seat, fixed arms, standard multi-surface glides, grade 1 textile

MIDSIZE :: \$622

Midsized chair, upholstered back, upholstered seat, fixed arms, performance multi-surface glides, grade 1 textile

BARIATRIC :: \$875

Bariatric chair, upholstered back, upholstered seat, fixed arms, performance multi-surface glides, grade 1 textile

MULTIPURPOSE CHAIR, BARIATRIC, COUNTER STOOL AND BAR STOOL

Features

- Designed with expert insight from Certified Healthcare Interior Designers®
- A high-performing solution for any industry, including corporate, healthcare, education and more
- Easy to maintain with clean-out space and field replaceable components, including seat and back
- Wall-saver frame keeps everything fresh, preventing scuffs and marks
- Looped arms are streamlined yet wide enough to sit down and get up with ease
- Bleach cleanable, multi-upholstery and ballistic nylon options
- Edge-to-edge underseat cover provides full coverage on the guest model for enhanced stacking (four on floor; six on cart)
- Meets Healthier Hospitals Safer Chemicals Challenge 2.3, BIFMA LEVEL, GreenGuard Gold, and BIFMA X5.1 to X5.41
- Curated collection with an array of weight capacity warranties—guest model, easy access hip chair, counter stool and bar stool (500 lb), midsize model (600 lb), and bariatric model (750 lb)

1. Frame

Frame Type	Code	Price	
Guest (500 lb Capacity)	1191 SW19	\$472	
Midsize (600 lb Capacity)	1191 SW26	\$622	
Bariatric (700 lb Capacity)	1191 SW30	\$875	
Counter Stool (500 lb Capacity)	1191 SW19 S9	\$622	
Bar Stool (500 lb Capacity)	1191 SW19 S2	\$622	
Easy Access Hip Chair (500 lb Capacity)	1191 SW19 S4	\$787	
Frame Finish	Code	Price	
Black	FC1	+ \$0	
Silver	FC2	+ \$0	



See the Super Duty Guide on page 626 for additional high weight capacity models.

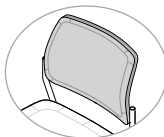
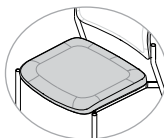

2. Back and Seat

Back Style	Code	Price	
Upholstered Back	UB	+ \$0	
Seat Style	Code	Price	
Upholstered Seat	US	+ \$0	

MULTIPURPOSE CHAIR, BARIATRIC, COUNTER STOOL AND BAR STOOL

3. Arms

Arm Style	Code	Price	
Armless	AR0	- \$49	
Fixed	AR1	+ \$0	

Arm Cap Finish	Code	Price	
Black	AC3	+ \$0	
Fog	AC6	+ \$0	

Armless (AR0) option is available on guest (SW19) chairs, counter (SW19 S9) and bar (SW19 S2) stools only.

4. Base

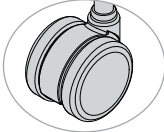
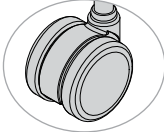
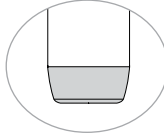
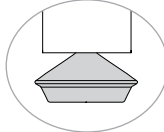
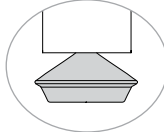
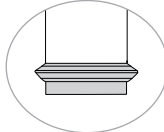
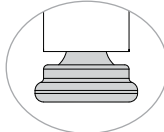

Casters or Glides	Code	Price	
Casters			
Carpet Casters	CS5	+ \$40	
Hard Floor and Carpet Casters	CS6	+ \$80	
Glides			
Standard Multi-Surface Glides	GL1	+ \$0	
Performance Multi-Surface Glides for Guest Chair	GL2	+ \$17	
Performance Multi-Surface Glides for Midsize or Bariatric Chair	GL2	+ \$0	
Floor Saver Glides	GL3	+ \$17	
Steel Glides (Carpet Only)	GL4	+ \$17	

Standard multi-surface glides (GL1) are not available on midsize (SW26) or bariatric (SW30) chairs. Performance multi-surface glides (GL2) are standard on midsize (SW26) or bariatric (SW30) chairs. Caster color coordinates with frame color. Casters are available on guest (SW19) models only.

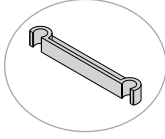
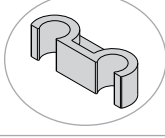

*Bariatric
Featured with SitOnIt Seating's
Huntington – Night*

5. Miscellaneous

Accessories	Code	Price	
Ganging Bracket (Fixed Arms Only)	GA	+ \$30	
Ganging Bracket (Armless Only)	GG	+ \$30	
Stacking Cart	CART	+ \$399	

Stacking cart is only compatible with guest (SW19) models and is not compatible with casters (CS5/CS6). See page 630 for additional stacking requirements.

6. Material

Cleaning	Code	Price	
Moisture Barrier			Guest Midsize/ Bariatric
Seat Only	UM2	+ \$35	+ \$35
Ballistic Nylon	Code	Price	
Ballistic Nylon Back	BN	+ \$0	+ \$0
Fully Upholstered	Code	Price	
Seat and Back Upholstery			Guest/Hip Chair/Stools Midsize/ Bariatric
Fabric/Vinyl Grade 1	FG1/VG1	+ \$0	+ \$0
COM	COM	+ \$36	+ \$40
Fabric/Vinyl Grade 2	FG2/VG2	+ \$36	+ \$40
Fabric/Vinyl Grade 3	FG3/VG3	+ \$74	+ \$84
Fabric/Vinyl Grade 4	FG4/VG4	+ \$121	+ \$156
Fabric/Vinyl Grade 5	FG5/VG5	+ \$174	+ \$228
Fabric/Vinyl Grade 6	FG6/VG6	+ \$235	+ \$304
Fabric/Vinyl Grade 7	FG7/VG7	+ \$296	+ \$378
Leather Grade 1	LG1	+ \$140	+ \$240
COL	COL	+ \$200	+ \$540
Leather Grade 2	LG2	+ \$200	+ \$540
Leather Grade 3	LG3	+ \$280	+ \$820

MULTIPURPOSE CHAIR, BARIATRIC,
COUNTER STOOL AND BAR STOOL

6. Material (Cont)

Multi-Upholstery	Code	Price	
Upcharge			Guest/Hip Chair/Stools Midsize/ Bariatric
Multi-Upholstery Upcharge	UMU	+ \$58	+ \$58
Seat Upholstery Only			Guest/Hip Chair/Stools Midsize/ Bariatric
Fabric/Vinyl Grade 1	FG1/VG1	+ \$0	+ \$0
COM	COM	+ \$24	+ \$26
Fabric/Vinyl Grade 2	FG2/VG2	+ \$24	+ \$26
Fabric/Vinyl Grade 3	FG3/VG3	+ \$45	+ \$60
Fabric/Vinyl Grade 4	FG4/VG4	+ \$77	+ \$116
Fabric/Vinyl Grade 5	FG5/VG5	+ \$116	+ \$172
Fabric/Vinyl Grade 6	FG6/VG6	+ \$159	+ \$213
Fabric/Vinyl Grade 7	FG7/VG7	+ \$200	+ \$254
Leather Grade 1	LG1	+ \$100	+ \$160
COL	COL	+ \$145	+ \$360
Leather Grade 2	LG2	+ \$145	+ \$360
Leather Grade 3	LG3	+ \$200	+ \$550

Ballistic nylon back (NBN) is not available with multi-upholstery (UMU).

Back Upholstery Only		Price	Guest/Hip Chair/Stools Midsize/ Bariatric
Fabric/Vinyl Grade 1	FG1/VG1	+ \$0	+ \$0
COM	COM	+ \$18	+ \$22
Fabric/Vinyl Grade 2	FG2/VG2	+ \$18	+ \$22
Fabric/Vinyl Grade 3	FG3/VG3	+ \$39	+ \$45
Fabric/Vinyl Grade 4	FG4/VG4	+ \$63	+ \$77
Fabric/Vinyl Grade 5	FG5/VG5	+ \$91	+ \$116
Fabric/Vinyl Grade 6	FG6/VG6	+ \$123	+ \$159
Fabric/Vinyl Grade 7	FG7/VG7	+ \$154	+ \$200
Leather Grade 1	LG1	+ \$70	+ \$130
COL	COL	+ \$100	+ \$295
Leather Grade 2	LG2	+ \$100	+ \$295
Leather Grade 3	LG3	+ \$140	+ \$450

If different fabrics are selected for the seat and back, add the multi-upholstery upcharge as well, even if the fabrics are the same grade.

Please reference the [Textile Reference Guide](#) for pricing on fabric over grade 7 and leather over grade 3. Additional CAL 133 information can be found on [page 15](#).

7. Packaging

Subhead	Code	Price	
Fully Assembled In a Carton	AC	+ \$0	

SPECIFICATIONS

Model: 1191	SW19 Guest Chair	SW26 Midsize Chair	SW30 Bariatric Chair
Dimensions			
Overall Width With Arms	24.75"	31.25"	35.5"
Overall Width Armless	21.25"	N/A	N/A
Overall Depth	23"	23"	23"
Overall Height	33.75"	33.75"	33.75"
Seat Width	18.75"	25.75"	29.5"
Seat Depth	17.5"	17.5"	17.5"
Seat Height	18.25"	18.25"	18.25"
Back Width	19"	27.5"	30"
Back Height	15.75"	15.75"	15.75"
Materials			
COM (Back)	0.75 yd	0.95 yd	1.25 yd
COM (Seat)	0.9 yd	1 yd	1.25 yd
COM (Seat and Back)	1.25 yd	1.75 yd	2 yd
COL (Back)	12 sq ft	15 sq ft	18 sq ft
COL (Seat)	14 sq ft	17 sq ft	21 sq ft
COL (Seat and Back)	21 sq ft	27 sq ft	30 sq ft
Stacking			
Max Cart Stacking	6	N/A	N/A
Max Floor Stacking	4	N/A	N/A
Weight and Capacity			
Weight With Arms	24.5 lb	37 lb	42.5 lb
Weight Armless	23 lb	N/A	N/A
Weight Capacity Warranty	500 lb	600 lb	750 lb

MULTIPURPOSE CHAIR, BARIATRIC, COUNTER STOOL AND BAR STOOL

SPECIFICATIONS

Model: 1191	SW19 S9 Counter Stool	SW19 S2 Bar Stool	SW19 S4 Easy Access Hip Chair
Dimensions			
Overall Width With Arms	24.75"	24.75"	24.75"
Overall Width Armless	21.25"	21.25"	N/A
Overall Depth	23"	23"	23.5"
Overall Height	39.5"	45.5"	39.5"
Seat Width	18.75"	18.75"	18.75"
Seat Depth	18.75"	18.75"	18.75"
Seat Height	24"	30"	24"
Back Width	19"	19"	19"
Back Height	15.75"	15.75"	15.75"
Materials			
COM (Back)	0.75 yd	0.75 yd	0.75 yd
COM (Seat)	0.9 yd	0.9 yd	0.9 yd
COM (Seat and Back)	1.25 yd	1.25 yd	1.25 yd
COL (Back)	12 sq ft	12 sq ft	12 sq ft
COL (Seat)	14 sq ft	14 sq ft	14 sq ft
COL (Seat and Back)	21 sq ft	21 sq ft	21 sq ft
Stacking			
Max Cart Stacking	N/A	N/A	N/A
Max Floor Stacking	N/A	N/A	N/A
Weight and Capacity			
Weight With Arms	35 lb	36 lb	38 lb
Weight Armless	33.5 lb	34.5 lb	N/A
Weight Capacity Warranty	500 lb	500 lb	500 lb



EFFECTIVE
NOVEMBER 4, 2024

REPLACEMENT SEATING PARTS

Replacement Parts: Seats

Seat Size	Code	Price	
Guest/Hip Chair/Counter Stool/Bar Stool Seat	SEAT	\$70	
Midback Seat	SEAT	\$85	
Bariatric Seat	SEAT	\$120	
Multi-Upholstery	Code	Price	
Seat Upholstery Only		Guest/Hip Chair/Stools	Midsize/Bariatric
Fabric/Vinyl Grade 1	FG1/VG1	+ \$0	+ \$0
COM	COM	+ \$24	+ \$28
Fabric/Vinyl Grade 2	FG2/VG2	+ \$24	+ \$28
Fabric/Vinyl Grade 3	FG3/VG3	+ \$45	+ \$60
Fabric/Vinyl Grade 4	FG4/VG4	+ \$77	+ \$116
Fabric/Vinyl Grade 5	FG5/VG5	+ \$116	+ \$172
Fabric/Vinyl Grade 6	FG6/VG6	+ \$159	+ \$213
Fabric/Vinyl Grade 7	FG7/VG7	+ \$200	+ \$254
Leather Grade 1	LG1	+ \$100	+ \$160
COL	COL	+ \$145	+ \$360
Leather Grade 2	LG2	+ \$145	+ \$360
Leather Grade 3	LG3	+ \$200	+ \$550

Replacement Parts: Back

Seat Size	Code	Price	
Guest Back	BACK	\$90	
Midback Back	BACK	\$120	
Bariatric Back	BACK	\$160	
Multi-Upholstery	Code	Price	
Back Upholstery Only		Guest/Hip Chair/Stools	Midsize/Bariatric
Fabric/Vinyl Grade 1	FG1/VG1	+ \$0	+ \$0
COM	COM	+ \$20	+ \$24
Fabric/Vinyl Grade 2	FG2/VG2	+ \$20	+ \$24
Fabric/Vinyl Grade 3	FG3/VG3	+ \$39	+ \$45
Fabric/Vinyl Grade 4	FG4/VG4	+ \$63	+ \$77
Fabric/Vinyl Grade 5	FG5/VG5	+ \$91	+ \$116
Fabric/Vinyl Grade 6	FG6/VG6	+ \$123	+ \$159
Fabric/Vinyl Grade 7	FG7/VG7	+ \$154	+ \$200
Leather Grade 1	LG1	+ \$70	+ \$130
COL	COL	+ \$100	+ \$295
Leather Grade 2	LG2	+ \$100	+ \$295
Leather Grade 3	LG3	+ \$140	+ \$450

Flyte

STACKING NESTER CHAIR

Sit back. Nest forward.

As the only angled nester (that also stacks) out there, our innovative Flyte is truly a forward-leaning, space-saving solution. Chairs deploy easily and securely with a latch that locks the seat into position with a satisfying click. And the multiple mesh and upholstery options mean you can take Flyte anywhere.



*Mesh Back
Featured with Lemon mesh and SitOnIt
Seating's Venice — Golddust*

EFFECTIVE NOVEMBER 4, 2024

Featured Models

PLASTIC :: \$548

Plastic seat and back, armless, fog shell, black frame, carpet casters

MESH BACK :: \$636

Mesh back, upholstered seat, white shell, fog frame and base, fixed arms, carpet casters, grade 1 textile

UPHOLSTERED :: \$694

Upholstered back, upholstered seat, white shell, fog frame and base, fixed arms, carpet casters, grade 1 textile

Features

- Slim modern design fits any space—education, training, multipurpose and more
- Contoured seat and flexing back provide essential comfort
- Stacks up to four chairs and nests endlessly
- Handy latch securely locks the seat with a satisfying click
- Clean-out space and steel frame plus plastic shell and vinyl options make it ultra cleanable
- 12 breathable mesh colors; three plastic shell colors; two leg and arm colors
- 350 lb weight capacity warranty



Plastic Back
Featured with a Fog shell

STACKING NESTER CHAIR

1. Frame

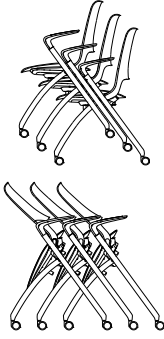
Frame Type	Code	Price	
Stacking/Nesting	1651 FT4	\$513	

2. Seat

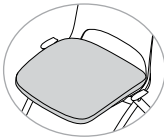

Seat Material	Code	Price	
Plastic Seat	PS	+ 0	
Upholstered Seat	US	+ \$58	

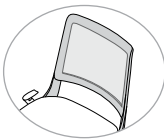
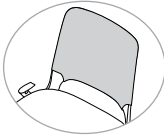
3. Back

Back Material	Code	Price	
Plastic Back	PB	+ 0	
Mesh Back	MB	+ \$33	
Upholstered Back	UB	+ \$58	

The upholstered back (UB) is only available with the upholstered seat (US).

4. Arms

Arm Style	Code	Price	
Armless	AR0	+ \$0	
Fixed Arms	AR1	+ \$30	

Arms (AR1) will match frame color.

5. Base

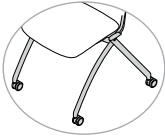
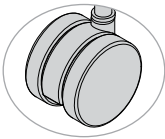
Frame and Caster Color	Code	Price	
Black	FC1	+ \$0	
Silver	FC2	+ \$0	
Caster Style	Code	Price	
Casters			
Carpet Casters	CS5	+ \$0	
Hard Floor and Carpet Casters	CS6	+ \$40	

6. Material

Shell Color	Code	Price	
Black	SC1	+ \$0	
Fog	SC27	+ \$35	
White	SC26	+ \$35	
Mesh Color (For MB Only)	Code	Price	
Apple	MC31	+ \$0	
Aqua	MC30	+ \$0	
Desert	MC22	+ \$0	
Electric Blue	MC24	+ \$0	
Fire	MC25	+ \$0	
Fog	MC23	+ \$0	
Grape	MC26	+ \$0	
Lemon	MC27	+ \$0	
Nickel	MC21	+ \$0	
Ocean	MC29	+ \$0	
Onyx	MC20	+ \$0	
Tangerine	MC28	+ \$0	

STACKING NESTER CHAIR

6. Material (Cont.)

Textile	Code	Price	
		Seat Only	Seat and Back
Fabric/Vinyl Grade 1	FG1/VG1	+ \$0	+ \$0
COM	COM	+ \$24	+ \$36
Fabric/Vinyl Grade 2	FG2/VG2	+ \$24	+ \$36
Fabric/Vinyl Grade 3	FG3/VG3	+ \$45	+ \$74
Fabric/Vinyl Grade 4	FG4/VG4	+ \$77	+ \$121
Fabric/Vinyl Grade 5	FG5/VG5	+ \$116	+ \$174
Fabric/Vinyl Grade 6	FG6/VG6	+ \$159	+ \$235
Fabric/Vinyl Grade 7	FG7/VG7	+ \$200	+ \$296

Stacking is not recommended when vinyl is specified.

Please reference the [Textile Reference Guide](#) for pricing on fabric over grade 7.

7. Packaging

Packaging	Code	Price	
Fully Assembled In a Carton	AC	+ \$0	
Assembled in Bag (Southern California Only)	AB	+ \$0	



Upholstered Back
Featured with SitOnIt Seating's
Sugar — Electric Blue

EFFECTIVE NOVEMBER 4, 2024 | GSA SIN #: 33721

SPECIFICATIONS

Model:	1651 FT4 Stacker/Nester Chair
Dimensions	
Overall Width With Arms	23.75"
Overall Width Armless	23"
Overall Depth	23.85"
Overall Height	34.5"
Seat Width	18"
Seat Depth	16.75"
Seat Height	18"
Back Width	17.75"
Back Height	19.5"
Stacking	
Floor Stacking	3 (PS), 4 (US)
Materials	
COM	0.75 yd (US), 1.25 (US+UB)
Weight and Capacity	
Weight With Arms	20 lb
Weight Armless	19 lb
Weight Capacity Warranty	350 lb

Upholstered seat (US). Upholstered back (UB).

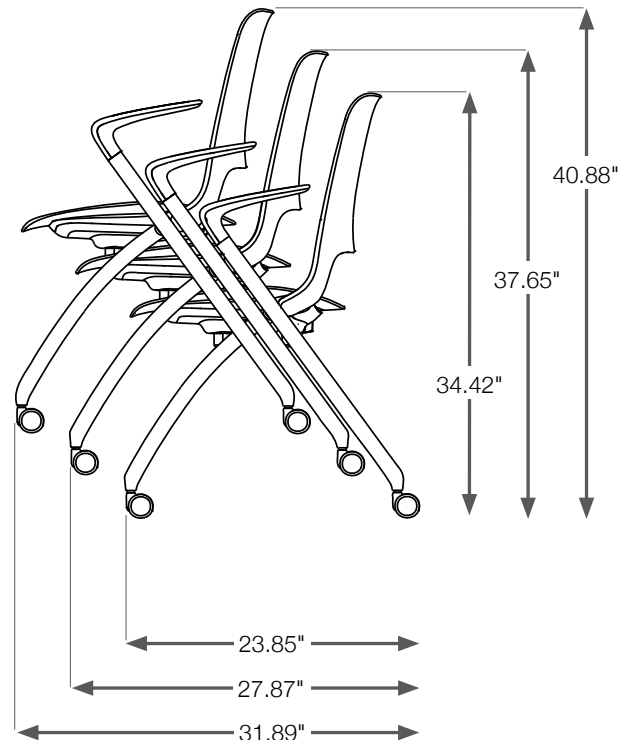
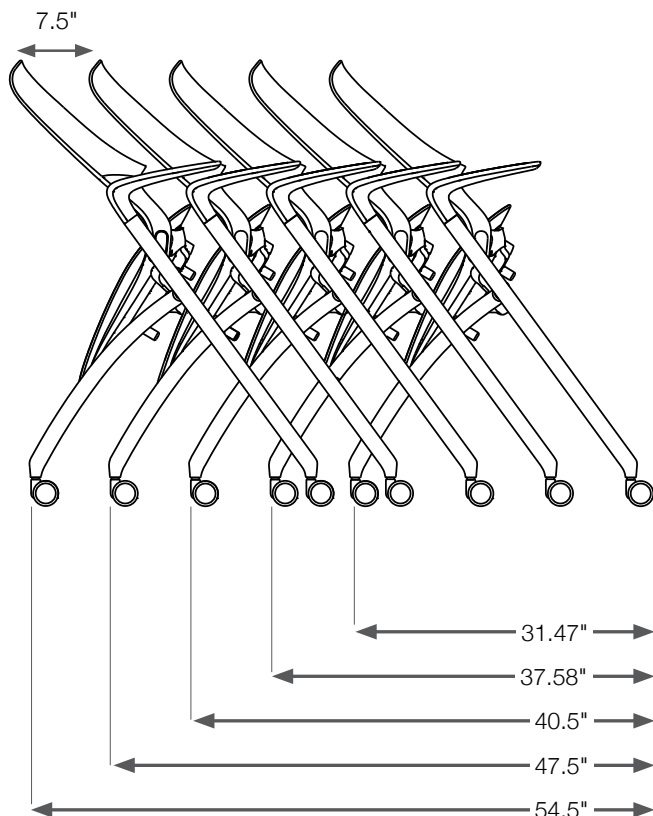

Focus Side

MULTIPURPOSE CHAIR, COUNTER STOOL AND BAR STOOL

Where comfort, style and ergonomics converge.

The revitalized Focus™ Side combines comfort and design for multi-purpose, office or reception areas. Choose either the 4-leg side chair, bar or counter stools in 3 back options – mesh, upholstered and wood. Two different frame finishes permit it to blend in—or stand out. Focus Side is part of a broad and versatile collection that includes executive and task models. Designed to complement Focus and Amplify task chairs.



Good
Featured with Black mesh
and SitOnIt Seating's Spice – Fire

EFFECTIVE NOVEMBER 4, 2024

Featured Models

GOOD :: \$524

Multipurpose chair, mesh back, upholstered seat, standard multi-surface glides, armless, grade 1 textile

BETTER :: \$573

Multipurpose chair, mesh back, upholstered seat, standard multi-surface glides, arms, grade 1 textile

BEST :: \$738

Multipurpose chair, clear maple slotted wood back, upholstered seat, arms, carpet casters, grade 1 textile

FOCUS SIDE

EFFECTIVE NOVEMBER 4, 2024 | GSA SIN #: 33721

Features

- 4-leg side chair, 30" bar and 24" counter stool models
- Three back options: mesh, wood and fully upholstered
- 15 bleach-cleanable mesh back colors
- Two wood back styles and four wood stain finishes
- Black or silver frame
- Upholstered waterfall seat
- Mesh back model stacks four on the floor, five on the optional cart; upholstered back model stacks three on the floor, three on the optional cart
- 300 lb weight capacity warranty
- Complements Focus and Focus 2.0 task chairs and stools; see [page 56](#) and [page 74](#)



Better
Featured with Apple mesh
and SitOnIt Seating's Dash — Cloud

MULTIPURPOSE CHAIR, COUNTER STOOL AND BAR STOOL

1. Frame

Model and Frame Finish	Code	Price	
Chairs			
Black	5651	\$573	
Silver	5652	\$573	
Black With Black Carpet Casters	5641	\$613	
Silver With Black Carpet Casters	5642	\$613	
Stools			
24" Black Counter Stool	5651 S9	\$723	
24" Silver Counter Stool	5652 S9	\$723	
30" Black Bar Stool	5651 S2	\$723	
30" Silver Bar Stool	5652 S2	\$723	



2. Back

Back Style	Code	Price	
Mesh	B1	+ \$0	
Upholstered	B3	+ \$58	
Solid Wood	WB1	+ \$125	
Slotted Wood	WB2	+ \$125	

FOCUS SIDE

EFFECTIVE NOVEMBER 4, 2024 | GSA SIN #: 33721

3. Arms

Arm Style	Code	Price	
Armless	A0	- \$49	
Fixed Loop	A130	+ \$0	

4. Base

Casters and Glides	Code	Price	
Casters			

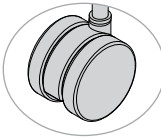
Carpet Casters	C13	+ \$0	
Hard Floor and Carpet Casters	C12	+ \$40	



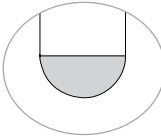
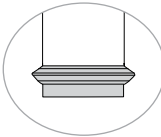
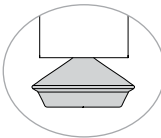
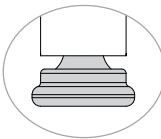

Casters and Glides	Code	Price	
Glides			

Standard Multi-Surface Glides	G5	+ \$0	
Floor Saver Glides	G12	+ \$17	
Performance Multi-Surface Glides	GL2	+ \$17	
Steel Glides (Carpet Only)	G13	+ \$17	

Please use caution when stacking models with casters to prevent frame damage. SitOnIt Seating does not warrant scratched frames. Casters are not available on counter stool (S9) or bar stool (S2).

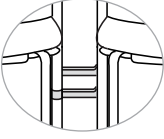
MULTIPURPOSE CHAIR, COUNTER STOOL AND BAR STOOL

5. Miscellaneous

Accessories	Code	Price	
Ganging Bracket for Armless Models	GG11	+ \$30	
Ganging Bracket for Models With Arms	GA11	+ \$30	
Stacking Cart	56-Cart	+ \$399	
Sector Seating Screen	3097 52X	+ \$460	

Ganging brackets and stacking carts are not intended for use with caster models or stools and are compatible with glides only. Wood back chairs (WB1/WB2) are not stackable. See page 630 for additional stacking requirements.

See Sector Seating Screens on page 584 for more specification details.



Best
Featured with a Clear Maple back and SitOnIt Seating's Sugar — Electric Blue

6. Material

Protection	Code	Price
Fire Retardancy		
CAL 133, Fabric, Quantities 1–49	133F	+ \$99
CAL 133, Fabric, Quantities 50+	133F5	+ \$55
CAL 133, Leather, Any Quantity	133L	+ \$119
Mesh Color (For B1)	Code	Price
Matches Amplify		
Apple	MC31	+ \$0
Aqua	MC30	+ \$0
Desert	MC9	+ \$0
Electric Blue	MC24	+ \$0
Fire	MC10	+ \$0
Fog	MC7	+ \$0
Navy	MC8	+ \$0
Nickel	MC6	+ \$0
Onyx	MC5	+ \$0
Tangerine	MC28	+ \$0
Matches Focus		
Black	MC1	+ \$0
Sand	MC3	+ \$0
Slate	MC2	+ \$0
Freeway Sport Stripe (Black/Slate)	MC33	+ \$0
Impress Sport Stripe (Slate/Black)	MC34	+ \$0
Wood Stain (For WB)	Code	Price
Amber Mahogany	S5	+ \$0
Clear Maple	S1	+ \$0
Espresso	S8	+ \$0
Medium Cherry	S3	+ \$0

Please reference the [Textile Reference Guide](#) for pricing on fabric over grade 7 and leather over grade 3. Additional CAL 133 information can be found on [page 15](#).

MULTIPURPOSE CHAIR, COUNTER STOOL AND BAR STOOL

6. Material (Cont.)

Textile	Code	Price
Seat Only (For B1/WB)		
Fabric/Vinyl Grade 1	FG1/VG1	+ \$0
COM	COM	+ \$24
Fabric/Vinyl Grade 2	FG2/VG2	+ \$24
Fabric/Vinyl Grade 3	FG3/VG3	+ \$45
Fabric/Vinyl Grade 4	FG4/VG4	+ \$77
Fabric/Vinyl Grade 5	FG5/VG5	+ \$116
Fabric/Vinyl Grade 6	FG6/VG6	+ \$159
Fabric/Vinyl Grade 7	FG7/VG7	+ \$200
Leather Grade 1	LG1	+ \$140
COL	COL	+ \$200
Leather Grade 2	LG2	+ \$200
Leather Grade 3	LG3	+ \$280
Seat and Back (For B3)		
Fabric/Vinyl Grade 1	FG1/VG1	+ \$0
COM	COM	+ \$36
Fabric/Vinyl Grade 2	FG2/VG2	+ \$36
Fabric/Vinyl Grade 3	FG3/VG3	+ \$74
Fabric/Vinyl Grade 4	FG4/VG4	+ \$121
Fabric/Vinyl Grade 5	FG5/VG5	+ \$174
Fabric/Vinyl Grade 6	FG6/VG6	+ \$235
Fabric/Vinyl Grade 7	FG7/VG7	+ \$296
Leather Grade 1	LG1	+ \$260
COL	COL	+ \$320
Leather Grade 2	LG2	+ \$320
Leather Grade 3	LG3	+ \$400

Please reference the [Textile Reference Guide](#) for pricing on fabric over grade 7 and leather over grade 3. Additional CAL 133 information can be found on [page 15](#).

Please reference the [Fabric information](#) found on [page 17](#) for pricing on multi-upholstery.

7. Packaging

Packaging	Code	Price
Fully Assembled In a Carton (Chairs)	AC3	+ \$0
Fully Assembled In a Carton, Individually Packed Chairs	AC1	+ \$20
Fully Assembled In a Carton, Individually Packed Stools	AC1	+ \$0

CHAIR SPECIFICATIONS

Model:	5651 / 5652 Side Chair	5641 / 5642 Side Chair with Casters
Dimensions		
Overall Width Armless	20.5"	20.5"
Overall Width With Arms	24.5"	24.5"
Overall Depth	26" (B1/WB) 25"(B3)	26" (B1/WB) 25" (B3)
Overall Height	34"(B1) 32.5" (B3/WB)	34" (B1) 32.5" (B3/WB)
Seat Width	18"	18"
Seat Depth	18.5"	18.5"
Seat Height	18"	18"
Back Width	20.5"	20.5"
Back Height	18"	18"
Materials		
COM	1 yd (B1/WB) 1.25 yd (B3)	1 yd (B1/WB) 1.25 yd (B3)
COL	12 sq ft (B1/WB) 20 sq ft (B3)	12 sq ft (B1/WB) 20 sq ft (B3)
Stacking		
Maximum Cart Stacking	5 (B1 Only) 3 (B3 Only)	5 (B1 Only) 3 (B3 Only)
Maximum Floor Stacking	4 (B1 Only) 3 (B3 Only)	4 (B1 Only) 3 (B3 Only)
Cart Stacking Weight Armless	133.5 lb	Not Recommended
Cart Stacking Weight With Arms	148.5 lb	Not Recommended
Floor Stacking Weight Armless	84 lb	Not Recommended
Floor Stacking Weight With Arms	96 lb	Not Recommended
Weight and Capacity		
Weight Armless	21 lb (B1/B3) 22 lb (WB)	21 lb (B1/B3) 22 lb (WB)
Weight With Arms	24 lb (B1/B3) 25 lb (WB)	24 lb (B1/B3) 25 lb (WB)
Weight Capacity Warranty	300 lb	300 lb

Mesh back (B1). Upholstered back (B3). Wood back (WB).

MULTIPURPOSE CHAIR, COUNTER STOOL AND BAR STOOL

STOOL SPECIFICATIONS

	5651 S9 / 5652 S9 24" Counter Stool	5652 S1 / 5652 S2 30" Bar Stool
Dimensions		
Overall Width Armless	20.5"	20.5"
Overall Width With Arms	24.5"	24.5"
Overall Depth	26" (B1/WB) 25" (B3)	26" (B1/WB) 25" (B3)
Overall Height	39.5" (B1) 37" (B3/WB)	46.5" (B1) 44" (B3/WB)
Seat Width	18"	18"
Seat Depth	18.5"	18.5"
Seat Height	24"	31"
Back Width	20.5"	20.5"
Back Height	18"	18"
Materials		
COM	1 yd (B1/WB) 1.25 yd (B3)	1 yd (B1/WB) 1.25 yd (B3)
COL	17 sq ft (B1/WB) 20 sq ft (B3)	17 sq ft (B1/WB) 20 sq ft (B3)
Weight and Capacity		
Weight Armless	28 lb (B1/B3) 29 lb (WB)	30 lb (B1/B3) 31 lb (WB)
Weight With Arms	31 lb (B1) 32 lb (B3/WB)	33 lb (B1) 34 lb (B3/WB)
Weight Capacity Warranty	300 lb	300 lb

Mesh back (B1). Upholstered back (B3). Wood back (WB).

Freelance

MULTIPURPOSE CHAIR, COUNTER STOOL AND BAR STOOL

Built for durability.

Imagine the versatility.

The transitional design of Freelance side chairs works well in lobby areas, workstations and offices. The comfortable, curved seat and structural integrity has made it a high-demand, multipurpose chair. Three frame/arm finish combinations create variety. Add casters or a book rack for ultimate mobility and flexibility in training rooms and collaborative spaces. Freelance is a broad collection of 4-leg chair, counter and bar stools.



Better
Featured with a Navy shell and
SitOnIt Seating's Huntington — Night

EFFECTIVE NOVEMBER 4, 2024

Featured Models

GOOD :: \$459

4-leg chair, all plastic seat and back, arms, standard multi-surface glides

BETTER :: \$517

4-leg chair, upholstered seat and plastic back, arms, standard multi-surface glides, grade 1 textile



BEST :: \$615

4-leg chair, upholstered seat and back, arms, carpet casters, grade 1 textile

Features

- Fully upholstered, upholstered seat or plastic
- Nine plastic colors
- Three frame/arm finish combinations: black and silver/slate.
- Waterfall seat
- Molded shroud underside
- Wall-saver frame design
- Optional book rack
- Stacks four on floor, six on the optional cart
- Weight capacity warranty:
300 lb for all plastic chairs and stools or upholstered chairs with casters;
400 lb for upholstered chairs with glides;
500 lb for Heavy Duty 24/7

1. Back

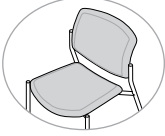
Back and Seat Style	Code	Price	
Plastic	No Code	\$459	
Upholstered Seat	US	\$517	
Upholstered Seat and Back	UP	\$575	

2. Super Duty

Heavy Duty Series	Code	Price	
Heavy Duty	HD	+ \$306	

Heavy Duty option only available on upholstered 4-leg chair frame (521) with glides. See the Super Duty Guide on [page 626](#) for additional high weight capacity models..

MULTIPURPOSE CHAIR, COUNTER STOOL AND BAR STOOL

3. Seat

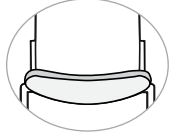
Seat Options	Code	Price	
1" Additional Foam	F1	+ \$36	



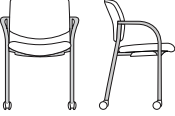
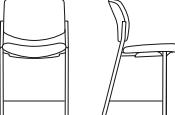
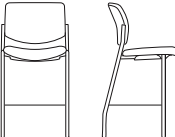

4. Frame

Frame Type	Code	Price	
Chairs			
4-Leg Chair	521X	+ \$0	
4-Leg Chair With Carpet Casters	522X	+ \$40	
Stools			
24" Counter Stool	5214 S9	+ \$150	
30" Bar Stool	5214 S2	+ \$150	

Frame Finish	Code	Price	
2-Day Lead Time			
Black	FB	+ \$0	
Silver	FS	+ \$0	

Arm color will match the frame color unless otherwise specified. "x" = arm or armless; see arms section on the following page.

5. Arms

Arm Style	Code	Price	
For Chairs			
Armless (Append Arm Code to Frame Type Code)	XXX3	- \$49	
Fixed Loop Arms (Append Arm Code to Frame Type Code)	XXX4	+ \$0	
For Stools			
Armless	5213	- \$49	
Fixed Loop Arms	5214	+ \$0	

Arm Color	Code	Price	
2-Day Lead Time			
Black	AC3	+ \$0	
Slate	AC4	+ \$0	

Arm color will match the frame color unless specified otherwise.

6. Base

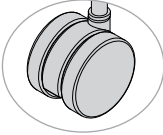
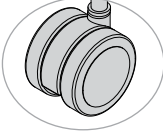
Casters or Glides	Code	Price	
Casters			
Carpet Casters	C13	+ \$0	
Hard Floor and Carpet Casters	C12	+ \$40	

Casters are not available on stool models.

MULTIPURPOSE CHAIR, COUNTER STOOL AND BAR STOOL

6. Base (Cont.)

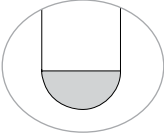
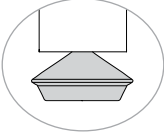
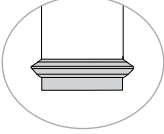
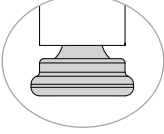
Arm Color	Code	Price	
Glides for 4-Leg Chair (521X/522X) and Stool (S2/S9)			
Standard Multi-Surface Glides	G5	+ \$0	
Performance Multi-Surface Glides	GL2	+ \$17	
Performance Multi-Surface Glides for Heavy Duty Option Only	GL2	+ \$0	
Floor Saver Glides	G12	+ \$17	
Steel Glides (Carpet Only)	G13	+ \$17	



Glides (GL2) are standard for Heavy Duty (HD) option.

Please use caution when stacking models with casters to prevent frame damage. SitOnIt Seating does not warrant scratched frames.



Good
Featured with a Lagoon shell

7. Miscellaneous

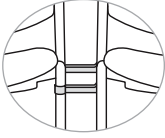
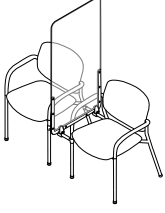
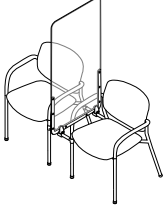
Accessories	Code	Price	
Book Rack (Black)	BRF	+ \$79	
Stacking Cart	14-Cart	+ \$399	
Ganging Bracket for Armless Models	GG2	+ \$30	
Ganging Bracket for Models With Arms	GA2	+ \$30	
Sector Seating Screen	3097 56X	+ \$460	

Accessories are not compatible with stool models (S2/(S9).

Book rack for 4-leg frame only. Book rack (BRF) and stacking cart (14-cart) are not for use with caster models (522x). See [page 630](#) for additional stacking requirements.

Please use caution when stacking models with casters to prevent frame damage. SitOnIt Seating does not warrant scratched frames.

See Sector Seating Screens on [page 584](#) for additional specification details.

8. Material

Protection	Code	Price	
Fire Retardancy			
CAL 133, Fabric, Quantities 1–49	133F	+ \$99	
CAL 133, Fabric, Quantities 50+	133F5	+ \$55	
CAL 133, Plastic, Any Quantity	133P	+ \$45	
Ballistic Nylon Back			
Ballistic Nylon Back	BN	+ \$0	

MULTIPURPOSE CHAIR, COUNTER STOOL AND BAR STOOL

8. Material (Cont.)

Shell Color	Code	Price	
Arctic	SC21	+ \$0	
Black	SC1	+ \$0	
Chocolate	SC4	+ \$0	
Lagoon	SC15	+ \$0	
Latte	SC20	+ \$0	
Navy	SC5	+ \$0	
Red	SC19	+ \$0	
Slate	SC8	+ \$0	
Sterling	SC18	+ \$0	
Textile			
Seat Only (For US)			
Fabric/Vinyl Grade 1	FG1/VG1	+ \$0	
COM	COM	+ \$24	
Fabric/Vinyl Grade 2	FG2/VG2	+ \$24	
Fabric/Vinyl Grade 3	FG3/VG3	+ \$45	
Fabric/Vinyl Grade 4	FG4/VG4	+ \$77	
Fabric/Vinyl Grade 5	FG5/VG5	+ \$116	
Fabric/Vinyl Grade 6	FG6/VG6	+ \$159	
Fabric/Vinyl Grade 7	FG7/VG7	+ \$200	
Seat and Back (UP)			
Fabric/Vinyl Grade 1	FG1/VG1	+ \$0	
COM	COM	+ \$36	
Fabric/Vinyl Grade 2	FG2/VG2	+ \$36	
Fabric/Vinyl Grade 3	FG3/VG3	+ \$74	
Fabric/Vinyl Grade 4	FG4/VG4	+ \$121	
Fabric/Vinyl Grade 5	FG5/VG5	+ \$174	
Fabric/Vinyl Grade 6	FG6/VG6	+ \$235	
Fabric/Vinyl Grade 7	FG7/VG7	+ \$296	
Leather/Ballistic Grade 1	LG1/BN1	+ \$140	
COL	COL	+ \$249	
Leather/Ballistic Grade 2	LG2/BN2	+ \$249	
Leather/Ballistic Grade 3	LG3/BN3	+ \$321	

Please reference the [Textile Reference Guide](#) for pricing on fabric over grade 7 and leather over grade 3. Additional CAL 133 information can be found on [page 15](#).

Please reference the Fabric information found on [page 17](#) for pricing on multi-upholstery.

9. Packaging

Packaging	Code	Price
Fully Assembled Stools in a Carton	AC	+ \$0
4-Leg Models		
Fully Assembled In a Carton, When 3 Are Ordered	3C	+ \$0
Fully Assembled in a Carton, When 2 Are Ordered	2C	+ \$10
Fully Assembled In a Carton, Individually Packaged	AC1	+ \$20

MULTIPURPOSE CHAIR, COUNTER STOOL AND BAR STOOL

CHAIR SPECIFICATIONS

Model:	5213 / 5214 / 5223 / 5224 4-Leg Chair
Dimensions	
Overall Width Armless	21.5"
Overall Width With Arms	25"
Overall Depth	24"
Overall Height	33.25"
Seat Width	19.5"
Seat Depth	18.5"
Seat Height	17.5"
Back Width	19.5"
Back Height	16"
Materials	
COM	.99 yd (US) .99 yd (US) (BN) 1.25 yd (UP) 1.15 yd (UP) (BN)
COL	15 sq ft (US) 15 sq ft (US) (BN) 25 sq ft (UP) 21 sq ft (UP) (BN)
Stacking	
Max Cart Stacking	6
Max Floor Stacking	4
Weight and Capacity	
Weight Armless	26.5 lb
Weight With Arms	28.5 lb
Weight Armless (3 Pack)	80 lb
Weight With Arms (3 Pack)	86 lb
Weight Capacity Warranty	300 lb (Plastic/US)(UP C12/C13) 400 lb (UP G5/GL2/G12/G13) 500 lb (HD)

Upholstered seat only (US). Upholstered seat and back (UP). Ballistic nylon (BN). Heavy Duty (HD).



*Best
Featured with SitOnIt Seating's
Venice — Gold Dusk*

FREELANCE

EFFECTIVE NOVEMBER 4, 2024 | GSA SIN #: 33721

MULTIPURPOSE CHAIR, COUNTER STOOL AND BAR STOOL

STOOL SPECIFICATIONS

Model:	5213 S9 / 5214 S9 24" Counter Stool	5213 S2 / 5214 S2 30" Bar Stool
Dimensions		
Overall Width Armless	21.5"	21.5"
Overall Width With Arms	25"	25"
Overall Depth	24"	24"
Overall Height	39"	45"
Seat Width	19.5"	19.5"
Seat Depth	18.5"	18.5"
Seat Height	24"	30"
Back Width	19.5"	19.5"
Back Height	16"	16"
Materials		
COM	0.99 yd (US)	0.99 yd (US)
	0.99 yd (US) (BN)	0.99 yd (US) (BN)
	1.25 yd (UP)	1.25 yd (UP)
	1.15 yd (UP) (BN)	1.15 yd (UP) (BN)
COL	15 sq ft (US)	15 sq ft (US)
	15 sq ft (US) (BN)	15 sq ft (US) (BN)
	25 sq ft (UP)	25 sq ft (UP)
	21 sq ft (UP) (BN)	21 sq ft (UP) (BN)
Weight and Capacity		
Weight Armless	24 lb	26 lb
Weight With Arms	26 lb	28 lb
Weight Capacity Warranty	300 lb (Plastic/US/UP)	300 lb (Plastic/US/UP)

Upholstered seat only (US). Upholstered seat and back (UP). Ballistic nylon back (BN).



Stool
Featured with SitOnIt Seating's
Venice — Sundown

Freelance

BARIATRIC CHAIR

Built for durability. Imagine the versatility.

The transitional design of Freelance bariatric side chairs works well in lobby areas and offices. The comfortable, curved seat and structural integrity has made it a high-demand, multipurpose chair. Three frame/arm finish combinations create variety. The Freelance collection is ideal for heavy-duty and bariatric applications.



30" Bariatric
Featured with SitOnIt Seating's Sugar — Electric Blue

EFFECTIVE NOVEMBER 4, 2024

Featured Models

30" BARIATRIC :: \$917

30" bariatric side, performance multi-surface glides, grade 1 textile



42" BARIATRIC :: \$1,334

42" bariatric side, performance multi-surface glides, grade 1 textile

Features

- Three frame/arm finish combinations: black and silver/slate
- Fully upholstered
- Waterfall seat
- Molded shroud underside
- Wall-saver frame design
- 600 lb weight capacity warranty on 30" model;
1,000 lb capacity on 42" model

1. Seat

Seat Size	Code	Price	
30" Seat With Arms (600 lb Weight Capacity)	5314	\$917	
42" Seat With Arms (1,000 lb Weight Capacity)	5414	\$1,334	

See the Super Duty Guide on [page 626](#) for additional high weight capacity models.

BARIATRIC CHAIR

2. Frame

Frame Finish	Code	Price	
2-Day Lead Time			
Black	FB	+ \$0	
Silver	FS	+ \$0	

Arm color will match the frame color unless otherwise specified.

3. Base

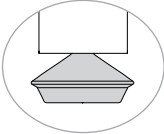
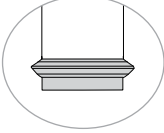
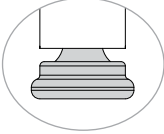
Glides	Code	Price	
Performance Multi-Surface Glides	GL2	+ \$0	
Floor Saver Glides	G12	+ \$17	
Steel Glides (Carpet Only)	G13	+ \$17	



4. Arms

Arm Color	Code	Price
Black	AC3	+ \$0
Slate	AC4	+ \$0



Arm color will match the frame color unless otherwise specified.

5. Material

Protection	Code	Price
Fire Retardancy		
CAL 133, Fabric, Quantities 1–49	133F	+ \$99
CAL 133, Fabric, Quantities 50+	133F5	+ \$55
CAL 133, Leather, Any Quantity	133L	+ \$119
Ballistic Nylon Back		
Ballistic Nylon Back	BN	+ \$0
Seat and Back Textile		
Fabric/Vinyl Grade 1	FG1/VG1	+ \$0
COM	COM	+ \$42
Fabric/Vinyl Grade 2	FG2/VG2	+ \$42
Fabric/Vinyl Grade 3	FG3/VG3	+ \$84
Fabric/Vinyl Grade 4	FG4/VG4	+ \$156
Fabric/Vinyl Grade 5	FG5/VG5	+ \$228
Fabric/Vinyl Grade 6	FG6/VG6	+ \$304
Fabric/Vinyl Grade 7	FG7/VG7	+ \$378
Leather Grade 1	LG1	+ \$240
COL	COL	+ \$540
Leather Grade 2	LG2	+ \$540
Leather Grade 3	LG3	+ \$820
Leather/Ballistic Grade 2	BN2	+ \$379
Leather/Ballistic Grade 3	BN3	+ \$631

Please reference the [Textile Reference Guide](#) for pricing on fabric over grade 7 and leather over grade 3. Additional CAL 133 information can be found on [page 15](#).

Please reference the [Fabric information](#) found on [page 17](#) for pricing on multi-upholstery.

BARIATRIC CHAIR

6. Packaging

Packaging	Code	Price
Fully Assembled in a Carton	AC	+ \$0

SPECIFICATIONS

Model:	5314 30" Bariatric Chair	5414 42" Bariatric Chair
Dimensions		
Overall Width With Arms	36.5"	48.5"
Overall Depth	25.5"	25.5"
Overall Height	32.5"	35"
Seat Width	30"	42"
Seat Depth	19"	18"
Seat Height	19"	19"
Back Width	30"	42"
Back Height	16"	16"
Materials		
COM	2.25 yd 1.67 yd (BN)	2.5 yd 1.75 yd (BN)
COL	40 sq ft 30 sq ft (BN)	42 sq ft 40 sq ft (BN)
Weight and Capacity		
Weight With Arms	42.5 lb	62.5 lb
Weight Capacity Warranty	600 lb	1,000 lb

Ballistic nylon (BN).

InFlex

MULTIPURPOSE CHAIR, COUNTER STOOL AND BAR STOOL

Geometry in motion.

Designed by Giancarlo Piretti, this multipurpose, stacking chair offers contemporary styling and spine-friendly comfort—at an affordable price.

Versatile InFlex comes in both plastic stacking side models and upholstered side, task and stool versions. The contemporary styling of this Piretti chair emulates the human spine. Its innovative flex-back disc system, with 13 degrees of back angle range, is as clever as it is comfortable.



Good
Featured with a Lagoon shell

EFFECTIVE NOVEMBER 4, 2024

Featured Models

GOOD :: \$357

4-leg chair, all plastic seat and back, armless, standard multi-surface glides

BETTER :: \$422

4-leg chair, plastic back, upholstered seat, armless, standard multi-surface glides, grade 1 textile

BEST :: \$545



4-leg chair, upholstered seat and back, fixed cantilever arms, standard multi-surface glides, grade 1 textile

MULTIPURPOSE CHAIR, COUNTER STOOL AND BAR STOOL

Features

- Giancarlo Piretti design
- Innovative disc system emulates the human spine
- Plastic model stack five on the floor, 12 on the optional cart
- Upholstered armless model stack five on the floor; 10 on the optional cart
- Fully upholstered, upholstered seat or plastic
- Nine plastic colors
- Two frame finishes
- 300 lb weight capacity warranty
- Complements InFlex light task chair and stool; see [page 98](#)

1. Back

Seat and Back Style	Code	Price	
Plastic	No Code	\$357	
Upholstered Seat Only	US	\$422	
Upholstered Seat and Back	UP	\$487	

Do not stack upholstered chairs with arms.

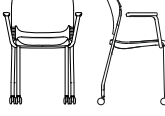

2. Frame

Frame Type	Code	Price	
4-Leg	971	+ \$0	
4-Leg With Black Carpet Casters	974	+ \$40	
24" Counter Stool	971 S9	+ \$150	
30" Bar Stool	971 S2	+ \$150	

Frame Finish	Code	Price	
Black	FC1	+ \$0	
Silver	FC2	+ \$0	

Counter (S9) and bar (S2) stools are available with glides only.

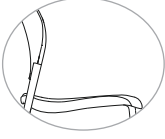
Arms

Arm Style	Code	Price	
Armless	A0	+ \$0	
Fixed Cantilever	A121	+ \$58	

3. Arms (Cont.)

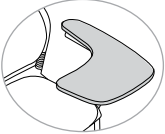
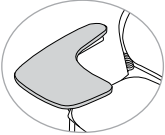
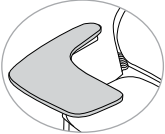
Tablet Arms	Code	Price	
3-Week Lead Time			
Tablet Arm, Left	TLI	+\$200	
Tablet Arm, Right	TRI	+\$200	
Oversized Tablet Arm, Right	TIO	+\$300	
Tablet Laminate Color	Code	Price	
Black	1	+\$0	
Tablet Edge Color	Code	Price	
Black	TE1	+\$0	

Tablet arms are not available with stools or casters. Not stackable. Tablet arms are not available with stools or casters. Not stackable.

4. Base

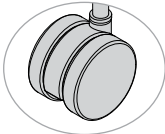
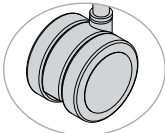
Casters or Glides	Code	Price	
Casters			
Carpet Casters	C13	+\$0	
Hard Floor and Carpet Casters	C12	+\$40	

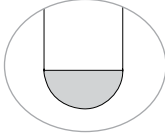
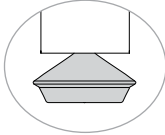
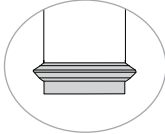
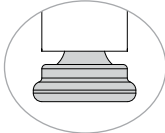

MULTIPURPOSE CHAIR, COUNTER STOOL AND BAR STOOL

4. Base (Cont.)

Casters or Glides (Cont.)	Code	Price	
Glides			
Standard Multi-Surface Glides	G11	+\$0	
Performance Multi-Surface Glides	GL2	+\$20	
Floor Saver Glides	G12	+\$20	
Steel Glides (Carpet Only)	G13	+\$20	

Please use caution when stacking models with casters to prevent frame damage. SitOnIt Seating does not warrant scratched frames.

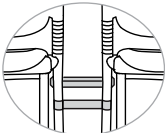
5. Miscellaneous

Accessories	Code	Price	
Ganging Bracket for Armless Models	GG9	+\$30	
Ganging Bracket for Models With Arms	GA9	+\$30	
Stacking Cart	97-Cart	+\$399	

Ganging brackets and stacking carts are not intended for use with caster models and are compatible with glides only.

Due to the nature of upholstery, stacking may cause impressions on the seat. SitOnIt Seating does not warrant the effects of stacking on upholstery.

See [page 630](#) for additional stacking requirements.

6. Material

Protection	Code	Price
Fire Retardancy		
CAL 133, Fabric, Quantities 1–49	133F	+ \$99
CAL 133, Fabric, Quantities 50+	133F5	+ \$55
CAL 133, Plastic, Any Quantity	133P	+ \$45
Shell Color (For Plastic and US)	Code	Price
Arctic	SC21	+ \$0
Black	SC1	+ \$0
Chocolate	SC4	+ \$0
Lagoon	SC15	+ \$0
Latte	SC20	+ \$0
Navy	SC5	+ \$0
Red	SC19	+ \$0
Slate	SC8	+ \$0
Sterling	SC18	+ \$0
Textile	Code	Price
Seat Only (For US)		
Fabric/Vinyl Grade 1	FG1/VG1	+ \$0
COM	COM	+ \$24
Fabric/Vinyl Grade 2	FG2/VG2	+ \$24
Fabric/Vinyl Grade 3	FG3/VG3	+ \$45
Fabric/Vinyl Grade 4	FG4/VG4	+ \$77
Fabric/Vinyl Grade 5	FG5/VG5	+ \$116
Fabric/Vinyl Grade 6	FG6/VG6	+ \$159
Fabric/Vinyl Grade 7	FG7/VG7	+ \$200
Seat and Back (For UP)		
Fabric/Vinyl Grade 1	FG1/VG1	+ \$0
COM	COM	+ \$36
Fabric/Vinyl Grade 2	FG2/VG2	+ \$36
Fabric/Vinyl Grade 3	FG3/VG3	+ \$74
Fabric/Vinyl Grade 4	FG4/VG4	+ \$121
Fabric/Vinyl Grade 5	FG5/VG5	+ \$174
Fabric/Vinyl Grade 6	FG6/VG6	+ \$235
Fabric/Vinyl Grade 7	FG7/VG7	+ \$296

Please reference the [Textile Reference Guide](#) for pricing on fabric over grade 7. Additional CAL 133 information can be found on [page 15](#).

Please reference the [Fabric information](#) found on [page 17](#) for pricing on multi-upholstery.

MULTIPURPOSE CHAIR, COUNTER STOOL AND BAR STOOL

7. Packaging

Packaging	Code	Price
Fully Assembled in a Carton	AC4	+ \$0
Fully Assembled Stools in a Carton, Individually Packaged	AC1	+ \$20
Fully Assembled Chairs in a Carton, Individually Packaged	AC1	+ \$20

SPECIFICATIONS

Model:	971 / 974 Multipurpose Chair	971 S9 24" Counter Stool	971 S2 30" Bar Stool
Dimensions			
Overall Width Armless	20"	19.75"	19.75"
Overall Width With Arms	24.125"	25"	25"
Overall Depth	22"	22.25"	22.25"
Overall Height	33"	38.5"	43.5"
Seat Width	17"	16.75"	16.75"
Seat Depth	17"	18.5"	18.5"
Seat Height	18"	24"	29"
Back Width	20"	19.75"	19.75"
Back Height	15.5"	15.5"	15.5"
Materials			
COM	0.85 yd (US) 1 yd (UP)	0.85 yd (US) 1 yd (UP)	0.85 yd (US) 1 yd (UP)
Stacking			
Max Cart Stacking	12 (Plastic) 10 (US/UP)	N/A	N/A
Max Floor Stacking	5	5	5
Weight and Capacity			
Weight Armless	18 lb	22 lb	23 lb
Weight With Arms	22 lb	26 lb	27 lb
Weight Capacity Warranty	300 lb	300 lb	300 lb

Upholstered seat only (US). Upholstered seat and back (UP).

Ioniq

GUEST CHAIR

Inspire unique.

There's a specialness that flows through Ioniq. Its form and feeling are fluid—from the way the arms stretch seamlessly out of a sculpted shell to base options that are as varied and versatile as the spaces they occupy. Because when you desire aesthetics that elevate any experience and offer something refreshingly different, there's only one go-to. And that's Ioniq.



*Ioniq Guest
Featured with SitOnIt Seating's
Venice — Sundown*

EFFECTIVE NOVEMBER 4, 2024

Featured Models

GUEST :: \$899

Plastic back, upholstered seat, integrated arms, 360-degree swivel, 4-star polished aluminum base. standard multi-surface glides, grade 1 textile

Features

- Breathable back with built-in lumbar support
- Minimalist-designed mechanism with streamlined controls
- Edge-to-edge cushion
- Fully integrated armrests
- Single-piece sculpted shell
- 4-star aluminum base
- 300 lb weight capacity warranty
- Complements Ioniq collaborative; see [page 101](#)

1. Frame

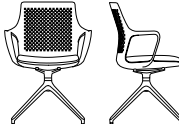
Frame Type	Code	Price	
Guest (4-Star Base)	1152 FT5	\$899	

Seat and Back Style	Code	Price	
Plastic Back With Upholstered Seat Pad	US PB	+ \$0	

Shell Color	Code	Price	
Black	SC1	+ \$0	
White	SC26	+ \$0	

2. Base

Base Type and Material	Code	Price	
4-Star Polished Aluminum	BT5	+ \$0	

Glides	Code	Price	
Standard Multi-Surface Glides	GL1	+ \$0	

3. Mechanism

Mechanism Style	Code	Price	
360-Degree Swivel	FHB	+ \$0	

GUEST CHAIR

4. Material

Seat Textile	Code	Price	
Fabric/Vinyl Grade 1	FG1/VG1	+ \$0	
COM	COM	+ \$24	
Fabric/Vinyl Grade 2	FG2/VG2	+ \$24	
Fabric/Vinyl Grade 3	FG3/VG3	+ \$45	
Fabric/Vinyl Grade 4	FG4/VG4	+ \$77	
Fabric/Vinyl Grade 5	FG5/VG5	+ \$116	
Fabric/Vinyl Grade 6	FG6/VG6	+ \$159	
Fabric/Vinyl Grade 7	FG7/VG7	+ \$200	
Leather Grade 1	LG1	+ \$140	
COL	COL	+ \$200	
Leather Grade 2	LG2	+ \$200	
Leather Grade 3	LG3	+ \$280	

Please reference the [Textile Reference Guide](#) for pricing on fabric over grade 7 and leather over grade 3.

5. Packaging

Packaging	Code	Price	
Back Attached to Seat, Base Separate	UC	+ \$0	
Fully Assembled in a Carton	AC	+ \$120	

SPECIFICATIONS

	1152 FT5 Guest Chair
Dimensions	
Overall Width	28.25"
Overall Depth	28.24"
Overall Height	34.5"
Seat Width	17.5"
Seat Depth	17.38"
Seat Height	18.25"
Back Width	18"
Back Height	17.38"
Materials	
COM	0.75 yd
COL	7 sq ft
Weight and Capacity	
Weight	18.5 lb
Weight Capacity Warranty	300 lb

Chair is widest at the base.

Ioniq

SIDE CHAIR

Inspire unique.

There's a specialness that flows through Ioniq. Its form and feeling are fluid—from the way the arms stretch seamlessly out of a sculpted shell to base options that are as varied and versatile as the spaces they occupy. Because when you desire aesthetics that elevate any experience and offer something refreshingly different, there's only one go-to. And that's Ioniq.



Ioniq Side
Featured with SitOnIt Seating's
Venice — Sundown

EFFECTIVE NOVEMBER 4, 2024

Featured Models

SIDE :: \$684

4-leg, chrome finish, plastic back with upholstered seat pad, integrated arms, standard multi-surface glides, grade 1 textile

Features

- Breathable back with built-in lumbar support
- Edge-to-edge cushion
- Fully integrated armrests
- Single-piece sculpted shell
- 4-leg base
- 300 lb weight capacity warranty
- Complements Ioniq collaborative; see [page 101](#)

1. Frame

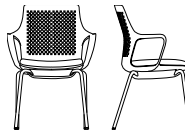
Frame Type	Code	Price	
4-Leg	1151 FT1	\$684	

Frame Finish	Code	Price	
Chrome	FC15	+ \$0	

Do not stack Ioniq side chairs. Frames are not stackable.

2. Seat and Back

Seat and Back Style	Code	Price	
Plastic Back With Upholstered Seat Pad	US PB	+ \$0	

3. Base

Glides	Code	Price	
Standard Multi-Surface Glides	GL1	+ \$0	

SIDE CHAIR

4. Material

Shell Color	Code	Price	
Black	SC1	+ \$0	
White	SC26	+ \$0	
Seat Textile	Code	Price	
Fabric/Vinyl Grade 1	FG1/VG1	+ \$0	
COM	COM	+ \$24	
Fabric/Vinyl Grade 2	FG2/VG2	+ \$24	
Fabric/Vinyl Grade 3	FG3/VG3	+ \$45	
Fabric/Vinyl Grade 4	FG4/VG4	+ \$77	
Fabric/Vinyl Grade 5	FG5/VG5	+ \$116	
Fabric/Vinyl Grade 6	FG6/VG6	+ \$159	
Fabric/Vinyl Grade 7	FG7/VG7	+ \$200	
Leather Grade 1	LG1	+ \$140	
COL	COL	+ \$200	
Leather Grade 2	LG2	+ \$200	
Leather Grade 3	LG3	+ \$280	

Please reference the [Textile Reference Guide](#) for pricing on fabric over grade 7.

5. Packaging

Packaging	Code	Price	
Fully Assembled in a Carton	AC	+ \$0	

One per carton only.

SPECIFICATIONS

Model:	1151 FT1 4-Leg Multipurpose Chair
Dimensions	
Overall Width	23"
Overall Depth	21.38"
Overall Height	32.5"
Seat Width	17.5"
Seat Depth	17.38"
Seat Height	17.63"
Back Width	18"
Back Height	17.38"
Materials	
COM	0.75 yd
COL	7 sq ft
Weight and Capacity	
Weight	15.5 lb
Weight Capacity Warranty	300 lb

Kickstand

STOOL

Lean into work.

Introducing a whole new way to work. There's sitting. There's standing. And now there's perching with Kickstand™. It's an active alternative that provides limitless opportunities for body-benefitting postures, giving you the support you need to lean forward and focus on what's in front of you.



Black
Featured with SitOnIt Seating's
Venice – Mainstream

EFFECTIVE NOVEMBER 4, 2024

Featured Models

BLACK :: \$591

Black finish, upholstered seat and grade 1 fabric

FOG :: \$626

Fog finish, upholstered seat and grade 1 fabric

Features

- Ergo-sculpted, bolstered seat alleviates pressure points while offering soft, flexible edges
- Customize the cushion with access to thousands of fabrics
- Lightweight frame with easy-grip handle means your new posture is always within reach
- Included auto-return cylinder ensures the seat always faces forward
- Streamlined ambidextrous controls make it easy to adjust from either side for various worksurface heights
- Stable, non-slip base with responsive 360-degree pivoting support keeps you energized and productive
- 250 lb weight capacity warranty

1. Frame

Frame Type	Code	Price
------------	------	-------

Sit-to-Stand Stool	1167	\$591
--------------------	------	-------

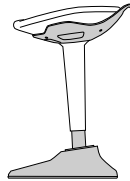

Frame Finish	Code	Price
--------------	------	-------

Black	FC1	+ \$0
Fog	FC13	+ \$35

Frame finish applies to base, column cover and outer seat.

2. Seat

Seat Style	Code	Price
------------	------	-------

Upholstered Seat	US	+ \$0
------------------	----	-------

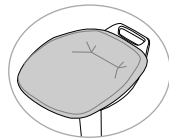

STOOL

3. Base

Stool Kit	Code	Price
-----------	------	-------

Extended Stool Kit	S2	+ \$0
--------------------	----	-------

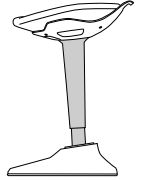

4. Material

Seat Textile	Code	Price
--------------	------	-------

Fabric Grade 1	FG1	+ \$0
COM	COM	+ \$24
Fabric Grade 2	FG2	+ \$24
Fabric Grade 3	FG3	+ \$45
Fabric Grade 4	FG4	+ \$77
Fabric Grade 5	FG5	+ \$116
Fabric Grade 6	FG6	+ \$159
Fabric Grade 7	FG7	+ \$200

Please reference the [Textile Reference Guide](#) for pricing on fabric over grade 7.

To minimize the risk of injury from sliding off Kickstand's forward-tilting seat, SitOnIt Seating does not offer vinyl or leather upholstery options.

5. Packaging

Packaging	Code	Price
-----------	------	-------

Knocked Down - Individually Packaged	KD	+ \$0
--------------------------------------	----	-------

SPECIFICATIONS

Model:	1167 Stool
Dimensions	
Overall Width	15.5"
Overall Depth	18.125"
Overall Height	25.75"-35.875"
Seat Width	15.25"
Seat Depth	15.25"
Seat Height	23.5"-33.75"
Materials	
COM	0.75 yd
Weight	17.5 lb
Weight and Capacity	
Weight Capacity Warranty	250 lb

Lumin

MULTIPURPOSE CHAIR, COUNTER STOOL AND BAR STOOL

Light up the room.

Lumin is an elegant multipurpose stackable chair designed for exceptional support and comfort in corporate and education applications. The contoured seat dissipates pressure points for greater comfort while the perforated back adds contemporary style and comfortable breathability. The Lumin multipurpose stackable chair, counter and bar stools are available in black, silver or chrome frame finish with matching arm pad colors. Refined, sophisticated Lumin will light up the room.



Good
Featured with a Pacific shell

EFFECTIVE NOVEMBER 4, 2024

Featured Models

GOOD :: \$325

4-leg chair, plastic seat and back, armless, standard multi-surface glides

BETTER :: \$390

4-leg chair, upholstered seat, armless, standard multi-surface glides, grade 1 textile

BEST :: \$513

4-leg chair, upholstered seat and back, fixed arms, standard multi-surface glides, grade 1 textile

Features

- Contemporary design
- 4-leg and wire rod chair, counter and bar stools
- Exceptional support and comfort
- Fully upholstered, upholstered seat or plastic
- 14 plastic shell colors
- Three frame finishes with matching arm pads
- Left or right folding tablet arm in two finishes
- Built-in pull handle
- Clean-out space
- 4-leg plastic model stacks six on the floor; eight on the optional cart
- Wire frame plastic model stacks eight on the floor; 15 on the optional cart
- 300 lb weight capacity warranty
- Complements Lumin light task chair and stool; see [page 115](#)

1. Frame

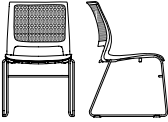
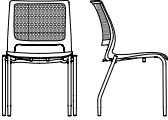
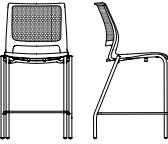
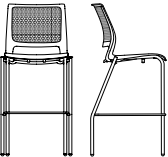
Frame Type	Code	Price	
Wire Rod	1011 FT2	\$302	
4-Leg	1011 FT1	\$325	
24" Counter Stool	1011 FT1 S9	\$475	
30" Bar Stool	1011 FT1 S2	\$475	

Counter (S9) and bar (S2) stools are only available with glides.



MULTIPURPOSE CHAIR, COUNTER STOOL AND BAR STOOL

1. Frame (Cont.)



Frame Finish	Code	Price	
Black	FC1	+ \$0	
Silver (For 4-Leg Frame)	FC2	+ \$0	
Chrome (For Wire Rod Frame)	FC15	+ \$0	

Arms and glides, if specified, are black for black frames and fog for silver or chrome frames.

2. Back

Back and Seat Style	Code	Price	
Plastic Seat	PS	+ \$0	
Upholstered Seat Only	US	+ \$65	
Upholstered Seat and Back	UP	+ \$130	

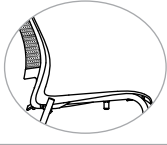
3. Arms

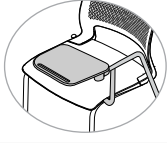
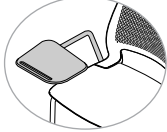
Arm Style	Code	Price	
Armless	A0	+ \$0	
Fixed (For 4-Leg Frame)	A147	+ \$58	
Fixed (For Wire Rod Frame)	A146	+ \$58	
Tablet Arm	Code	Price	
Folding Tablet Arm, Left	RMTL	+ \$200	
Folding Tablet Arm, Right	RMTR	+ \$200	

Tablet arms are not available with stools (S9/S2). Tablet arms are not stackable. Tablet arm will be black for black (FC1) frame or fog for silver (FC2) frame.

4. Base

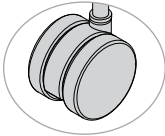
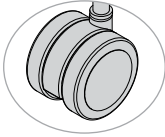
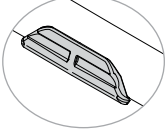
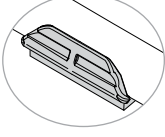
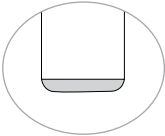
Casters or Glides	Code	Price	
Casters			
Carpet Casters	C13	+ \$40	
Hard Floor and Carpet Casters	C12	+ \$80	
Glides for Wire Rod Frames			
No Glides	G0	+ \$0	
Clear Glides	CGR	+ \$9	
Clear Glides With Felt	CGRF	+ \$27	
Glides for 4-Leg Frames			
Standard Multi-Surface Glides	GL1	+ \$0	
Floor Saver Glides	GL3	+ \$20	
Steel Glides (Carpet Only)	GL4	+ \$20	
Performance Multi-Surface Glides	GL2	+ \$20	

Counter (S9) and bar (S2) stools are only available with glides.

Please use caution when stacking models with casters to prevent frame damage. SitOnIt Seating does not warrant scratched frames.

5. Miscellaneous

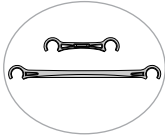
Ganging	Code	Price	
Ganging Bracket for 4-Leg Armless Models	GG10	+ \$30	
Ganging Bracket for 4-Leg Models With Arms	GA10	+ \$30	
Ganging Bracket for Wire Rod Armless Models	GG3	+ \$30	
Ganging Bracket for Wire Rod Models With Arms	GA3	+ \$30	

MULTIPURPOSE CHAIR, COUNTER STOOL AND BAR STOOL

5. Miscellaneous

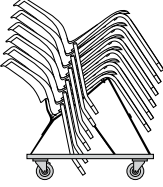
Stacking	Code	Price	
Stacking Cart	1011-CART	+ \$399	

Stacking carts require assembly.

Ganging brackets and stacking carts are not intended for use with caster models and are compatible with glides only. See [page 630](#) for additional stacking requirements.

6. Material

Protection	Code	Price	
Fire Retardancy			
CAL 133, Fabric, Quantities 1-49	133F	+ \$64	
CAL 133, Fabric, Quantities 50+	133F5	+ \$20	
CAL 133, Plastic, Any Quantity	133P	+ \$10	



Best
Featured with a Lemon shell and SitOnIt Seating's Venice — Gold Dusk

6. Material (Cont.)

Shell Color	Code	Price
Apple	SC24	+ \$0
Arctic	SC21	+ \$0
Bisque	SC7	+ \$0
Black	SC1	+ \$0
Chocolate	SC4	+ \$0
Lagoon	SC15	+ \$0
Latte	SC20	+ \$0
Lemon	SC25	+ \$0
Navy	SC5	+ \$0
Pacific	SC22	+ \$0
Red	SC19	+ \$0
Slate	SC8	+ \$0
Sterling	SC18	+ \$0
Tangerine	SC23	+ \$0

Textile	Code	Price
Seat Only (For US)		
Fabric/Vinyl Grade 1	FG1/VG1	+ \$0
COM	COM	+ \$24
Fabric/Vinyl Grade 2	FG2/VG2	+ \$24
Fabric/Vinyl Grade 3	FG3/VG3	+ \$45
Fabric/Vinyl Grade 4	FG4/VG4	+ \$77
Fabric/Vinyl Grade 5	FG5/VG5	+ \$116
Fabric/Vinyl Grade 6	FG6/VG6	+ \$159
Fabric/Vinyl Grade 7	FG7/VG7	+ \$200
Seat and Back (For UP)		
Fabric/Vinyl Grade 1	FG1/VG1	+ \$0
COM	COM	+ \$36
Fabric/Vinyl Grade 2	FG2/VG2	+ \$36
Fabric/Vinyl Grade 3	FG3/VG3	+ \$74
Fabric/Vinyl Grade 4	FG4/VG4	+ \$121
Fabric/Vinyl Grade 5	FG5/VG5	+ \$174
Fabric/Vinyl Grade 6	FG6/VG6	+ \$235
Fabric/Vinyl Grade 7	FG7/VG7	+ \$296

Please reference the [Textile Reference Guide](#) for pricing on fabric over grade 7. Additional CAL 133 information can be found on [page 15](#).

Please reference the [Fabric information](#) found on [page 17](#) for pricing on multi-upholstery.

MULTIPURPOSE CHAIR, COUNTER STOOL AND BAR STOOL

7. Packaging

Packaging	Code	Price
Fully Assembled in a Carton	AC	+ \$0
Fully Assembled in a Carton, Individually Packaged	AC1	+ \$20

CHAIR SPECIFICATIONS

Model:	1011 FT1 4-Leg Multipurpose Chair	1011 FT2 Wire Rod Multipurpose Chair
Dimensions		
Overall Width Armless	21.3" (Glides) 22.3" (Casters)	20.7"
Overall Width With Arms	26.8"	24.9"
Overall Depth	22.1"	22.8"
Overall Height	32.9"	32.9"
Seat Width	19"	19"
Seat Depth	18.7"	18.7"
Seat Height	17.3"	17.3"
Back Width	18.3"	18.3"
Back Height	16.7"	16.7"
Materials		
COM	0.85 yd (US) 1 yd (UP)	0.85 yd (US) 1 yd (UP)
Stacking		
Max Cart Stacking	8 (PS), 6 (US/UP)	15 (PS), 6 (US/UP)
Max Floor Stacking	6 (PS), 4 (US/UP)	8 (PS), 4 (US/UP)
Weight and Capacity		
Weight Armless	13 lb (PS), 13.8 lb (US), 14.3 lb (UP)	15 lb (PS), 15.8 lb (US), 16.3 lb (UP)
Weight With Arms	14 lb (PS), 14.8 lb (US), 15.3 lb (UP)	18.5 lb (PS), 19.3 lb (US), 19.8 lb (UP)
Weight Capacity Warranty	300 lb	300 lb

Upholstered seat only (US). Upholstered seat and back (UP).

MULTIPURPOSE CHAIR, COUNTER STOOL AND BAR STOOL

STOOL SPECIFICATIONS

Model:	1011 S9 24" Counter Stool	1011 S2 30" Bar Stool
Dimensions		
Overall Width Armless	21.3"	21.3"
Overall Width With Arms	26.8"	26.8"
Overall Depth	22.1"	22.1"
Overall Height	40"	45.1"
Seat Width	19"	19"
Seat Depth	18.7"	18.7"
Seat Height	24.25"	29.5"
Back Width	18.3"	18.3"
Back Height	16.7"	16.7"
Materials		
COM	0.85 yd (US) 1 yd (UP)	0.85 yd (US) 1 yd (UP)
Weight and Capacity		
Weight Armless	17 lb	20.3 lb
Weight With Arms	18.7 lb	21.9 lb
Weight Capacity Warranty	300 lb	300 lb

Upholstered seat only (US). Upholstered seat and back (UP).



Better
Featured with a Tangerine shell and
SitOnIt Seating's Malibu — Ruby

Mika

MULTIPURPOSE CHAIR, COUNTER STOOL AND BAR STOOL

Design above.

Mika sits above most others in its class—and not just because it was a multi-award winner. Mika is elevated. Upholstered or non-upholstered, it reaches new heights in what a molded shell chair can be. From top to bottom, the design flows. Back and forth, the design rocks with 15 degrees of flex. Up and up, the design pushes an upholstered seat farther than ever before. And in the end, you arrive at a place of sit-ability and stack-ability hard to find in something that looks this good.



Best
Featured with a Fog shell and
SitOnIt Seating's Dash — Sky



reddot winner 2021



EFFECTIVE NOVEMBER 4, 2024

Featured Models

GOOD :: \$385

4-leg, all plastic, armless,
standard multi-surface glides

BETTER :: \$461

Wire rod, upholstered seat, armless, no
glides, grade 1 textile



BEST :: \$484

4-leg, upholstered seat, armless,
standard multi-surface glides,
grade 1 textile

Features

- Designed by ITO Design
- Single-piece shell with 15 degrees of backrest flex
- Sculpted shell provides a natural cradle
- Optional $\frac{2}{3}$ upholstered seat available in 15,000+ textiles
- Base options include 4-leg, wire rod, wire rod counter stool and wire rod bar stool
- Three neutral shell colors
- White, black, fog and chrome frame finishes
- Wire rod model stacks up to 30 chairs on a cart
- Upholstered 4-leg model stacks up to nine chairs on the floor
- 300 lb weight capacity warranty

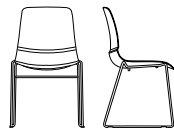
1. Frame

Frame Type	Code	Price	
4-Leg	1101 FT1	\$385	
Wire Rod	1101 FT2	\$362	
24" Wire Rod Counter Stool	1101 FT2 S9	\$512	
30" Wire Rod Bar Stool	1101 FT2 S2	\$512	

MULTIPURPOSE CHAIR AND BAR STOOL

1. Frame

Frame Finish	Code	Price	
For 4-Leg Frame (FT1)			
Black	FC1	+ \$0	
Fog	FC13	+ \$0	
White	FC12	+ \$0	
For Wire Rod Frame (FT2)			
Black	FC1	+ \$0	
Chrome	FC15	+ \$0	

2. Seat

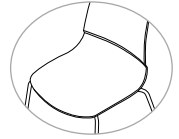
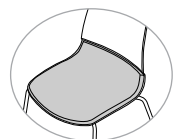
Seat Style	Code	Price	
Plastic Seat	PS	+ \$0	
Upholstered Seat ($\frac{2}{3}$ Upholstered Wrap)	US	+ \$99	



3. Arms

Arm Style	Code	Price	
Armless	AR0	+\$0	

4. Base

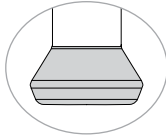
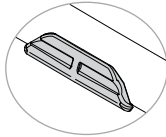
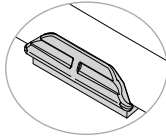
Glides	Code	Price	
For 4-Leg Frame (FT1)			
Standard Multi-Surface Glides	GL1	+\$0	
For Wire Rod Frame (FT2)			
No Glides	G0	+\$0	
Clear Glides	CGR	+\$9	
Clear Glides With Felt	CGRF	+\$27	

5. Miscellaneous

Accessories	Code	Price	
Stacking Cart	CART	+\$399	

Stacking carts require assembly.

Please use caution when stacking to prevent frame damage. SitOnIt Seating does not warrant scratched frames.

Due to the nature of upholstery, stacking may cause impressions on the seat. SitOnIt Seating does not warrant the effects of stacking on upholstery.

Wire rod bar stools (S2) do not stack on cart. See page 630 for additional stacking requirements.

MULTIPURPOSE CHAIR AND BAR STOOL

6. Material

Protection	Code	Price	
Fire Retardancy			
CAL 133, Fabric, Quantities 1-49	133F	+\$64	
CAL 133, Fabric, Quantities 50+	133F5	+\$20	
CAL 133, Plastic, Any Quantity	133P	+\$10	
Shell Color	Code	Price	
Black	SC1	+\$0	
White	SC26	+\$0	
Fog	SC27	+\$0	
Seat Textile (For US)	Code	Price	
Fabric/Vinyl Grade 1	FG1/VG1	+\$0	
COM	COM	+\$24	
Fabric/Vinyl Grade 2	FG2/VG2	+\$24	
Fabric/Vinyl Grade 3	FG3/VG3	+\$45	
Fabric/Vinyl Grade 4	FG4/VG4	+\$77	
Fabric/Vinyl Grade 5	FG5/VG5	+\$116	
Fabric/Vinyl Grade 6	FG6/VG6	+\$159	
Fabric/Vinyl Grade 7	FG7/VG7	+\$200	

Please reference the [Textile Reference Guide](#) for pricing on fabric over grade 7. Additional CAL 133 information can be found on [page 15](#).

7. Packaging

Packaging	Code	Price	
Fully Assembled in a Carton	AC	+\$0	
Fully Assembled in a Carton, Individually Packaged	AC1	+\$20	

CHAIR SPECIFICATIONS

Model:	1101 FT1 4-Leg Chair	1101 FT2 Wire Rod Chair
Dimensions		
Overall Width	22.75"	19.65"
Overall Depth	19.5"	19.5"
Overall Height	32.15"	32.4"
Seat Width	17.5"	17.5"
Seat Depth	16.75"	16.75"
Seat Height	18.5"	18.5"
Back Width	16.25"	16.25"
Back Height	16.25"	16.25"
Materials		
COM	0.85 yd	0.85 yd
Stacking		
Max Floor Stacking	3 (PS) 9 (US)	3 (PS) 6 (US)
Max Cart Stacking	12 (PS) 12 (US)	30 (PS) 12 (US)
Weight and Capacity		
Weight	15 lb	14.5 lb
Weight Capacity Warranty	300 lb	300 lb

Plastic seat (PS). Upholstered seat (US).

STOOL SPECIFICATIONS

Model:	1101 FT2 S9 Wire Rod Counter Stool	1101 FT2 S2 Wire Rod Bar Stool
Dimensions		
Overall Width	21.5"	22"
Overall Depth	20.25"	22.9"
Overall Height	39.5"	45.75"
Seat Width	17.5"	17.5"
Seat Depth	16.75"	16.75"
Seat Height	24.25"	30.25"
Back Width	16.25"	16.25"
Back Height	16.25"	16.25"
Materials		
COM	0.85 yd	0.85 yd
Stacking		
Max Floor Stacking	3 (PS) 3 (US)	3 (PS) 3 (US)
Max Cart Stacking	N/A	N/A
Weight and Capacity		
Weight	18 lb	19.5 lb
Weight Capacity Warranty	300 lb	300 lb

Plastic seat (PS). Upholstered seat (US).

Movi

NESTER CHAIR

Lean back. Nest easy.

Meet the last nester you'll ever need. Whether you're setting up, breaking down or making space for spontaneous collaboration, today's modern workplace calls for high-design seating solutions that can keep up with it all.

Enter Movi: our ultra-lightweight nester with a slim, modern frame and extra flexibility built right in for long-range comfort all day long.



*Mesh-back
Featured with aqua mesh and
SitOnIt Seating's Dash – Dove*

EFFECTIVE NOVEMBER 4, 2024

Featured Models

ARMLESS MESH-BACK :: \$757

Mesh back, upholstered seat in grade 1 textile, black frame and base, armless, carpet casters

MESH-BACK :: \$841

Mesh back, upholstered seat with grade 1 textile, white frame and base, fixed arms, carpet casters

UPHOLSTERED BACK :: \$962

Multi-upholstery, upholstered seat in grade 2 vinyl, upholstered back in grade 1 textile, fog frame and base, fixed arms, casters

Features

- Flexes at the hip 14 degrees for enhanced comfort
- Clean-out space for easy maintenance
- Bleach-cleanable mesh back (10:1)
- Upholstered back with outer plastic shell offers essential durability + cleanability
- 15,000+ textiles including bleach cleanable, multi-upholstery and more
- 12 breathable mesh options offer cool comfort
- Three base frame and caster colors
- Three back frame and arm colors
- Carpet, hard floor and carpet casters available
- 300 lb weight capacity warranty
- Movi nester complements Movi light task chair and stool; see [page 122](#)

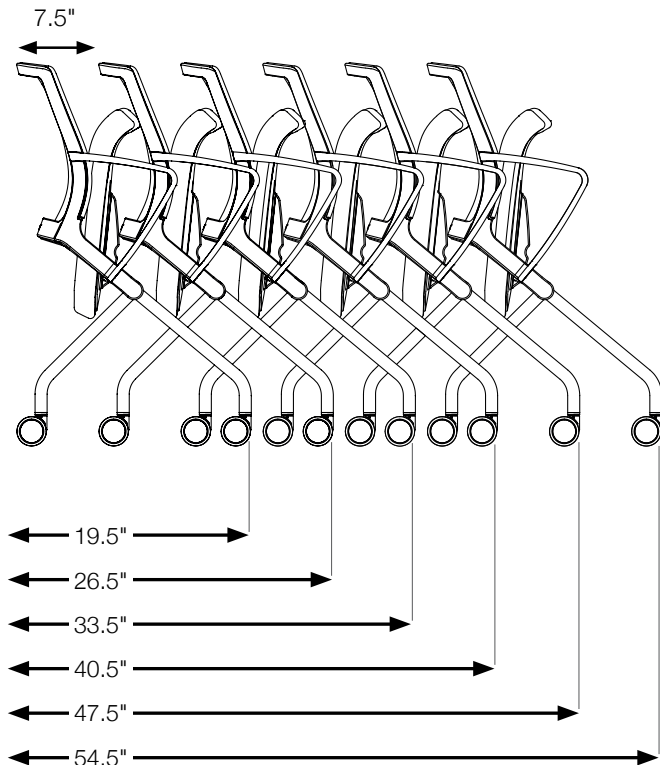

NESTER CHAIR

1. Model

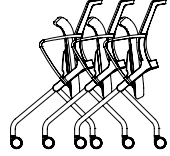
Back Material	Code	Price	
Nester	1061 FT4	\$806	

2. Back

Back Material	Code	Price	
Mesh Back	MB	+ \$0	

Upholstered Back	UB	+ \$39	
------------------	----	--------	---

Back Frame Finish	Code	Price	
Black	SC1	+ \$0	
Fog	SC27	+ \$35	
White	SC26	+ \$35	

3. Arms

Arm Style	Code	Price	
Armless	AR0	- \$49	

Fixed Loop Arms	AR1	+ \$0	
-----------------	-----	-------	---

Arms (AR1) will match back frame color.

4. Base

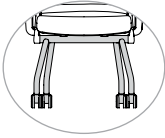
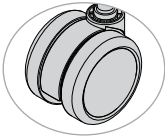
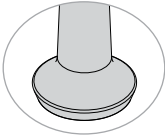
Base Frame and Caster Color	Code	Price	
Black Base With Black Casters	FC1	+ \$0	
Silver Base With Fog Casters	FC2	+ \$0	
White Base With Fog/White Casters	FC12	+ \$0	
Castors or Glides	Code	Price	
Castors			
Carpet Castors	CS5	+ \$0	
Hard Floor and Carpet Castors	CS6	+ \$40	
Glides			
Bell Glides (Black)	CS20	+ \$30	

5. Material

Protection	Code	Price	
Fire Retardancy			
CAL 133, Fabric, Quantities 1-49	133F	+ \$99	
CAL 133, Fabric, Quantities 50+	133F5	+ \$55	
Mesh Color	Code	Price	
Apple	MC31	+ \$0	
Aqua	MC30	+ \$0	
Desert	MC22	+ \$0	
Electric Blue	MC24	+ \$0	
Fire	MC25	+ \$0	
Fog	MC23	+ \$0	
Grape	MC26	+ \$0	
Lemon	MC27	+ \$0	
Nickel	MC21	+ \$0	
Ocean	MC29	+ \$0	
Onyx	MC20	+ \$0	
Tangerine	MC28	+ \$0	

NESTER CHAIR

5. Material (Cont.)

Fully Upholstered	Code	Price	
Mesh Back (Seat Only)			
Fabric/Vinyl Grade 1	FG1/VG1	+ \$0	
COM	COM	+ \$24	
Fabric/Vinyl Grade 2	FG2/VG2	+ \$24	
Fabric/Vinyl Grade 3	FG3/VG3	+ \$45	
Fabric/Vinyl Grade 4	FG4/VG4	+ \$77	
Fabric/Vinyl Grade 5	FG5/VG5	+ \$116	
Fabric/Vinyl Grade 6	FG6/VG6	+ \$159	
Fabric/Vinyl Grade 7	FG7/VG7	+ \$200	



Upholstered Back
 Featured with SitOnIt Seating's Slide — Electric Blue
 and SitOnIt Seating's Malibu — Cobalt

5. Material (Cont.)

Fully Upholstered	Code	Price
Upholstered Back (Seat and Back)		
Fabric/Vinyl Grade 1	FG1/VG1	+ \$0
COM	COM	+ \$36
Fabric/Vinyl Grade 2	FG2/VG2	+ \$36
Fabric/Vinyl Grade 3	FG3/VG3	+ \$74
Fabric/Vinyl Grade 4	FG4/VG4	+ \$121
Fabric/Vinyl Grade 5	FG5/VG5	+ \$174
Fabric/Vinyl Grade 6	FG6/VG6	+ \$235
Fabric/Vinyl Grade 7	FG7/VG7	+ \$296
Multi-Upholstery	Code	Price
Multi-Upholstery Upcharge	UMU	+\$58
Seat Upholstery Only		
Fabric/Vinyl Grade 1	FG1/VG1	+ \$0
COM	COM	+ \$24
Fabric/Vinyl Grade 2	FG2/VG2	+ \$24
Fabric/Vinyl Grade 3	FG3/VG3	+ \$45
Fabric/Vinyl Grade 4	FG4/VG4	+ \$77
Fabric/Vinyl Grade 5	FG5/VG5	+ \$116
Fabric/Vinyl Grade 6	FG6/VG6	+ \$159
Fabric/Vinyl Grade 7	FG7/VG7	+ \$200
Back Upholstery Only		
Fabric/Vinyl Grade 1	FG1/VG1	+ \$0
COM	COM	+ \$20
Fabric/Vinyl Grade 2	FG2/VG2	+ \$20
Fabric/Vinyl Grade 3	FG3/VG3	+\$39
Fabric/Vinyl Grade 4	FG4/VG4	+\$63
Fabric/Vinyl Grade 5	FG5/VG5	+\$91
Fabric/Vinyl Grade 6	FG6/VG6	+\$123
Fabric/Vinyl Grade 7	FG7/VG7	+\$154

Please reference the [Textile Reference Guide](#) for pricing on fabric over grade 7. Additional CAL 133 information can be found on [page 15](#).

6. Packaging

Packaging	Code	Price
Fully Assembled In a Carton	AC	+ \$0
Assembled in Bag (Southern California Only)	AB	+ \$0

NESTER CHAIR

SPECIFICATIONS

Model:	1061 FT4 Nester Chair
Dimensions	
Overall Width With Arms	23"
Overall Width Armless	21"
Overall Depth	22.75"
Overall Height	34.5" (MB), 34.75" (UB)
Seat Width	19"
Seat Depth	17"
Seat Height	18"
Back Width	18"
Back Height	18" (MB), 18.25" (UB)
Materials	
COM (Back)	1 yd
COM (Seat)	1 yd
COM (Seat and Back)	1.25 yd
Weight and Capacity	
Weight With Arms	20 lb (MB), 25 lb (UB)
Weight Armless	19 lb (MB), 24 lb (UB)
Weight Capacity Warranty	300 lb

Meshback (MB), Upholstered Back (UB)

OnCall

MULTIPURPOSE CHAIR AND BAR STOOL

*High performance,
low maintenance.*

Practical, solid wire frame design and stackability make OnCall™ ideal for multipurpose use. It's a value-priced solution for meeting rooms and break areas as well as labs and educational environments. The plastic model offers value while upholstered models ensure a more comfortable sit. A half-circle back cutout serves as a handle to move the side chair or stool anywhere.



Good
Featured with a Navy shell

EFFECTIVE NOVEMBER 4, 2024

Featured Models

GOOD :: \$241

Wire rod chair, all plastic, armless

BETTER :: \$306

Wire rod chair, upholstered seat and plastic back, armless, grade 1 textile



BEST :: \$429

Wire rod chair, upholstered seat and back, fixed arms, grade 1 textile

Features

- Fully upholstered, upholstered seat or plastic
- Three plastic colors
- Black or chrome frame
- Chair stacks eight on the floor, 20-25 on the optional cart; bar stool stacks four on the floor
- Built-in pull handle
- Wall-saver frame design
- 250 lb weight capacity warranty
- Complements OnCall light task chair and stool; see [page 141](#)

1. Back

Back and Seat Style	Code	Price	
Plastic	No Code	\$241	
Upholstered Seat Only	US	\$306	
Upholstered Seat and Back	UP	\$371	

2. Frame

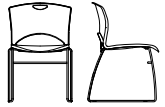
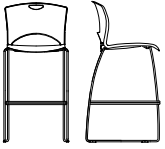

Frame Type	Code	Price	
Wire Rod Side Chair	90	+ \$0	
30" Wire Rod Bar Stool	90 S2	+ \$150	

MULTIPURPOSE CHAIR AND BAR STOOL

2. Frame (Cont.)

Frame Finish	Code	Price	
Black	SB	+ \$0	
Chrome	SC	+ \$0	

3. Arms



Arm Style	Code	Price	
Armless	A0	+ \$0	
Fixed Cantilever	A37	+ \$58	

Fixed cantilever arms (A37) are not available on the bar stool (90 S2).

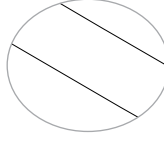
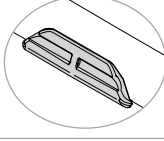
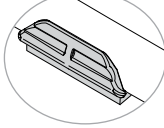
4. Base

Glides	Code	Price	
No Glides	N	+ \$0	
Clear Glides	CG	+ \$9	
Clear Glides With Felt	CGF	+ \$27	

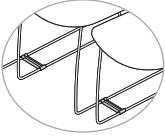
5. Miscellaneous

Accessories	Code	Price	
Ganging Bracket for Armless Models	GG3	+ \$30	
Ganging Bracket for Models With Arms	GA3	+ \$30	
Stacking Cart	Cart	+ \$399	

Stacking carts require assembly.

Ganging brackets and stacking carts are not intended for use with wire rod bar stool (S2) models and are compatible with side chair only.

See [page 630](#) for additional stacking requirements.

6. Material

Protection	Code	Price	
Fire Retardancy			
CAL 133, Fabric, Quantities 1-49	133F	+ \$99	
CAL 133, Fabric, Quantities 50+	133F5	+ \$55	
CAL 133, Plastic, Any Quantity	133P	+ \$45	
Shell Color			
Black	SC1	+ \$0	
Navy	SC5	+ \$0	
Slate	SC8	+ \$0	
Textile			
Seat Only (For US)			
Fabric/Vinyl Grade 1	FG1/VG1	+ \$0	
COM	COM	+ \$24	
Fabric/Vinyl Grade 2	FG2/VG2	+ \$24	
Fabric/Vinyl Grade 3	FG3/VG3	+ \$45	
Fabric/Vinyl Grade 4	FG4/VG4	+ \$77	
Fabric/Vinyl Grade 5	FG5/VG5	+ \$116	
Fabric/Vinyl Grade 6	FG6/VG6	+ \$159	
Fabric/Vinyl Grade 7	FG7/VG7	+ \$200	

MULTIPURPOSE CHAIR AND BAR STOOL

6. Material

Textile (Cont.)	Code	Price	
Seat and Back (For UP)			
Fabric/Vinyl Grade 1	FG1/VG1	+ \$0	
COM	COM	+ \$36	
Fabric/Vinyl Grade 2	FG2/VG2	+ \$36	
Fabric/Vinyl Grade 3	FG3/VG3	+ \$74	
Fabric/Vinyl Grade 4	FG4/VG4	+ \$121	
Fabric/Vinyl Grade 5	FG5/VG5	+ \$174	
Fabric/Vinyl Grade 6	FG6/VG6	+ \$235	
Fabric/Vinyl Grade 7	FG7/VG7	+ \$296	

Please reference the [Textile Reference Guide](#) for pricing on fabric over grade 7. Additional CAL 133 information can be found on [page 15](#).

7. Packaging

Packaging	Code	Price	
Fully Assembled Chairs In a Carton	AC4	+ \$0	
Fully Assembled Stools In a Carton	AC4	+ \$0	
Fully Assembled Chairs In a Carton, Individually Packaged	AC1	+ \$20	

An additional charge will apply for each additional chair in the AC1 packaging.



EFFECTIVE NOVEMBER 4, 2024 | GSA SIN #: 33721

SPECIFICATIONS

Model:	90 Wire Rod Multipurpose Chair	90 S2 30" Wire Rod Bar Stool
Dimensions		
Overall Width Armless	20"	20"
Overall Width With Arms	24.5"	24.5"
Overall Depth	22.5"	23"
Overall Height	31"	43.5"
Seat Width	18"	18"
Seat Depth	17.5"	17.5"
Seat Height	17.5"	29.5"
Back Width	19.5"	19.5"
Back Height	15"	15"
Materials		
COM	0.8 yd (US) 0.85 yd (UP)	0.8 yd (US) 0.85 yd (UP)
Stacking		
Max Cart Stacking Armless	25 (Plastic) N/A (Upholstered)	N/A
Max Cart Stacking W/with Arms	20 (Plastic) N/A (Upholstered)	N/A
Max Floor Stacking Armless	8 (Plastic) N/A (Upholstered)	4
Max Floor Stacking W/with Arms	8 (Plastic) N/A (Upholstered)	N/A
Weight and Capacity		
Weight Armless	11.4 lb (Plastic) 12.4 lb (US)	21.2 lb (Plastic) 22.2 lb (US)
Weight With Arms	14.2 lb (Plastic) 15.2 lb (US)	N/A
Weight Capacity Warranty	250 lb	250 lb

Upholstered seat only (US). Upholstered seat and back (UP). Stacking upholstered



*Best
Featured with a Black shell and SitOnIt Seating's Sugar – Apple*

Orbix

MULTIPURPOSE CHAIR AND BAR STOOL

Everything you need (and more).

More design in a stacker. More comfort in a sit. More models to match the needs of any space. The robust build of Orbix® features an ultra-supportive and extra-wide backrest with hundreds of diamond-cut perforations for unmatched breathability and the comfort to breeze through safe and distanced get-togethers. It sets up quickly, stacks up easily, and stores away conveniently.



Good
Featured with a Navy shell

Featured Models

GOOD :: \$227

Multipurpose chair, plastic seat and back, armless, no glides

BETTER :: \$301

Multipurpose chair, upholstered seat, plastic back, armless, clear glides, grade 1 textile



BEST :: \$377

Multipurpose chair, upholstered seat, plastic back, fixed arms, clear glides with felt, grade 1 textile

Features

- Consistent, cohesive look with a broad statement of line offers options to fit any space
- Upscale stacking chair with bold lines and striking detail
- Ultra-supportive, extra-wide backrest provides lasting comfort
- Hundreds of diamond-cut perforations offer unmatched breathability and visual transparency
- Integrated clean-out makes it easy to wipe down, set up, stack and store away
- Collection options include wire rod, bar stool, light task chair and stool; see [page 145](#) for Orbix light task chair and stool;
- Plastic wire rod stacks six on the floor (25 on a cart); plastic bar stool stacks six on the floor
- Black or chrome frame finish and 14 shell colors coordinate with optional arm pads and upholstered seat

1. Frame

Frame Type	Code	Price	
Wire Rod Chair	1131 FT2	\$227	
30" Bar Stool	1131 FT2 S2	\$377	
Frame Type	Code	Price	
Black	FC1	+ \$0	
Chrome	FC15	+ \$0	

MULTIPURPOSE CHAIR AND BAR STOOL

2. Seat and Back

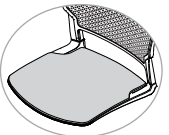
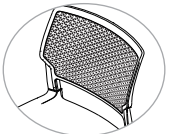
Seat Style	Code	Price	
Plastic	PS	+ \$0	
Upholstered	US	+ \$65	
Back Style	Code	Price	
Plastic	PB	+ \$0	

Do not stack upholstered chairs.



*Best
Featured with a Pacific shell and
SitOnIt Seating's Huntington — Night*

3. Arms

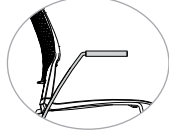
Arm Style	Code	Price	
Armless	AR0	+ \$0	
Fixed	AR1	+ \$58	

Available on wire rod chairs only.

4. Base

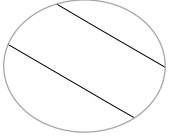
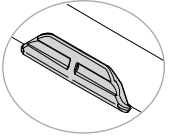
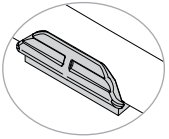
Glides	Code	Price	
No Glides	G0	+ \$0	
Clear Glides	CGR	+ \$9	
Clear Glides With Felt	CGRF	+ \$27	

5. Miscellaneous

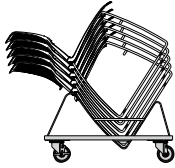
Accessories	Code	Price	
Ganging Bracket for Armless Models	GG	+ \$30	
Ganging Bracket for Models With Arms	GA	+ \$30	
Stacking Cart	CART	+ \$399	

Stacking carts require assembly.
See [page 630](#) for additional stacking requirements.

MULTIPURPOSE CHAIR AND BAR STOOL

6. Material

Shell Color	Code	Price	
Apple	SC24	+ \$0	
Arctic	SC21	+ \$0	
Bisque	SC7	+ \$0	
Black	SC1	+ \$0	
Chocolate	SC4	+ \$0	
Latte	SC20	+ \$0	
Lagoon	SC15	+ \$0	
Lemon	SC25	+ \$0	
Navy	SC5	+ \$0	
Pacific	SC22	+ \$0	
Red	SC19	+ \$0	
Slate	SC8	+ \$0	
Sterling	SC18	+ \$0	
Tangerine	SC23	+ \$0	

Seat Textile	Code	Price	
Fabric/Vinyl Grade 1	FG1/VG1	+ \$0	
COM	COM	+ \$24	
Fabric/Vinyl Grade 2	FG2/VG2	+ \$24	
Fabric/Vinyl Grade 3	FG3/VG3	+ \$45	
Fabric/Vinyl Grade 4	FG4/VG4	+ \$77	
Fabric/Vinyl Grade 5	FG5/VG5	+ \$116	
Fabric/Vinyl Grade 6	FG6/VG6	+ \$159	
Fabric/Vinyl Grade 7	FG7/VG7	+ \$200	

Please reference the [Textile Reference Guide](#) for pricing on fabric over grade 7 and leather over grade 3. Additional CAL 133 information can be found on [page 15](#).

7. Packaging

Packaging	Code	Price	
Fully Assembled In a Carton	AC	+ \$0	
Fully Assembled In a Carton, Individually Packaged	AC1	+ \$20	

EFFECTIVE NOVEMBER 4, 2024 | GSA SIN #: 33721

SPECIFICATIONS

	1131 FT2 Wire Rod Chair	1131 FT2 S2 Bar Stool
Dimensions		
Overall Width Armless	20"	20"
Overall Width With Arms	24.75"	N/A
Overall Depth	21.75"	22.5"
Overall Height	33.25"	45.5"
Seat Width	18.25"	18.25"
Seat Depth	17.25"	17.25"
Seat Height	18"	30"
Back Width	19.75"	19.75"
Back Height	17.5"	17.5"
Materials		
COM	0.75 yd	0.75 yd
Stacking		
Max Cart Stacking	25 (PS)	N/A
Max Floor Stacking	6 (PS)	6 (PS)
Weight and Capacity		
Weight Armless	13 lb (PS) 14 lb (US)	21 lb (PS) 22 lb (US)
Weight With Arms	16 lb (PS) 17 lb (US)	N/A
Weight Capacity Warranty	300 lb	300 lb

Plastic seat (PS). Upholstered seat (US).



*Better
Featured with a Slate shell*

Qwiz

NESTER CHAIR

Nest brilliantly.

From classrooms to training rooms, the need to get in groups can pop up without warning – and Qwiz® is the perfect answer. It's a smart, fun and versatile nester that makes coming together for collaboration or leaving the room with inspiration quick, easy and comfortable.



Mesh
Featured with a Lemon mesh and
SitOnIt Seating's Dash – Dove

EFFECTIVE NOVEMBER 4, 2024

Featured Models

PLASTIC :: \$496

Plastic seat and back, armless, black shell and frame, carpet casters

MESH :: \$629

Upholstered seat, mesh back, armless, white shell and frame, carpet casters, grade 1 textile

UPHOLSTERED :: \$691

Upholstered seat and back, fog shell and frame, fixed arms, carpet casters, grade 1 textile

Features

- Caster design and flip-up seat for high-density nesting
- Perforated seat and back for breathability
- Three shell and frame colors
- 12 bleach-cleanable mesh back colors
- Upholstered seat or fully upholstered
- Interlocking system for easy ganging
- Available as an armless option
- Performance casters and standard multi-surface glides available
- 300 lb weight capacity warranty

1. Frame

Frame Type	Code	Price	
Nesting	1141 FT4	\$526	

Shell and Frame Finish	Code	Price	
Black	SC1	+ \$0	
Fog	SC27	+ \$35	
White	SC26	+ \$35	

2. Seat

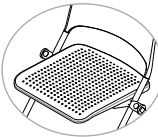
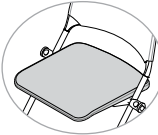
Seat Style	Code	Price	
Plastic Seat	PS	+ \$0	
Upholstered Seat	US	+ \$65	

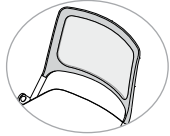
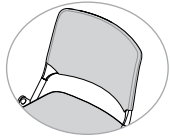

NESTER CHAIR

3. Back

Back Style	Code	Price	
Plastic Back	PB	+ \$0	
Mesh Back	MB	+ \$33	
Upholstered Back	UB	+ \$65	

Upholstered back (UB) is only available with upholstered seat (US).

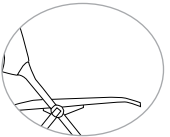
4. Arms

Arm Style	Code	Price	
Armless	AR0	- \$30	
Fixed	AR1	+ \$0	

Arm caps will match shell color.

5. Base

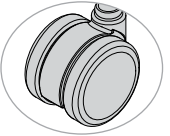
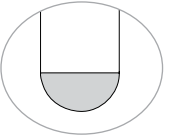
Casters or Glides	Code	Price	
Casters			
Carpet Casters	CS5	+ \$0	
Hard Floor and Carpet Casters	CS6	+ \$40	
Glides			
Standard Multi-Surface Glides	GL1	+ \$30	

Casters, glides and interlock system are black for black shell and frame (SC1) and fog for both fog (SC27) or white (SC26) shells and frames.

6. Material

Mesh Color (For MB)	Code	Price	
Apple	MC31	+ \$0	
Aqua	MC30	+ \$0	
Desert	MC22	+ \$0	
Electric Blue	MC24	+ \$0	
Fire	MC25	+ \$0	
Fog	MC23	+ \$0	
Grape	MC26	+ \$0	
Lemon	MC27	+ \$0	
Nickel	MC21	+ \$0	
Ocean	MC29	+ \$0	
Onyx	MC20	+ \$0	
Tangerine	MC28	+ \$0	
Protection	Code	Price	
Fire Retardancy			
CAL 133, Fabric, Quantities 1-49	133F	+ \$64	
CAL 133, Fabric, Quantities 50+	133F5	+ \$20	
CAL 133, Plastic, Any Quantity	133P	+ \$10	

Additional CAL 133 information can be found on [page 15](#).

NESTER CHAIR

6. Material (Cont.)

Textile	Code	Price	
Seat Only (For US)			
Fabric/Vinyl Grade 1	FG1/VG1	+ \$0	
COM	COM	+ \$24	
Fabric/Vinyl Grade 2	FG2/VG2	+ \$24	
Fabric/Vinyl Grade 3	FG3/VG3	+ \$45	
Fabric/Vinyl Grade 4	FG4/VG4	+ \$77	
Fabric/Vinyl Grade 5	FG5/VG5	+ \$116	
Fabric/Vinyl Grade 6	FG6/VG6	+ \$159	
Fabric/Vinyl Grade 7	FG7/VG7	+ \$200	
Seat and Back (For UB)			
Fabric/Vinyl Grade 1	FG1/VG1	+ \$0	
COM	COM	+ \$36	
Fabric/Vinyl Grade 2	FG2/VG2	+ \$36	
Fabric/Vinyl Grade 3	FG3/VG3	+ \$74	
Fabric/Vinyl Grade 4	FG4/VG4	+ \$121	
Fabric/Vinyl Grade 5	FG5/VG5	+ \$174	
Fabric/Vinyl Grade 6	FG6/VG6	+ \$235	
Fabric/Vinyl Grade 7	FG7/VG7	+ \$296	

Please reference the [Textile Reference Guide](#) for pricing on fabric over grade 7.

Due to the nature of vinyl upholstery, nesting may cause impressions on the seat. SitOnIt Seating does not warrant the effects of nesting on vinyl upholstery.

7. Packaging

Packaging	Code	Price	
Fully Assembled In a Carton	AC	+ \$0	
Fully Assembled In a Carton, Individually Packaged	AC1	+ \$20	



Plastic
Featured with a black shell

EFFECTIVE NOVEMBER 4, 2024 | GSA SIN #: 33721

SPECIFICATIONS

Model:	1141 FT4 Nester
Dimensions	
Overall Width With Arms	22"
Overall Width Armless	22"
Overall Depth	22.5"
Overall Height	32"
Seat Width	16.4"
Seat Depth	17"
Seat Height	17.75" (PS) 18" (US/UB)
Back Width	18.5"
Back Height	15"
Arm Height	25.5"
Materials	
COM	0.75 yd (US) 1 yd (US/UB)
Weight and Capacity	
Weight With Arms	15 lb
Weight Armless	13 lb
Weight Capacity Warranty	300 lb

Plastic seat (PS). Upholstered seat only (US). Upholstered seat and back (US/UB).

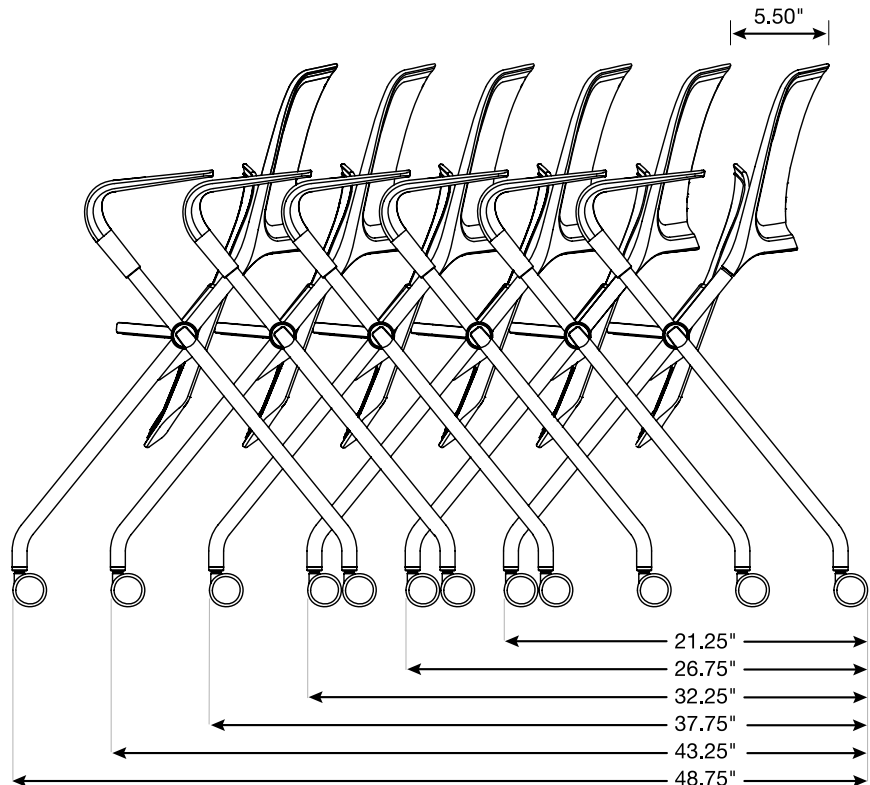

Relay

MULTIPURPOSE CHAIR

Durable and adaptable to the finish.

Great to look at, Relay provides lasting comfort in a stylish design that makes an appealing multipurpose seating option for meeting, training, conference and break rooms. The seat and back are molded from high-impact thermoplastic for lasting durability and comfort. Add the optional upholstered seat and back for a more sophisticated, inviting look and added comfort. Relay side chairs are available in black or silver frame with a caster option.



Good
Featured with a Lagoon shell

EFFECTIVE NOVEMBER 4, 2024

Featured Models

GOOD :: \$390

All plastic, armless, standard multi-surface glides

BETTER :: \$455

Plastic back, upholstered seat, armless, standard multi-surface glides, grade 1 textile

BEST :: \$618

Upholstered seat and back, fixed cantilever arms, casters, grade 1 textile

Features

- Structurally reinforced and durable back
- High-impact polypropylene
- Fully upholstered, upholstered seat or plastic
- Nine plastic colors
- 4-leg frame
- Armless or with fixed cantilever arms
- Stacks five on the floor, five on the optional cart
- Black or silver frame
- Wall-saver frame design
- 250 lb weight capacity warranty
- Complements Relay light task chair and stool; see [page 161](#)

1. Back

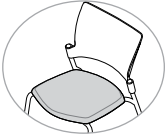
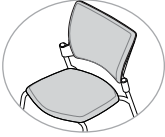

Back and Seat Style	Code	Price	
Plastic	No Code	\$390	
Upholstered Seat Only	US	\$455	
Upholstered Seat and Back	UP	\$520	

MULTIPURPOSE CHAIR

2. Frame

Frame Type and Finish	Code	Price	
Black, 4-Leg	94FB	+ \$0	
Silver, 4-Leg	94FS	+ \$0	
Black, 4-Leg With Black Carpet Casters	94FCB	+ \$40	
Silver, 4-Leg With Black Carpet Casters	94FCS	+ \$40	

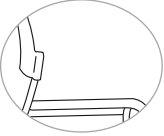
3. Arms

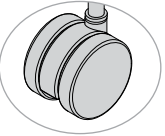
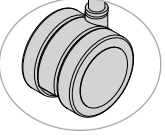
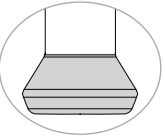

Arm Style	Code	Price	
Armless	A0	+ \$0	
Fixed Cantilever	A60	+ \$58	

4. Base

Casters or Glides	Code	Price	
Casters (For 94FCB / 94FCS)			
Carpet Casters	C13	+ \$0	
Hard Floor and Carpet Casters	C12	+ \$40	
Glides (For 94FB / 94FS)			
Standard Multi-Surface Glides	G9	+ \$0	

Please use caution when stacking models with casters to prevent frame damage. SitOnIt Seating does not warrant scratched frames.

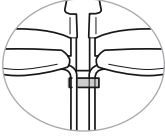
5. Miscellaneous

Accessories	Code	Price	
Ganging Bracket for Armless Models	GG2	+ \$30	
Ganging Bracket for Models With Arms	GA2	+ \$30	
Stacking Cart	14-Cart	+ \$399	

Ganging brackets and stacking carts are not intended for use with caster models and are compatible with glides only. See page 630 for additional stacking requirements.

Due to the nature of upholstery, stacking may cause impressions on the seat. SitOnIt Seating does not warrant the effects of stacking on upholstery.

6. Material

Protection	Code	Price	
Fire Retardancy			
CAL 133, Fabric, Quantities 1-49	133F	+ \$99	
CAL 133, Fabric, Quantities 50+	133F5	+ \$55	
CAL 133, Plastic, Any Quantity	133P	+ \$45	
Shell Color	Code	Price	
Arctic	SC21	+ \$0	
Black	SC1	+ \$0	
Chocolate	SC4	+ \$0	
Lagoon	SC15	+ \$0	
Latte	SC20	+ \$0	
Navy	SC5	+ \$0	
Red	SC19	+ \$0	
Slate	SC8	+ \$0	
Sterling	SC18	+ \$0	
Textile	Code	Price	
Seat Only (US)			
Fabric/Vinyl Grade 1	FG1/VG1	+ \$0	
COM	COM	+ \$24	
Fabric/Vinyl Grade 2	FG2/VG2	+ \$24	
Fabric/Vinyl Grade 3	FG3/VG3	+ \$45	
Fabric/Vinyl Grade 4	FG4/VG4	+ \$77	
Fabric/Vinyl Grade 5	FG5/VG5	+ \$116	
Fabric/Vinyl Grade 6	FG6/VG6	+ \$159	
Fabric/Vinyl Grade 7	FG7/VG7	+ \$200	

MULTIPURPOSE CHAIR

6. Material (Cont.)

Textile	Code	Price	
Seat and Back (UP)			
Fabric/Vinyl Grade 1	FG1/VG1	+ \$0	
COM	COM	+ \$36	
Fabric/Vinyl Grade 2	FG2/VG2	+ \$36	
Fabric/Vinyl Grade 3	FG3/VG3	+ \$74	
Fabric/Vinyl Grade 4	FG4/VG4	+ \$121	
Fabric/Vinyl Grade 5	FG5/VG5	+ \$174	
Fabric/Vinyl Grade 6	FG6/VG6	+ \$235	
Fabric/Vinyl Grade 7	FG7/VG7	+ \$296	

Please reference the [Textile Reference Guide](#) for pricing on fabric over grade 7.

7. Packaging

Packaging	Code	Price	
Fully Assembled in Carton	AC4	+ \$0	
Individually Packaged	AC1	+ \$20	

SPECIFICATIONS

Model:	94F 4-Leg Multipurpose Chair	94FC 4-Leg Multipurpose Chair With Casters
Dimensions		
Overall Width Armless	21.125"	21.125"
Overall Width With Arms	25.75"	25.75"
Overall Depth	22"	22"
Overall Height	33.5"	33.5"
Seat Width	18.25"	18.25"
Seat Depth	17"	17"
Seat Height	18" (Plastic) 19" (US/UP)	18" (Plastic) 19" (US/UP)
Back Width	19.125"	19.125"
Back Height	17"	17"
Materials		
COM	0.75 yd (US) 1 yd (UP)	0.75 yd (US) 1 yd (UP)
Stacking		
Max Cart Stacking	5	N/A
Max Floor Stacking	5	N/A
Weight and Capacity		
Weight Armless	13.5 lb	14 lb
Weight With Arms	14.5 lb	15 lb
Weight Capacity Warranty	250 lb	250 lb

Upholstered seat only (US). Upholstered seat and back (UP).

Relay

NESTER CHAIR

Durable and adaptable to the finish.

Great to look at, Relay provides lasting comfort in a stylish design that makes an appealing multipurpose seating option for meeting, training, conference and break rooms. The seat and back are molded from high-impact thermoplastic for lasting durability and comfort. Add the optional upholstered seat and back for a more sophisticated, inviting look and added comfort. Relay nesting chairs are available in black or silver frame and come with casters standard.



Featured Models

GOOD :: \$429

All plastic, armless, casters

BETTER :: \$494

Plastic back, upholstered seat, armless, casters, grade 1 textile



BEST :: \$617

Upholstered seat and back, fixed cantilever arms, casters, grade 1 textile

Features

- Structurally reinforced and durable back
- High-impact polypropylene
- Fully upholstered, upholstered seat or plastic
- Nine plastic colors
- Armless or with fixed cantilever arms
- Black or silver frame
- 17 chairs in 10 feet of space
- Wall-saver frame design
- 250 lb weight capacity
- Complements Relay light task chair and stool; see [page 161](#)

1. Back



Back and Seat Style	Code	Price	
Plastic	No Code	\$429	
Upholstered Seat Only	US	\$494	
Upholstered Seat and Back	UP	\$559	

2. Frame

Frame Finish	Code	Price	
Black With Black Carpet Casters	94XB	+\$0	
Silver With Black Carpet Casters	94XS	+\$0	

NESTER CHAIR

3. Arms

Arm Style	Code	Price	
Armless	A0	+\$0	
Fixed Cantilever	A60	+\$58	

4. Base

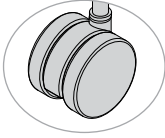
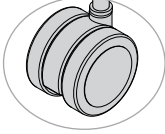
Casters	Code	Price	
Black Carpet Casters	C13	+\$0	
Hard Floor and Carpet Casters	C12	+\$40	

5. Miscellaneous

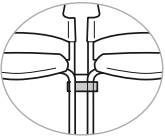
Accessories	Code	Price	
Ganging Bracket for Nester Models	GA10	+\$30	

6. Material

Protection	Code	Price
Fire Retardancy		
CAL 133, Fabric, Quantities 1–49	133F	+ \$99
CAL 133, Fabric, Quantities 50+	133F5	+ \$55
CAL 133, Plastic, Any Quantity	133P	+ \$45
Shell Color	Code	Price
Arctic	SC21	+ \$0
Black	SC1	+ \$0
Chocolate	SC4	+ \$0
Lagoon	SC15	+ \$0
Latte	SC20	+ \$0
Navy	SC5	+ \$0
Red	SC19	+ \$0
Slate	SC8	+ \$0
Sterling	SC18	+ \$0
Textile	Code	Price
Seat Only (US)		
Fabric/Vinyl Grade 1	FG1/VG1	+ \$0
COM	COM	+ \$24
Fabric/Vinyl Grade 2	FG2/VG2	+ \$24
Fabric/Vinyl Grade 3	FG3/VG3	+ \$45
Fabric/Vinyl Grade 4	FG4/VG4	+ \$77
Fabric/Vinyl Grade 5	FG5/VG5	+ \$116
Fabric/Vinyl Grade 6	FG6/VG6	+ \$159
Fabric/Vinyl Grade 7	FG7/VG7	+ \$200
Seat and Back (UP)		
Fabric/Vinyl Grade 1	FG1/VG1	+ \$0
COM	COM	+ \$36
Fabric/Vinyl Grade 2	FG2/VG2	+ \$36
Fabric/Vinyl Grade 3	FG3/VG3	+ \$74
Fabric/Vinyl Grade 4	FG4/VG4	+ \$121
Fabric/Vinyl Grade 5	FG5/VG5	+ \$174
Fabric/Vinyl Grade 6	FG6/VG6	+ \$235
Fabric/Vinyl Grade 7	FG7/VG7	+ \$296

Please reference the [Textile Reference Guide](#) for pricing on fabric over grade 7. Additional CAL 133 information can be found on [page 15](#).

Please reference the [Fabric information](#) found on [page 17](#) for pricing on multi-upholstery.

NESTER CHAIR

7. Packaging

Packaging	Code	Price
Fully Assembled in a Carton	AC4	+ \$0
Fully Assembled in a Carton, Individually Packaged	AC1	+ \$20

SPECIFICATIONS

	94X Nester Chair
Dimensions	
Overall Width Armless	24"
Overall Width With Arms	25.75"
Overall Depth	25.25"
Overall Height	33.5"
Seat Width	18.25"
Seat Depth	17.25"
Seat Height	18.5" (Plastic) 19.5" (US/UP)
Back Width	19.125"
Back Height	17"
Weight Armless	21.5 lb
Weight With Arms	22.5 lb
Materials	
COM	0.75 yd (US) 1 yd (UP)
Weight and Capacity	
Weight Armless	21.5 lb
Weight With Arms	22.5 lb
Weight Capacity Warranty	250 lb

Upholstered seat only (US). Upholstered seat and back (UP).

Rio

MULTIPURPOSE CHAIR, COUNTER STOOL AND BAR STOOL

Design that responds to you.

What goes into the award-winning line of Rio® plastic chairs? Patented flexing technology, for one. Our complete family of Rio models feature our patented Active Rebound Control (ARC) Technology®—a performance-minded flexor insert that supports a wide range of motion (20 full degrees to be exact) and responds precisely to the amount of weight pressed against it.

Add a fresh, modern color palette and you've got a seating solution that allows for more movement, day-long comfort and flexibility than any other chair in its class.

The Rio is an easy choice for multi-use spaces that require quick setups and breakdowns. Discover a collection of stackable chairs engineered to allow for better movement, applications across more environments and a longer product life.



Good
Featured with a Lemon shell

EFFECTIVE NOVEMBER 4, 2024

Featured Models

GOOD :: \$290

4-leg chair, plastic seat and back, armless, standard multi-surface glides

BETTER :: \$355

4-leg chair, plastic back, upholstered seat, armless, standard multi-surface glides, grade 1 textile



BEST :: \$478

4-leg chair, upholstered seat and back, fixed arms, standard multi-surface glides, grade 1 textile

Features

- 4-leg, wire rod, 24" counter or 30" bar stool
- Exceptional support and comfort
- Fully upholstered, upholstered seat or plastic
- ARC Technology® for weight-assisted flex
- 14 plastic shell colors
- All models offer two frame finishes with matching arm pads
- Left or right folding tablet arm that match the frame finish.
- Easy-grip edge that acts as pull handle
- Clean-out space
- 4-Leg plastic model stacks four on the floor; eight on the optional cart
- Plastic wire rod model stacks six on the floor; 15 on the optional cart
- 300 lb weight capacity warranty
- Complements Rio light task chair and stool; see [page 165](#)

1. Frame

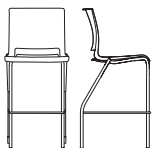
Frame Type	Code	Price	
Wire Rod Chair	1051 FT2	\$280	
4-Leg Chair	1051 FT1	\$290	
24" Counter Stool	1051 FT1 S9	\$440	
30" Bar Stool	1051 FT1 S2	\$440	



MULTIPURPOSE CHAIR, COUNTER STOOL AND BAR STOOL

1. Frame (Cont.)



Frame Finish	Code	Price	
Black	FC1	+ \$0	
Silver (4-Leg Frame Only FT1)	FC2	+ \$0	
Chrome (Wire Rod Frame Only FT2)	FC15	+ \$0	

Arms and glides, if selected, are black for black frames and fog for silver or chrome frames.

2. Back and Seat

Back and Seat Style	Code	Price	
Plastic	PS	+ \$0	
Upholstered Seat	US	+ \$65	
Upholstered Seat and Back	UP	+ \$130	

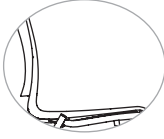
3. Arms

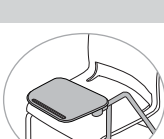
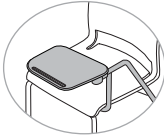
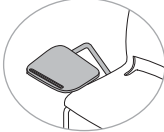
Arm Style	Code	Price	
Armless	A0	+ \$0	
Fixed Arms (4-Leg Frame Only FT1)	A91	+ \$58	
Fixed Arms (Wire Rod Frame Only FT2)	A131	+ \$58	
Tablet Arm			
Folding Tablet Arm, Left	RMTL	+ \$200	
Folding Tablet Arm, Right	RMTR	+ \$200	

Not available with wire rod (FT2) frames or stools (S9/S2). Not stackable. Tablet arm will be black for black (FC1) frame or fog for silver (FC2) frame.

4. Base

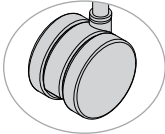
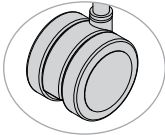
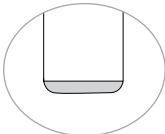
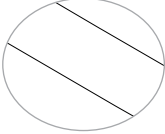
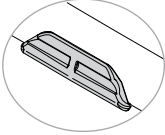
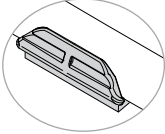
Casters or Glides	Code	Price	
Casters			
Carpet Casters	C13	+ \$40	
Hard Floor and Carpet Casters	C12	+ \$80	
Glides for 4-Leg Chair and Stool Only			
Standard Multi-Surface Glides	GL1	+ \$0	
Floor Saver Glides	GL3	+ \$20	
Steel Glides (Carpet Only)	GL4	+ \$20	
Performance Multi-Surface Glides	GL2	+ \$20	
Glides for Wire Rod Frame Only			
No Glides	G0	+ \$0	
Clear Glides	CGR	+ \$9	
Clear Glides With Felt	CGRF	+ \$27	

Please use caution when stacking models with casters to prevent frame damage. SitOnIt Seating does not warrant scratched frames.

MULTIPURPOSE CHAIR, COUNTER STOOL AND BAR STOOL

5. Miscellaneous

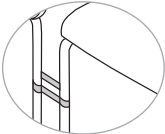
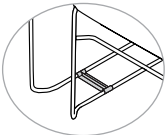
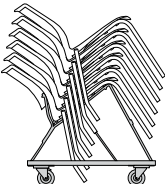
Accessories	Code	Price	
Ganging Bracket (For 4-Leg Chair FT1)	GG12	+ \$30	
Ganging Bracket (For Wire Rod Armless Models)	GG3	+ \$30	
Ganging Bracket (For Wire Rod Models With Arms)	GA4	+ \$30	
Stacking Cart	Cart	+ \$399	

Stacking carts require assembly.

Ganging brackets and stacking carts are not intended for use with caster models and are compatible with glides only. Accessories are not available for stools (S2/S9).

Due to the nature of upholstery, stacking may cause impressions on the seat. SitOnIt Seating does not warrant the effects of stacking on upholstery.

See page 630 for additional stacking requirements.

6. Material

Protection	Code	Price	
Fire Retardancy			
CAL 133, Fabric, Quantities 1-49	133F	+ \$64	
CAL 133, Fabric, Quantities 50+	133F5	+ \$20	
CAL 133, Plastic, Any Quantity	133P	+ \$10	
Shell Color			
Apple	SC24	+ \$0	
Arctic	SC21	+ \$0	
Bisque	SC7	+ \$0	
Black	SC1	+ \$0	
Chocolate	SC4	+ \$0	
Lagoon	SC15	+ \$0	
Latte	SC20	+ \$0	
Lemon	SC25	+ \$0	
Navy	SC5	+ \$0	
Pacific	SC22	+ \$0	
Red	SC19	+ \$0	
Slate	SC8	+ \$0	
Sterling	SC18	+ \$0	
Tangerine	SC23	+ \$0	

6. Material (Cont.)

Textile	Code	Price
Seat Only (US)		
Fabric/Vinyl Grade 1	FG1/VG1	+ \$0
COM	COM	+ \$24
Fabric/Vinyl Grade 2	FG2/VG2	+ \$24
Fabric/Vinyl Grade 3	FG3/VG3	+ \$45
Fabric/Vinyl Grade 4	FG4/VG4	+ \$77
Fabric/Vinyl Grade 5	FG5/VG5	+ \$116
Fabric/Vinyl Grade 6	FG6/VG6	+ \$159
Fabric/Vinyl Grade 7	FG7/VG7	+ \$200
Seat and Back (UP)		
Fabric/Vinyl Grade 1	FG1/VG1	+ \$0
COM	COM	+ \$36
Fabric/Vinyl Grade 2	FG2/VG2	+ \$36
Fabric/Vinyl Grade 3	FG3/VG3	+ \$74
Fabric/Vinyl Grade 4	FG4/VG4	+ \$121
Fabric/Vinyl Grade 5	FG5/VG5	+ \$174
Fabric/Vinyl Grade 6	FG6/VG6	+ \$235
Fabric/Vinyl Grade 7	FG7/VG7	+ \$296

Please reference the [Textile Reference Guide](#) for pricing on fabric over grade 7. Additional CAL 133 information can be found on [page 15](#).

Please reference the [Fabric](#) information found on [page 17](#) for pricing on multi-upholstery.

7. Packaging

Packaging	Code	Price
Fully Assembled In a Carton	AC	+ \$0
Fully Assembled In a Carton, Individually Packaged	AC1	+ \$20

MULTIPURPOSE CHAIR, COUNTER AND BAR STOOL

CHAIR SPECIFICATIONS

Model:	1051 FT1 4-Leg Multipurpose Chair	1051 FT2 Wire Rod Multipurpose Chair
Dimensions		
Overall Width Armless	21.2"	21.2"
Overall Width With Arms	22.2"	22.2"
Overall Depth	21.6"	23.2"
Overall Height	33.4"	33.4"
Seat Width	18.5"	18.5"
Seat Depth	18.2"	18.2"
Seat Height	17.9"	17.9"
Back Width	18.2"	18.2"
Back Height	17.5"	17.5"
Materials		
COM	0.85 yd (US) 1 yd (UP)	0.85 yd (US) 1 yd (UP)
Weight and Capacity		
Weight Armless	12.3 lb	15 lb
Weight With Arms	13.8 lb	18 lb
Weight Capacity Warranty	300 lb	300 lb

Upholstered seat only (US). Upholstered seat and back (UP).

STOOL SPECIFICATIONS

Model:	1051 FT1 S9 24" 4-Leg Counter Stool	1051 FT1 S2 30" 4-Leg Bar Stool
Dimensions		
Overall Width Armless	21.2"	21.2"
Overall Width With Arms	22.2"	22.2"
Overall Depth	22.2"	22.2"
Overall Height	40.35"	45.6"
Seat Width	18.5"	18.5"
Seat Depth	18.2"	18.2"
Seat Height	24.85"	30.1"
Back Width	18.2"	18.2"
Back Height	17.5"	17.5"
Materials		
COM	0.85 yd (US) 1 (UP)	0.85 yd (US) 1 (UP)
Weight and Capacity		
Weight Armless	17 lb	20.3 lb
Weight With Arms	18.7 lb	21.9 lb
Weight Capacity Warranty	300 lb	300 lb

Upholstered seat only (US). Upholstered seat and back (UP).

Rowdy

MULTIPURPOSE CHAIR

Value to shout about.

Rowdy is a one-piece multipurpose chair that will fit any space and any budget. Put Rowdy anywhere from meeting, training and conference rooms to auditorium and theater settings. The built-in hand-hold in the back allows easy repositioning. Stack Rowdy up to 40 high on its optional stacking cart and whisk them away for easy storage when space is at a premium.



Good
Featured with a Slate shell

EFFECTIVE NOVEMBER 4, 2024

Featured Models

GOOD :: \$194

All-plastic seat and back, armless, no glides

BETTER :: \$259

Upholstered seat, plastic back, armless, no glides, grade 1 fabric



BEST :: \$286

Upholstered seat, plastic back, clear glides with felt, grade 1 fabric

Features

- 14 plastic colors
- Built-in pull handle
- Wire-frame construction
- Black or chrome frame
- All plastic models stack 15 on the floor; 40 on the optional cart
- 250 lb weight capacity warranty

1. Seat

Seat Style	Code	Price	
Plastic	No Code	\$194	
Upholstered Seat	US	\$259	

Do not stack upholstered seats.

2. Frame

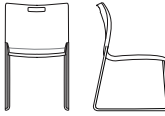
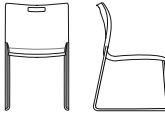

Frame Finish	Code	Price	
Black Wire Rod Base	92 SB	+ \$0	
Chrome Wire Rod Base	92 SC	+ \$0	

MULTIPURPOSE CHAIR

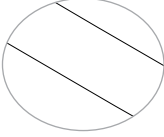

3. Arms

Arm Style	Code	Price	
Armless	A0	+ \$0	

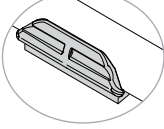
4. Base

Glides	Code	Price	
No Glides	N	+ \$0	
Clear Glides	CGR	+ \$9	
Clear Glides With Felt	CGRF	+ \$27	

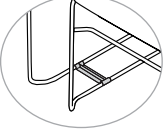
5. Miscellaneous

Accessories	Code	Price	
Ganging Bracket	GG5	+ \$30	
Stacking Cart	CART	+ \$399	

Stacking carts require assembly.

Due to the nature of upholstery, stacking may cause impressions on the seat. SitOnIt Seating does not warrant the effects of stacking on upholstery.

See page 630 for additional stacking requirements.

6. Material

Protection	Code	Price
Fire Retardancy		
CAL 133 Fabric, Quantities 1–49	133F	+ \$99

CAL 133 Fabric, Quantities 50+	133F5	+ \$55
--------------------------------	-------	--------

CAL 133 Plastic, Any Quantity	133P	+ \$45
-------------------------------	------	--------

Shell Color	Code	Price
Apple	SC24	+ \$0
Arctic	SC21	+ \$0
Bisque	SC7	+ \$0
Black	SC1	+ \$0
Chocolate	SC4	+ \$0
Lagoon	SC15	+ \$0
Latte	SC20	+ \$0
Lemon	SC25	+ \$0
Navy	SC5	+ \$0
Pacific	SC22	+ \$0
Red	SC19	+ \$0
Slate	SC8	+ \$0
Sterling	SC18	+ \$0
Tangerine	SC23	+ \$0

Seat Textile (For US)	Code	Price
Fabric/Vinyl Grade 1	FG1/VG1	+ \$0
COM	COM	+ \$24
Fabric/Vinyl Grade 2	FG2/VG2	+ \$24
Fabric/Vinyl Grade 3	FG3/VG3	+ \$45
Fabric/Vinyl Grade 4	FG4/VG4	+ \$77
Fabric/Vinyl Grade 5	FG5/VG5	+ \$116
Fabric/Vinyl Grade 6	FG6/VG6	+ \$159
Fabric/Vinyl Grade 7	FG7/VG7	+ \$200

Please reference the [Textile Reference Guide](#) for pricing on fabric over grade 7.

Stacking vinyl upholstered seat is not covered by warranty.

7. Packaging

Packaging	Code	Price
Fully Assembled in a Carton	AC4	+ \$0
Fully Assembled in a Carton, Individually Packaged	AC1	+ \$20

MULTIPURPOSE CHAIR

SPECIFICATIONS

Model:	92 Wire Rod Multipurpose Chair
Dimensions	
Overall Width	19.5"
Overall Depth	22"
Overall Height	33"
Seat Width	17"
Seat Depth	17"
Seat Height	17.5"
Back Width	19"
Back Height	16"
Materials	
COM	0.75 yd (US)
Stacking	
Max Cart Stacking Armless	40 (Plastic), N/A (Upholstered)
Max Floor Stacking Armless	15 (Plastic), N/A (Upholstered)
Weight and Capacity	
Weight Armless	13 lb
Weight Capacity Warranty	250 lb



Sprout

MULTIPURPOSE CHAIR

*It's friendly—
ergo and eco.*

The supportive, flexing back on Sprout™ provides extra ergonomics while the simple shell + frame construction makes it 100% recyclable (and super easy to maintain). It pairs a refined silhouette with rugged durability and stacks higher than any other chair we have. Whether spread out, stacked up or stored away, Sprout is always ready to thrive.



Better
Featured with the Navy shell

Featured Models

GOOD :: \$228

Plastic seat and back, armless, wire rod base, no glides

BETTER :: \$237

Plastic seat and back, armless, wire rod base, clear glides

Features

- Space-saving design features high-density stacking (up to 40 on a cart and 10 on the floor)
- Ergonomic contouring with 10-degree flexing back provides superior comfort
- Durable and simple shell + frame construction means it's easy to maintain—and is 100% recyclable when it's time to replace
- Slim lines and silhouette complement an array of environments
- Large clean-out makes clean-up quick
- Ganging option locks chairs together effortlessly, creating well-ordered rows for seating
- Nine shell colors and two frame colors
- 300 lb weight capacity warranty

1. Frame

Frame Type	Code	Price	
------------	------	-------	--

Wire Rod Chair

1181 FT2

\$228



Frame Finish	Code	Price	
--------------	------	-------	--

Black

FC1

+ \$0

Chrome

FC15

+ \$0

2. Seat and Back

Seat	Code	Price	
------	------	-------	--

Plastic

PS

+ \$0



Back	Code	Price	
------	------	-------	--

Plastic

PB

+ \$0

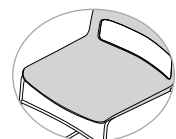

MULTIPURPOSE CHAIR

3. Arms

Arm Style	Code	Price	
-----------	------	-------	--

Armless

AR0

+\$0



4. Base

Glides	Code	Price	
--------	------	-------	--

No Glides

G0

+\$0

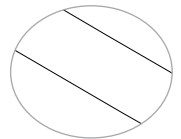

Clear Glides

CGR

+\$9

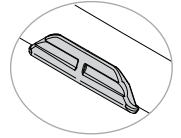

Clear Glides With Felt

CGRF

+\$27

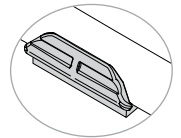

5. Miscellaneous

Accessories	Code	Price	
-------------	------	-------	--

Ganging Bracket

GG

+\$30

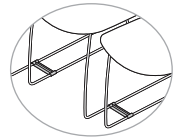

Stacking Cart

CART

+\$399

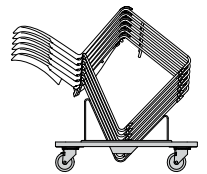

Stacking carts require assembly.

See [page 630](#) for additional stacking requirements.

MULTIPURPOSE CHAIR

6. Material

Shell Color	Code	Price
Arctic	SC21	+\$0
Black	SC1	+\$0
Chocolate	SC4	+\$0
Lagoon	SC15	+\$0
Latte	SC20	+\$0
Navy	SC5	+\$0
Red	SC19	+\$0
Slate	SC8	+\$0
Sterling	SC18	+\$0

7. Packaging

Packaging	Code	Price
Fully Assembled In a Carton	AC	+\$0
Fully Assembled in a Carton, Individually Packaged	AC1	+\$20

SPECIFICATIONS

	Wire Rod 1181 FT2
Dimensions	
Overall Width	21.25"
Overall Depth	22"
Overall Height	32"
Seat Width	18.75"
Seat Depth	16"
Seat Height	18.5"
Back Width	18.5"
Back Height	16"
Stacking	
Maximum Floor Stacking	10
Maximum Cart Stacking	40
Dimensions	
Weight	14.5 lb
Weight Capacity Warranty	300 lb



Stacking Cart

Wit Side

MESH BACK MULTIPURPOSE CHAIR

Work smarter.

A slimmer, stationary version of the task chair, our Wit Side is ideal for high-traffic settings like break rooms and cafeterias. Thanks to its ultra-lightweight frame and identical built-in pull handle, you can swing it around and rearrange spaces easily to accommodate the constant flow of crowded areas.



Good
Featured with Ocean mesh

EFFECTIVE NOVEMBER 4, 2024

Featured Models

GOOD :: \$382

Mesh back, plastic seat, armless, standard multi-surface glides

BETTER :: \$489

Mesh back, upholstered seat, fixed arms, standard multi-surface glides, grade 1 textile

BEST :: \$529

Mesh back, upholstered seat, fixed arms, carpet casters, grade 1 textile

Features

- Complements Wit task chair and Wit task stool
- Upholstered seat or plastic seat in three colors
- 12 mesh back colors
- Built-in pull handle
- Black or silver frame
- Wall-saver frame design
- Textured arm pads
- Stacks four on the floor, four on the optional cart
- Choose from two caster types and four glide options
- 300 lb weight capacity warranty
- Complements by Wit task chair and stool; see [page 192](#) and [page 196](#)

1. Frame

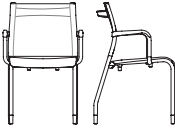
Frame Type	Code	Price	
4-Leg Side	2221 FT1 MB	\$489	

Frame Finish	Code	Price	
Black	FC1	+ \$0	
Silver	FC2	+ \$0	

2. Seat

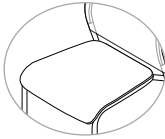
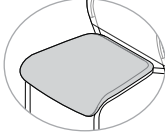
Seat Style	Code	Price	
Plastic Seat	PS	- \$58	
Upholstered Seat	US	+ \$0	

MESH BACK MULTIPURPOSE CHAIR

3. Arms

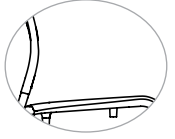
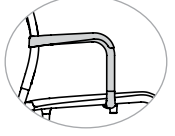
Arm Style	Code	Price	
Armless	AR0	- \$49	
Fixed Loop	AR1	+ \$0	

4. Base

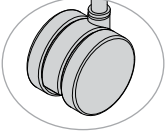
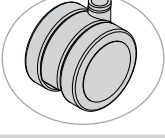
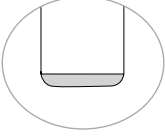
Casters or Glides	Code	Price	
Casters			
Black Carpet Casters	CS5	+ \$40	
Hard Floor and Carpet Casters	CS6	+ \$80	
Glides			
Standard Multi-Surface Glides	GL1	+ \$0	
Floor Saver Glides	GL3	+ \$17	
Steel Glides (Carpet Only)	GL4	+ \$17	
Performance Multi-Surface Glides	GL2	+ \$17	

Please use caution when stacking models with casters to prevent frame damage. SitOnIt Seating does not warrant scratched frames.

5. Miscellaneous

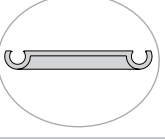
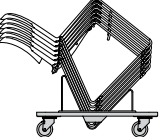
Accessories	Code	Price	
Ganging Brackets for Armless Models	GG	+ \$30	
Ganging Brackets for Models With Arms	GA	+ \$30	
Stacking Cart	CART	+ \$399	

Stacking carts require assembly.

Stacking cart (CART) is not compatible with caster models (CS5/CS6). See [page 630](#) for additional stacking requirements.

Due to the nature of upholstery, stacking may cause impressions on the seat. SitOnIt Seating does not warrant the effects of stacking on upholstery.

6. Material

Protection	Code	Price	
Fire Retardancy			
CAL 133, Fabric, Quantities 1-49	133F	+ \$64	
CAL 133, Fabric, Quantities 50+	133F5	+ \$20	
CAL 133, Leather, Any Quantity	133L	+ \$119	
CAL 133, Plastic, Any Quantity	133P	+ \$10	
Mesh Color	Code	Price	
Apple	MC31	+ \$0	
Aqua	MC30	+ \$0	
Desert	MC22	+ \$0	
Electric Blue	MC24	+ \$0	
Fire	MC25	+ \$0	
Fog	MC23	+ \$0	
Grape	MC26	+ \$0	
Lemon	MC27	+ \$0	
Nickel	MC21	+ \$0	
Ocean	MC29	+ \$0	
Onyx	MC20	+ \$0	
Tangerine	MC28	+ \$0	
Shell Color (For PS)	Code	Price	
Black	SC1	+ \$0	
Navy	SC5	+ \$0	
Slate	SC8	+ \$0	
Seat Textile Only (For US)	Code	Price	
Fabric/Vinyl Grade 1	FG1/VG1	+ \$0	
COM	COM	+ \$24	
Fabric/Vinyl Grade 2	FG2/VG2	+ \$24	
Fabric/Vinyl Grade 3	FG3/VG3	+ \$45	
Fabric/Vinyl Grade 4	FG4/VG4	+ \$77	
Fabric/Vinyl Grade 5	FG5/VG5	+ \$116	
Fabric/Vinyl Grade 6	FG6/VG6	+ \$159	
Fabric/Vinyl Grade 7	FG7/VG7	+ \$200	
Leather Grade 1	LG1	+ \$140	
COL	COL	+ \$200	
Leather Grade 2	LG2	+ \$200	
Leather Grade 3	LG3	+ \$280	

Please reference the [Textile Reference Guide](#) for pricing on fabric over grade 7 and leather over grade 3. Additional CAL 133 information can be found on [page 15](#).

MESH BACK MULTIPURPOSE CHAIR

7. Packaging

Packaging	Code	Price	
Fully Assembled In a Carton	AC3	+ \$0	
Individually Packaged	AC1	+ \$20	

SPECIFICATIONS

Model:	2221 FT1 MB Mesh Side Chair	2221 FT1 MB Mesh Side Chair With Casters
Dimensions		
Overall Width Armless	19.25"	21.75"
Overall Width With Arms	22.5"	22.5"
Overall Depth	23"	24.5"
Overall Height	33.75"	33.75"
Seat Width	18.5"	18.5"
Seat Depth	16.25"	16.25"
Seat Height	18.07" (PS) 18.53" (US)	18.07" (PS) 18.53" (US)
Back Width	19.25"	19.25"
Back Height	17"	17"
Materials		
COM	0.75 yd	0.75 yd
COL	10 sq ft	10 sq ft
Stacking		
Max Cart Stacking	4	Not Recommended
Max Floor Stacking	4	4
Weight and Capacity		
Cart Stacking Weight Armless	112 lb	Not Recommended
Cart Stacking Weight With Arms	128 lb	Not Recommended
Floor Stacking Weight Armless	62 lb	62 lb
Floor Stacking Weight With Arms	78 lb	78 lb
Weight Armless	14 lb (PS) 15.5 lb (US)	14 lb (PS) 15.5 lb (US)
Weight With Arms	18 lb (PS) 19.5 lb (US)	18 lb (PS) 19.5 lb (US)
Weight Capacity Warranty	300 lb	300 lb

Plastic seat (PS). Upholstered seat (US).

Wit Side

THINTEX BACK MULTIPURPOSE CHAIR

Work smarter.

A slimmer, stationary version of the task chair, our Wit Side is ideal for high-traffic settings like break rooms and cafeterias. Thanks to its ultra-lightweight frame and identical built-in pull handle, you can swing it around and rearrange spaces easily to accommodate the constant flow of crowded areas.



Better
Featured with Aqua thintex
and SitOnIt Seating's Dash — Cloud

EFFECTIVE NOVEMBER 4, 2024

Featured Models

GOOD :: \$423

Thintex back, plastic seat, armless, standard multi-surface glides

BETTER :: \$530

Thintex back, upholstered seat, fixed arms, standard multi-surface glides, grade 1 textile

BEST :: \$570

Thintex back, upholstered seat, fixed arms, carpet casters, grade 1 textile

Features

- Complements Wit task chair and Wit task stool
- Upholstered seat or plastic seat in three colors
- 12 Thintex back colors
- Built-in pull handle
- Black or silver frame
- Wall-saver frame design
- Textured arm pads
- Stacks four on the floor, four on the optional cart
- Choose from two caster types and four glide options
- 300 lb weight capacity warranty
- Complements by Wit task chair and stool; see [page 200](#) and [page 204](#)

1. Frame

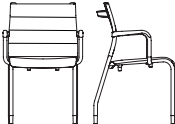
Frame Type	Code	Price	
4-Leg Side	2221 FT1 TXB	\$530	

Frame Finish	Code	Price	
Black	FC1	+ \$0	
Silver	FC2	+ \$0	

2. Back

Back Material	Code	Price	
Fabric	TX1	+ \$0	
Vinyl	TX2	+ \$0	

THINTEX BACK MULTIPURPOSE CHAIR

3. Seat

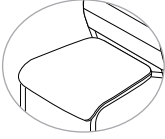
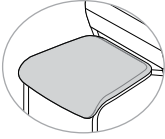
Seat Style	Code	Price	
Plastic Seat	PS	- \$58	
Upholstered Seat	US	+ \$0	

4. Arms

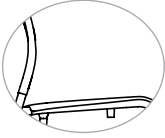
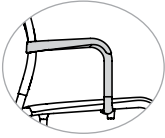
Arm Style	Code	Price	
Armless	AR0	- \$49	
Fixed Loop	AR1	+ \$0	

5. Base

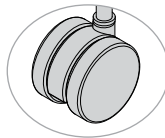
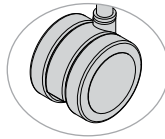
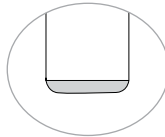
Casters or Glides	Code	Price	
Casters			
Black Carpet Casters	CS5	+ \$40	
Hard Floor and Carpet Casters	CS6	+ \$80	
Glides			
Standard Multi-Surface Glides	GL1	+ \$0	
Floor Saver Glides	GL3	+ \$17	
Steel Glides (Carpet Only)	GL4	+ \$17	
Performance Multi-Surface Glides	GL2	+ \$17	

Please use caution when stacking models with casters to prevent frame damage. SitOnIt Seating does not warrant scratched frames.

6. Miscellaneous

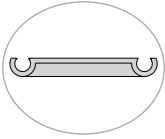
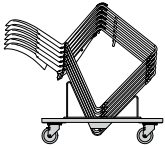
Accessories	Code	Price	
Ganging Brackets for Armless Models	GG	+ \$30	
Ganging Brackets for Models With Arms	GA	+ \$30	
Stacking Cart	CART	+ \$399	

Stacking carts require assembly.

Stacking cart (CART) is not compatible with caster models (CS5/CS6). See page 630 for additional stacking requirements.

Due to the nature of upholstery, stacking may cause impressions on the seat. SitOnIt Seating does not warrant the effects of stacking on upholstery.

7. Material

Protection	Code	Price	
Fire Retardancy			
CAL 133, Fabric, Quantities 1-49	133F	+ \$64	
CAL 133, Fabric, Quantities 50+	133F5	+ \$20	
CAL 133, Leather, Any Quantity	133L	+ \$119	
CAL 133, Plastic, Any Quantity	133P	+ \$10	
Thintex Color	Code	Price	
Apple	MC31	+ \$0	
Aqua	MC30	+ \$0	
Desert	MC22	+ \$0	
Electric Blue	MC24	+ \$0	
Fire	MC25	+ \$0	
Fog	MC23	+ \$0	
Grape	MC26	+ \$0	
Lemon	MC27	+ \$0	
Nickel	MC21	+ \$0	
Ocean	MC29	+ \$0	
Onyx	MC20	+ \$0	
Tangerine	MC28	+ \$0	
Shell Color (For PS)	Code	Price	
Black	SC1	+ \$0	
Navy	SC5	+ \$0	
Slate	SC8	+ \$0	

THINTEX BACK MULTIPURPOSE CHAIR

7. Material (Cont.)

Seat Textile (For US)	Code	Price	
Fabric/Vinyl Grade 1	FG1/VG1	+ \$0	
COM	COM	+ \$24	
Fabric/Vinyl Grade 2	FG2/VG2	+ \$24	
Fabric/Vinyl Grade 3	FG3/VG3	+ \$45	
Fabric/Vinyl Grade 4	FG4/VG4	+ \$77	
Fabric/Vinyl Grade 5	FG5/VG5	+ \$116	
Fabric/Vinyl Grade 6	FG6/VG6	+ \$159	
Fabric/Vinyl Grade 7	FG7/VG7	+ \$200	
Leather Grade 1	LG1	+ \$140	
COL	COL	+ \$200	
Leather Grade 2	LG2	+ \$200	
Leather Grade 3	LG3	+ \$280	

Please reference the [Textile Reference Guide](#) for pricing on fabric over grade 7 or leather over grade 3.



Good
Featured with a Black shell
and Lemon thintex

EFFECTIVE NOVEMBER 4, 2024 | GSA SIN #: 33721

8. Packaging

Packaging	Code	Price
Fully Assembled In a Carton	AC3	+ \$0
Fully Assembled In a Carton, Individually Packaged	AC1	+ \$20

SPECIFICATIONS

Model:	2221 FT1 TXB Thintex Side Chair	2221 FT1 TXB Thintex Side Chair With Casters
Dimensions		
Overall Width Armless	19.25"	21.75"
Overall Width With Arms	22.5"	22.5"
Overall Depth	23"	24.5"
Overall Height	33.75"	33.75"
Seat Width	18.5"	18.5"
Seat Depth	16.25"	16.25"
Seat Height	18.07" (PS) 18.53" (US)	18.07" (PS) 18.53" (US)
Back Width	19.25"	19.25"
Back Height	17"	17"
Materials		
COM	0.75 yd	0.75 yd
COL	10 sq ft	10 sq ft
Stacking		
Maximum Cart Stacking	4	Not Recommended
Maximum Floor Stacking	4	4
Weight and Capacity		
Cart Stacking Weight Armless	112 lb	Not Recommended
Cart Stacking Weight With Arms	128 lb	Not Recommended
Floor Stacking Weight Armless	62 lb	62 lb
Floor Stacking Weight With Arms	78 lb	78 lb
Weight Armless	14 lb (PS) 15.5 lb (US)	14 lb (PS) 15.5 lb (US)
Weight With Arms	18 lb (PS) 19.5 lb (US)	18 lb (PS) 19.5 lb (US)
Weight Capacity Warranty	300 lb	300 lb

Plastic seat (PS). Upholstered seat (US).



Best
Featured with Grape thintex and
SitOnIt Seating's Malibu — Violet

Lounge

CLUB CHAIR | SETTEE | SOFA
MODULAR LOUNGE
TANDEM SEATING | MULTISEATING
LINKING TABLES | COFFEE TABLES

Statement of Line

CLUB CHAIR | SETTEE | SOFA | MODULAR LOUNGE | MULTISEATING
TANDEM SEATING | BARIATRIC | LINKING TABLE | COFFEE TABLE

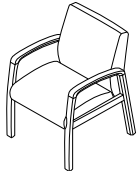

Aviera
Guest and Bariatric Seating
VRGPage 312

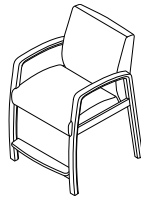

Aviera
Hip Chair
VRG FS3Page 317

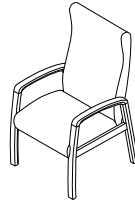

Aviera
Patient Seating
VRPPage 321

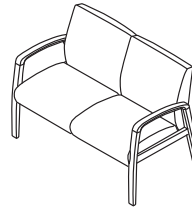

Aviera
Freespan 2-Seat
VRF SN2Page 326

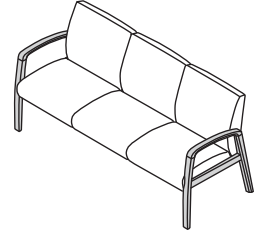

Aviera
Freespan 3-Seat
VRF SN3Page 326

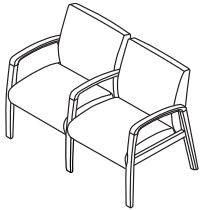

Aviera
Pre-Configured 2-Seat
VRC SN2Page 331

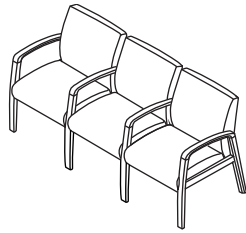

Aviera
Pre-Configured 3-Seat
VRC SN3Page 331

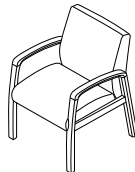

Aviera
Start Tandem Seating
VRM FS4Page 336



Aviera
Center/End Tandem Seating
VRM FS5/FS6Page 336

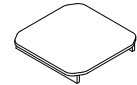

Aviera
Center Linking Table
VRL TTL1Page 341

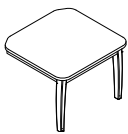

Aviera
End Linking Table
VRL TTL3Page 341

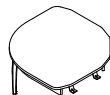

Aviera
Round Corner Linking Table
VRL TTL4Page 341

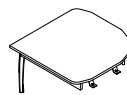

Aviera
Square Corner Linking Table
VRL TTL5Page 341

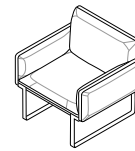

Cameo
Single Seat With Dual Arms
CAM SN1 FS8Page 345

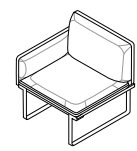

Cameo
Single Seat With Right Arm
CAM SN1 FS10Page 345

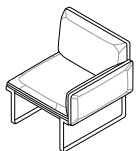

Cameo
Single Seat With Left Arm
CAM SN1 FS12Page 345

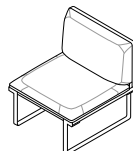

Cameo
Single Seat Armless
CAM SN1 FS17Page 345

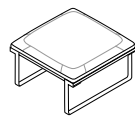

Cameo
Single Seat Bench
CAM SN1 FS2Page 345

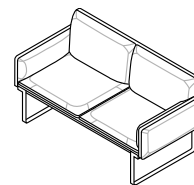

Cameo
2-Seater With Dual Arms
CAM SN2 FS8Page 345

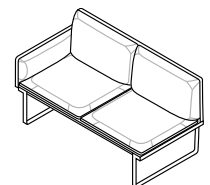

Cameo
2-Seater With Right Arm
CAM SN2 FS10Page 345

Statement of Line

CLUB CHAIR | SETTEE | SOFA | MODULAR LOUNGE
TANDEM SEATING | MULTISEATING | LINKING TABLE | COFFEE TABLE

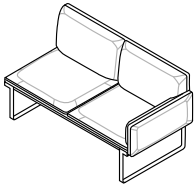

Cameo
2-Seater With Left Arm
CAM SN2 FS12Page 345

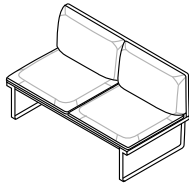

Cameo
2-Seater Armless
CAM SN2 FS17Page 345

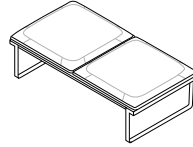

Cameo
2-Seater Bench
CAM SN2 FS2Page 345

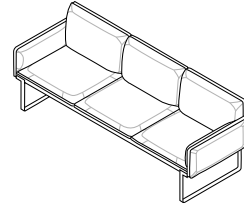

Cameo
3-Seater With Dual Arms
CAM SN3 FS8Page 345

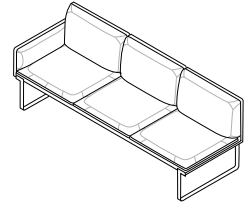

Cameo
3-Seater With Right Arm
CAM SN3 FS10Page 345

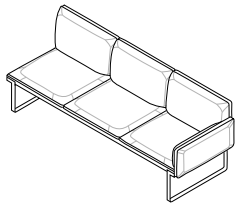

Cameo
3-Seater With Left Arm
CAM SN3 FS12Page 345

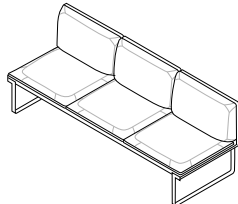

Cameo
3-Seater Armless
CAM SN3 FS17Page 345

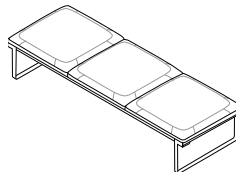

Cameo
3-Seater Bench
CAM SN3 FS2Page 345

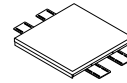

Cameo
Inline Table
CAMT TTL1Page 350

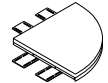

Cameo
Corner Table
CAMT TTL4Page 350

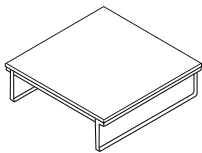

Cameo
Square Coffee Table
CAMT TT8Page 350

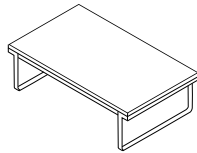

Cameo
Rectangular Coffee Table
CAMT TT9Page 350

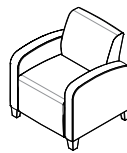

Composium
Curve Club Chair
CP AS3 SN1Page 352

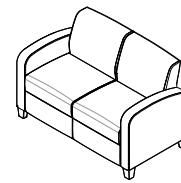

Composium
Curve Settee
CP AS3 SN2Page 352

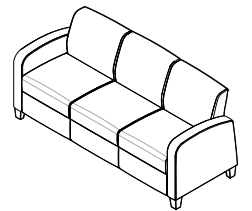

Composium
Curve Sofa
CP AS3 SN3Page 352

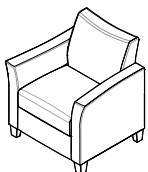

Composium
Flair Club Chair
CP AS2 SN1Page 357

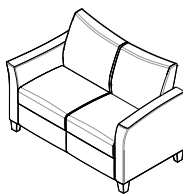

Composium
Flair Settee
CP AS2 SN2Page 357

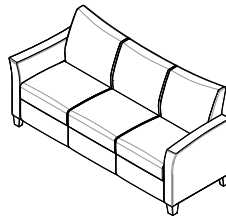

Composium
Flair Sofa
CP AS2 SN3Page 357

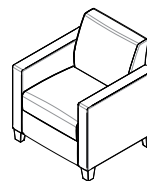

Composium
Sharp Club Chair
CP AS1 SN1Page 362

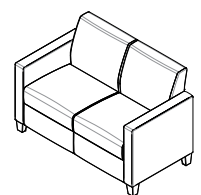

Composium
Sharp Settee
CP AS1 SN2Page 362

Statement of Line

CLUB CHAIR | SETTEE | SOFA | MODULAR LOUNGE | MULTISEATING
TANDEM SEATING | BARIATRIC | LINKING TABLE | COFFEE TABLE

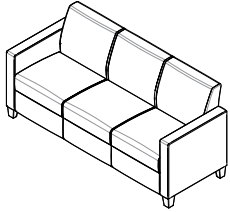

Composium

Sharp Sofa
CP AS1 SN3[Page 362](#)

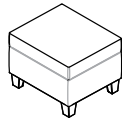

Composium

Ottoman
CP FS1[Page 367](#)

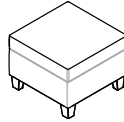

Composium

Single-Seat Bench
CP FS2 SN1[Page 367](#)

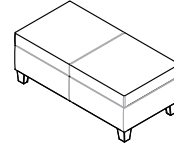

Composium

Double-Seat Bench
CP FS2 SN2[Page 367](#)

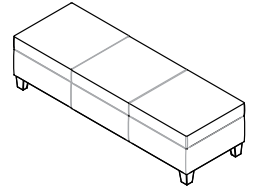

Composium

Three-Seat Bench
CP FS2 SN3[Page 367](#)



Envoi

Midback Lounge Chair
ENV BH4[Page 372](#)



Envoi

Highback Lounge Chair
ENV BH5[Page 372](#)



Gobi

Midback Lounge Chair
GBI BH4[Page 376](#)

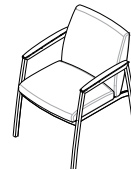

Kindl

21" Guest Chair
2080 NH SW21[Page 379](#)

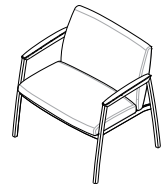

Kindl

30" Bariatric
2080 NH SW30[Page 379](#)

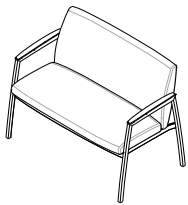

Kindl

42" Bariatric
2080 NH SW42[Page 379](#)

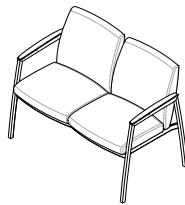

Kindl

Freespan
2082 SW42[Page 384](#)

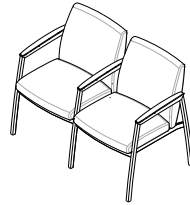

Kindl

Pre-Configured
2084 SW42[Page 384](#)

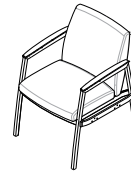

Kindl

21" Start
2083 FS4 SW21[Page 391](#)

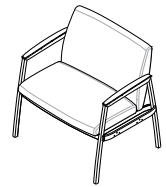

Kindl

30" Start
2083 FS4 SW30[Page 391](#)

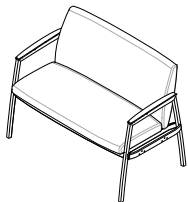

Kindl

42" Start
2083 FS4 SW42[Page 391](#)



Kindl

21" Center
2083 FS5 SW21[Page 391](#)

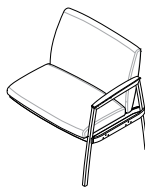

Kindl

30" Center
2083 FS5 SW30[Page 391](#)

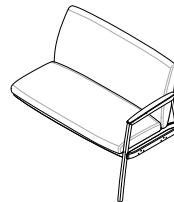

Kindl

42" Center
2083 FS5 SW42[Page 391](#)



Kindl

21" End
2083 FS5 SW21[Page 391](#)

Statement of Line

CLUB CHAIR | SETTEE | SOFA | MODULAR LOUNGE | MULTISEATING
TANDEM SEATING | BARIATRIC | LINKING TABLE | COFFEE TABLE



Kindl
30" End
2083 FS5 SW30[Page 391](#)

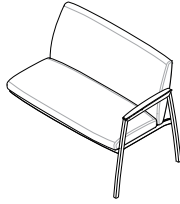

Kindl
42" End
2083 FS5 SW42[Page 391](#)



Nano
Triangle
NNO FS13[Page 402](#)

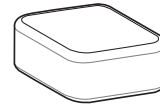

Nano
Diamond
NNO FS14[Page 402](#)

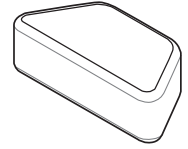

Nano
Trapezoid
NNO FS15[Page 402](#)

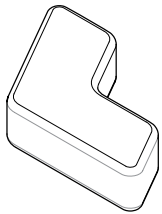

Nano
Boomerang
NNO FS16[Page 402](#)



Nano
Triangle Table
NNO FS13 TM3/TM4[Page 402](#)



Nano
Triangle Table
NNO FS13 TM3/TM4[Page 402](#)

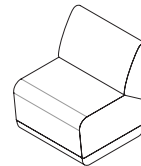

Paséa
Single Seat
PAS FS17 SS1[Page 411](#)

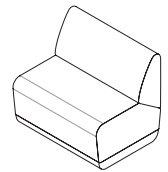

Paséa
1.5 Seat
PAS FS17 SS2[Page 411](#)

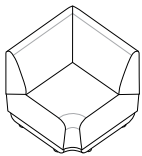

Paséa
90-Degree Corner Seat
PAS FS17 SS5[Page 411](#)

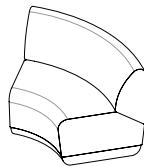

Paséa
120-Degree Inner Seat
PAS FS17 SS3[Page 411](#)

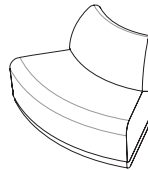

Paséa
120-Degree Outer Seat
PAS FS17 SS4[Page 411](#)

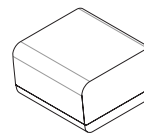

Paséa
Single Bench
PAS FS2 BNS1[Page 411](#)

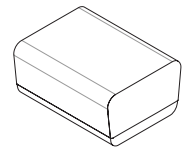

Paséa
1.5 Bench
PAS FS2 BNS2[Page 411](#)

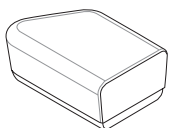

Paséa
Right-Angled End Bench
PAS FS2 BNS3[Page 411](#)

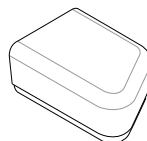

Paséa
Left-Angled End Bench
PAS FS2 BNS4[Page 411](#)

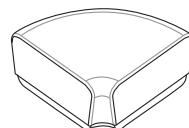

Paséa
90-Degree Corner Bench
PAS FS2 BNS5[Page 411](#)

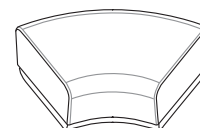

Paséa
120-Degree Bench
PAS FS2 BNS6[Page 411](#)

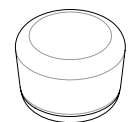

Paséa
Mini Round Ottoman
PAS FS1 OS1[Page 411](#)

Statement of Line

CLUB CHAIR | SETTEE | SOFA | MODULAR LOUNGE | MULTISEATING
TANDEM SEATING | BARIATRIC | LINKING TABLE | COFFEE TABLE

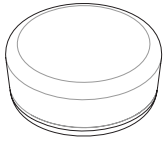

Paséa
Large Round Ottoman
PAS FS1 OS2Page 419

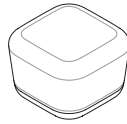

Paséa
Mini Square Ottoman
PAS FS1 OS3Page 419

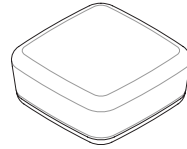

Paséa
Large Square Ottoman
PAS FS1 OS4Page 419

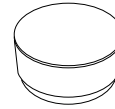

Paséa
Mini Round Table
PAS FS1 OS1 TM3Page 419

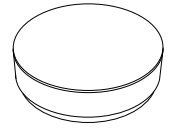

Paséa
Large Round Table
PAS FS1 OS2 TM3Page 419



Paséa
Mini Square Table
PAS FS1 OS3 TM3Page 419

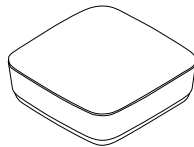

Paséa
Large Square Table
PAS FS1 OS4 TM3Page 419

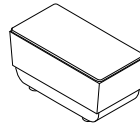

Paséa
13" x 27" Table
FS18 BNS7Page 423

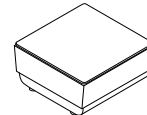

Paséa
27" x 27" Table
FS18 BNS1Page 423

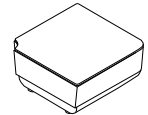

Paséa
90-Degree Corner Table
FS18 BNS5Page 423

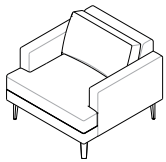

Sable
Club Chair With Arms
FS30 CN1Page 426

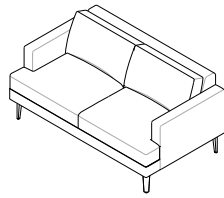

Sable
Settee With Arms
FS45 CN2Page 426

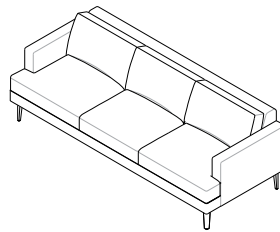

Sable
Sofa With Arms
FS49 CN3Page 426

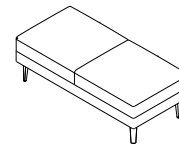

Sable
2-Seat Bench
FS59 CN2Page 426

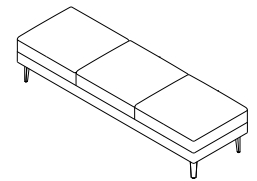

Sable
3-Seat Bench
FS60 CN3Page 426

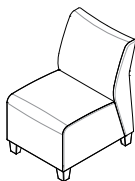

Visit Modular
Armless Club Chair
VSPage 431

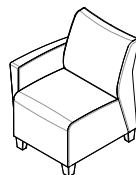

Visit Modular
Club Chair With Right Arm
VS FS10Page 431

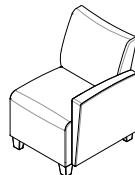

Visit Modular
Club Chair With Left Arm
VS FS12Page 431

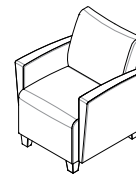

Visit Modular
Club Chair With Both Arms
VS FS8Page 431

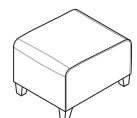

Visit Modular
Ottoman
VS FS1Page 431

Aviera

GUEST AND BARIATRIC SEATING

Comfort that lasts.

Whether lobby, lounge, welcoming or waiting, you can rest easy with supremely comfortable do-it-all seating for your public spaces. Aviera makes it easy to configure endlessly and effortlessly—across an entire collection—with worry-free design and lasting durability, including metal or wood frames that feature an integrated steel structure. Discover an industry-leading seating solution and get peace of mind for any project.



Metal
Featured with SitOnIt's Element — Chalk
and DesignTex's Leap — Tide Pool

EFFECTIVE NOVEMBER 4, 2024

Featured Models

METAL :: \$1,434

Metal frame, 21" seat, open arms, polyurethane arm caps, multi-upholstery, grade 2 vinyl seat, grade 5 vinyl back

WOOD :: \$1,778

Maple frame, 21" seat, open arms, no arm caps, multi-upholstery, grade 4 vinyl seat, grade 7 vinyl back

BARIATRIC :: \$2,150

Metal frame, 30" seat, open arms, polyurethane arm caps, multi-upholstery, grade 4 vinyl seat, grade 7 fabric back

Features

- Easy ingress and egress with 18.5" seat height and waterfall seat design
- Clean-out space
- Steel-frame construction with metal-to-metal connections
- Beveled, wall-saving frame design
- Two frame materials: Durable aluminum frame or wood frame with silver ion anti-microbial finish
- Three metal frame finishes or four wood frame finishes
- Polyurethane, wood or solid surface arm caps
- Replaceable parts including seat, back, arms, arm caps and arm insets
- 21"/24" seats: 500 lb weight capacity warranty
30"/44" bariatric seats: 750 lb weight capacity warranty



Metal
Featured with SitOnIt's Element – Chalk
and Momentum's – Silica Fiona – Bay

1. Product

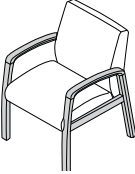

Model	Code	Price	
Guest	VRG	\$1,054	

2. Frame

Frame Material	Code	Price	
Metal	FM3	+ \$0	
Wood			
Beech	FM2	+ \$10	
Maple	FM1	+ \$68	
Frame Finish	Code	Price	
For Metal Frame			
Silver Metallic	FCM1	+ \$0	
Graphite	FCM2	+ \$0	
Taupe	FCM3	+ \$0	
For Wood Frame			
Clear Maple	FCW1	+ \$0	
Medium Cherry	FCW2	+ \$0	
Amber Mahogany	FCW3	+ \$0	
Espresso	FCW4	+ \$0	
Stain-to-Match	STM	+ \$70	
Frame Options	Code	Price	
Protective Guard Clear Tape	FX1	+ \$84	

Stain-to-Match (STM) requires a one-time set up fee of \$275.

3. Seat

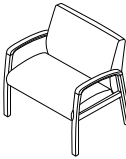
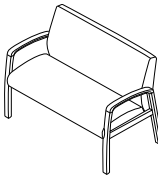
Seat Width	Code	Price	
21" (500 lb Weight Capacity)	SW21	+ \$0	
24" (500 lb Weight Capacity)	SW24	+ \$65	
Bariatric			
30" (750 lb Weight Capacity)	SW30	+ \$315	
44" (750 lb Weight Capacity)	SW44	+ \$510	

See the Super Duty Guide on [page 626](#) for additional high weight capacity products.

4. Arms

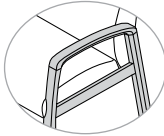
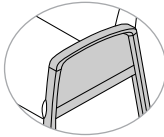
Arm Type	Code	Price	
Open Arm	AT1	+ \$0	
Upholstered Arm	AT2	+ \$86	

GUEST AND BARIATRIC SEATING

4. Arms (Cont.)

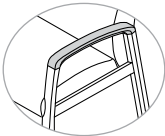
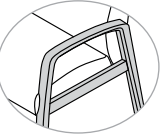
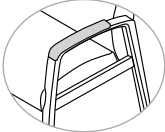
Arm Cap Material	Code	Price	
For Metal Frame			
Polyurethane	ACP4	+ \$0	
Wood	ACP3	+ \$120	
Solid Surface	ACP5	+ \$500	
For Wood Frame			
No Arm Caps	ACP0	+ \$0	
Polyurethane	ACP2	+ \$120	

Arm Cap Finish	Code	Price	
For Polyurethane Arm Caps			
Black	RMC3	+ \$0	
Fog	RMC4	+ \$0	
Dark Grey	RMC5	+ \$0	
For Wood Arm Caps			
Clear Maple	FCW1	+ \$0	
Medium Cherry	FCW2	+ \$0	
Amber Mahogany	FCW3	+ \$0	
Espresso	FCW4	+ \$0	
Stain-to-Match	STM	+ \$70	
For Solid Surface Arm Caps			
Designer White	TSS2	+ \$0	

Stain-to-Match (STM) requires a one-time set up fee of \$275.
Upholstered arm textile will match seat textile.

5. Material

Protection	Code	Price	
Fire Retardancy			
CAL 133	UCAL	+ \$100	
Cleaning	Code	Price	
Moisture Barrier			
Seat Only	UM2	+ \$65	
Back Only	UM1	+ \$65	
Seat and Back	UM3	+ \$130	
Fully Upholstered	Code	Price	
Seat and Back Textile		21"/24"	30"/44"
Fabric/Vinyl Grade 1	FG1/VG1	+ \$0	+ \$0
COM	COM	+ \$60	+ \$100
Fabric/Vinyl Grade 2	FG2/VG2	+ \$60	+ \$100
Fabric/Vinyl Grade 3	FG3/VG3	+ \$150	+ \$220
Fabric/Vinyl Grade 4	FG4/VG4	+ \$275	+ \$365
Fabric/Vinyl Grade 5	FG5/VG5	+ \$415	+ \$525
Fabric/Vinyl Grade 6	FG6/VG6	+ \$575	+ \$705
Fabric/Vinyl Grade 7	FG7/VG7	+ \$735	+ \$885
Leather Grade 1	LG1	+ \$600	+ \$685
COL	COL	+ \$700	+ \$805
Leather Grade 2	LG2	+ \$700	+ \$805
Leather Grade 3	LG3	+ \$800	+ \$1,005
Multi-Upholstery	Code	Price	
		21"/24"	30"/44"
Multi-Upholstery Upcharge	UMU	+ \$113	+ \$113
Seat Textile Only		21"/24"	30"/44"
Fabric/Vinyl Grade 1	FG1/VG1	+ \$0	+ \$0
COM	COM	+ \$26	+ \$42
Fabric/Vinyl Grade 2	FG2/VG2	+ \$26	+ \$42
Fabric/Vinyl Grade 3	FG3/VG3	+ \$63	+ \$93
Fabric/Vinyl Grade 4	FG4/VG4	+ \$116	+ \$154
Fabric/Vinyl Grade 5	FG5/VG5	+ \$175	+ \$221
Fabric/Vinyl Grade 6	FG6/VG6	+ \$242	+ \$297
Fabric/Vinyl Grade 7	FG7/VG7	+ \$309	+ \$372
Leather Grade 1	LG1	+ \$252	+ \$288
COL	COL	+ \$294	+ \$339
Leather Grade 2	LG2	+ \$294	+ \$339
Leather Grade 3	LG3	+ \$336	+ \$423

5. Material (Cont.)

Multi-Upholstery	Code	Price	
Back Textile Only		21"/24"	30"/44"
Fabric/Vinyl Grade 1	FG1/VG1	+ \$0	+ \$0
COM	COM	+ \$35	+ \$58
Fabric/Vinyl Grade 2	FG2/VG2	+ \$35	+ \$58
Fabric/Vinyl Grade 3	FG3/VG3	+ \$87	+ \$128
Fabric/Vinyl Grade 4	FG4/VG4	+ \$160	+ \$212
Fabric/Vinyl Grade 5	FG5/VG5	+ \$241	+ \$305
Fabric/Vinyl Grade 6	FG6/VG6	+ \$334	+ \$409
Fabric/Vinyl Grade 7	FG7/VG7	+ \$427	+ \$514
Leather Grade 1	LG1	+ \$348	+ \$398
COL	COL	+ \$406	+ \$467
Leather Grade 2	LG2	+ \$406	+ \$467
Leather Grade 3	LG3	+ \$464	+ \$583

If different fabrics are selected for the seat and back, add the multi-upholstery upcharge as well, even if the fabrics are the same grade.

Please reference the [Textile Reference Guide](#) for pricing on fabric over grade 7 and leather over grade 3. Additional CAL 133 information can be found on [page 15](#).

6. Options

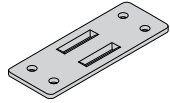
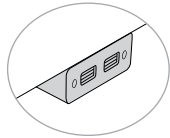
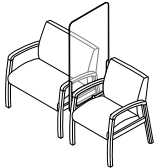
Ganging Brackets	Code	Price	
Ganging Brackets	XGV	+ \$103	
Power Options	Code	Price	
Power, Left	PFL	+ \$250	
Power, Right	PFR	+ \$250	
Screen	Code	Price	
Sector Seating Screen	3097 XRX	+ \$460	
Packaging	Code	Price	
Fully Assembled in a Carton	P1	+ \$0	

SPECIFICATIONS

Model:	21"	24"
Dimensions		
Height	34.5"	34.5"
Width	24.5"	27.5"
Depth	26.5"	26.5"
Arm Height (Height of Arms From Floor)	25.75"	25.75"
Arm Height (From Seat to Top of Arm)	7.25"	7.25"
Width Between Arms	20.75"	23.75"
Seat Width	21.75"	24.75"
Seat Depth	19"	19"
Seat Height	18.5"	18.5"
Back Height	18.5"	18.5"
Materials		
COM (Fully Upholstered)	1.9 yd	1.9 yd
COM (Multi-Upholstery)		
Seat Only	1.2 yd	1.2 yd
Back Only	1.1 yd	1.6 yd
COL (Fully Upholstered)	29.4 sq ft	43.4 sq ft
Weight and Capacity		
Weight	38 lb (FM3) 33 lb (FM1/FM2)	40 lb (FM3) 35 lb (FM1/FM2)
Weight Capacity Warranty	500 lb	500 lb

Metal frame (FM3), Beech wood frame (FM2), Maple wood frame (FM1).

Yardage requirements for COM and COL are for solid and non-directional fabrics. Additional material may be required for larger repeating patterns.

SPECIFICATIONS: BARIATRIC SIZES

Model:	30"	44"
Dimensions		
Height	34.5"	34.5"
Width	33.5"	47.5"
Depth	26.5"	26.5"
Arm Height (Height of Arms From Floor)	25.75"	25.75"
Arm Height (From Seat to Top of Arm)	7.25"	7.25"
Width Between Arms	29.75"	43.75"
Seat Width	30.75"	44.75"
Seat Depth	19"	19"
Seat Height	18.5"	18.5"
Back Height	18.5"	18.5"
Materials		
COM (Fully Upholstered)	3.1 yd	3.4 yd
COM (Multi-Upholstery)		
Seat Only	1.2 yd	1.6 yd
Back Only	1.9 yd	1.9 yd
COL (Fully Upholstered)	47.6 sq ft	50.4 sq ft
Weight and Capacity		
Weight	50 lb (FM3) 45 lb (FM1/FM2)	77 lb (FM3) 72 lb (FM1/FM2)
Weight Capacity Warranty	750 lb	750 lb

Metal frame (FM3), Beech wood frame (FM2), Maple wood frame (FM1).

Yardage requirements for COM and COL are for solid and non-directional fabrics. Additional material may be required for larger repeating patterns.



Aviera

HIP CHAIR

Comfort that lasts.

Whether lobby, lounge, welcoming or waiting, you can rest easy with supremely comfortable do-it-all seating for your public spaces. Aviera makes it easy to configure endlessly and effortlessly—across an entire collection—with worry-free design and lasting durability, including metal or wood frames that feature an integrated steel structure. Discover an industry-leading seating solution and get peace of mind for any project.



Metal

EFFECTIVE NOVEMBER 4, 2024

Featured Models

METAL :: \$2,271

Metal frame, open arms, polyurethane arm caps, fully upholstered, grade 7 vinyl seat and back

WOOD :: \$2,186

Maple frame, open arms, no arm caps, multi-upholstery, grade 4 vinyl seat, grade 5 vinyl back

Features

- Easy ingress and egress with waterfall seat design
- Clean-out space
- Steel-frame construction with metal-to-metal connections
- Beveled, wall-saving frame design
- Elevated footrest with a non-slip textured surface
- Two frame materials: Durable aluminum frame or wood frame with silver ion anti-microbial finish
- Three metal frame finishes or four wood frame finishes
- Polyurethane, wood or solid surface arm caps
- Replaceable parts including seat, back, arms, arm caps and arm insets
- 500 lb weight capacity warranty



HIP CHAIR

1. Product

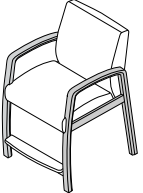
Model	Code	Price	
Hip Chair (500 lb Weight Capacity)	VRG FS3	\$1,536	

2. Frame

Frame Material	Code	Price	
Metal	FM3	+ \$0	
Wood			
Beech	FM2	+ \$93	
Maple	FM1	+ \$180	
Frame Finish	Code	Price	
For Metal Frame			
Silver Metallic	FCM1	+ \$0	
Graphite	FCM2	+ \$0	
Taupe	FCM3	+ \$0	
For Wood Frame			
Clear Maple	FCW1	+ \$0	
Medium Cherry	FCW2	+ \$0	
Amber Mahogany	FCW3	+ \$0	
Espresso	FCW4	+ \$0	
Stain-to-Match	STM	+ \$70	
Frame Options	Code	Price	
Protective Guard Clear Tape	FX1	+ \$84	

Stain-to-Match (STM) requires a one-time set up fee of \$275.

3. Arms

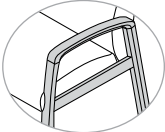
Arm Type	Code	Price	
Open Arm	AT1	+ \$0	

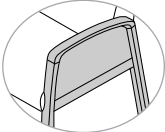
Upholstered Arm	AT2	+ \$86	
-----------------	-----	--------	---

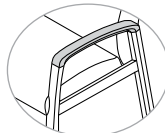
Arm Cap Material	Code	Price	
For Metal Frame			
Polyurethane	ACP4	+ \$0	
Wood	ACP3	+ \$120	
Solid Surface	ACP5	+ \$500	

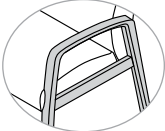
For Wood Frame			
No Arm Cap	ACP0	+ \$0	

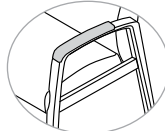
Polyurethane	ACP2	+ \$120	
--------------	------	---------	---

Arm Cap Finish	Code	Price	
For Polyurethane Arm Caps			
Black	RMC3	+ \$0	
Fog	RMC4	+ \$0	
Dark Grey	RMC5	+ \$0	
For Wood Arm Caps			
Clear Maple	FCW1	+ \$0	
Medium Cherry	FCW2	+ \$0	
Amber Mahogany	FCW3	+ \$0	
Espresso	FCW4	+ \$0	
Stain-to-Match	STM	+ \$70	
For Solid Surface Arm Caps			
Designer White	TSS2	+ \$0	

Stain-to-Match (STM) requires a one-time set up fee of \$275.

Upholstered arm textile will match seat textile.

HIP CHAIR

4. Material

Protection	Code	Price	
Fire Retardancy			
CAL 133	UCAL	+ \$100	
Cleaning			
Moisture Barrier			
Seat Only	UM2	+ \$65	
Back Only	UM1	+ \$65	
Seat and Back	UM3	+ \$130	
Fully Upholstered			
Fabric/Vinyl Grade 1	FG1/VG1	+ \$0	
COM	COM	+ \$60	
Fabric/Vinyl Grade 2	FG2/VG2	+ \$60	
Fabric/Vinyl Grade 3	FG3/VG3	+ \$150	
Fabric/Vinyl Grade 4	FG4/VG4	+ \$275	
Fabric/Vinyl Grade 5	FG5/VG5	+ \$415	
Fabric/Vinyl Grade 6	FG6/VG6	+ \$575	
Fabric/Vinyl Grade 7	FG7/VG7	+ \$735	
Leather Grade 1	LG1	+ \$600	
COL	COL	+ \$700	
Leather Grade 2	LG2	+ \$700	
Leather Grade 3	LG3	+ \$800	
Multi-Upholstery			
Multi-Upholstery Upcharge	UMU	+ \$113	
Seat Textile Only			
Fabric/Vinyl Grade 1	FG1/VG1	+ \$0	
COM	COM	+ \$26	
Fabric/Vinyl Grade 2	FG2/VG2	+ \$26	
Fabric/Vinyl Grade 3	FG3/VG3	+ \$63	
Fabric/Vinyl Grade 4	FG4/VG4	+ \$116	
Fabric/Vinyl Grade 5	FG5/VG5	+ \$175	
Fabric/Vinyl Grade 6	FG6/VG6	+ \$242	
Fabric/Vinyl Grade 7	FG7/VG7	+ \$309	
Leather Grade 1	LG1	+ \$252	
COL	COL	+ \$294	
Leather Grade 2	LG2	+ \$294	
Leather Grade 3	LG3	+ \$336	

4. Material (Cont.)

Multi-Upholstery	Code	Price
Back Textile Only		
Fabric/Vinyl Grade 1	FG1/VG1	+ \$0
COM	COM	+ \$35
Fabric/Vinyl Grade 2	FG2/VG2	+ \$35
Fabric/Vinyl Grade 3	FG3/VG3	+ \$87
Fabric/Vinyl Grade 4	FG4/VG4	+ \$160
Fabric/Vinyl Grade 5	FG5/VG5	+ \$241
Fabric/Vinyl Grade 6	FG6/VG6	+ \$334
Fabric/Vinyl Grade 7	FG7/VG7	+ \$427
Leather Grade 1	LG1	+ \$348
COL	COL	+ \$406
Leather Grade 2	LG2	+ \$406
Leather Grade 3	LG3	+ \$464

If different fabrics are selected for the seat and back, add the multi-upholstery upcharge as well, even if the fabrics are the same grade.

Please reference the [Textile Reference Guide](#) for pricing on fabric over grade 7 and leather over grade 3. Additional CAL 133 information can be found on [page 15](#).

5. Packaging

Packaging	Code	Price
Fully Assembled in a Carton	P1	+ \$0

HIP CHAIR

SPECIFICATIONS

Model:	VRG FS3 21" Hip Chair
Dimensions	
Height	40.25"
Width	24.5"
Depth	28.25"
Arm Height (Height of Arms From Floor)	31.75"
Arm Height (From Seat to Top of Arm)	7.25"
Width Between Arms	20.75"
Seat Width	21.75"
Seat Depth	19"
Seat Height	24.5"
Back Height	18.5"
Footrest Height (From Floor)	7"
Materials	
COM (Fully Upholstered)	1.9 yd
COM (Multi-Upholstery)	
Seat Only	1.2 yd
Back Only	1.1 yd
COL (Fully Upholstered)	29.4 sq ft
Weight and Capacity	
Weight	38 lb (FM3) 33 lb (FM1/FM2)
Weight Capacity Warranty	500 lb

Metal frame (FM3), Beech wood frame (FM2), Maple wood frame (FM1).

Yardage requirements for COM and COL are for solid and non-directional fabrics. Additional material may be required for larger repeating patterns.

Aviera

PATIENT SEATING

Comfort that lasts.

Whether lobby, lounge, welcoming or waiting, you can rest easy with supremely comfortable do-it-all seating for your public spaces. Aviera makes it easy to configure endlessly and effortlessly—across an entire collection—with worry-free design and lasting durability, including metal or wood frames that feature an integrated steel structure. Discover an industry-leading seating solution and get peace-of-mind for any project.



EFFECTIVE NOVEMBER 4, 2024

Featured Models

METAL :: \$1,729

Metal frame, 21" seat, open arms, polyurethane arm caps, multi-upholstery, grade 4 vinyl seat and grade 5 vinyl back

WOOD :: \$1,983

Maple frame, 21" seat, open arms, no arm caps, multi-upholstery, grade 4 vinyl seat and grade 7 vinyl back

BARIATRIC :: \$2,243

Metal frame, 30" seat, open arms, polyurethane arm caps, multi-upholstery, grade 2 vinyl seat and grade 7 fabric back

Features

- Easy ingress and egress with waterfall seat design
- Clean-out space
- Steel-frame construction with metal-to-metal connections
- Beveled, wall-saving frame design
- Two frame materials: Durable aluminum frame or wood frame with silver ion anti-microbial finish
- Three metal frame finishes or four wood frame finishes
- Polyurethane, wood or solid surface arm caps
- Replaceable parts including seat, back, arms, arm caps and arm insets
- 21"/24" seat: 500 lb weight capacity warranty
30" bariatric seat: 750 lb weight capacity warranty



Wood

PATIENT SEATING

1. Product

Model	Code	Price	
Aviera Patient	VRP	\$1,259	

2. Frame

Frame Material	Code	Price	
Metal	FM3	+ \$0	
Wood			
Beech	FM2	+ \$10	
Maple	FM1	+ \$68	
Frame Finish	Code	Price	
For Metal Frame			
Silver Metallic	FCM1	+ \$0	
Graphite	FCM2	+ \$0	
Taupe	FCM3	+ \$0	
For Wood Frame			
Clear Maple	FCW1	+ \$0	
Medium Cherry	FCW2	+ \$0	
Amber Mahogany	FCW3	+ \$0	
Espresso	FCW4	+ \$0	
Stain-to-Match	STM	+ \$70	
Frame Options	Code	Price	
Protective Guard Clear Tape	FX1	+ \$84	

Stain-to-Match (STM) requires a one-time set up fee of \$275.

3. Seat

Seat Width	Code	Price	
21" (500 lb Weight Capacity)	SW21	+ \$0	
24" (500 lb Weight Capacity)	SW24	+ \$65	
Bariatric			
30" (750 lb Weight Capacity)	SW30	+ \$315	

See the Super Duty Guide on [page 626](#) for additional high weight capacity products.

4. Arms

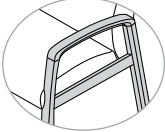
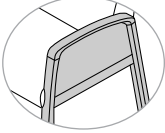
Arm Type	Code	Price	
Open Arm	AT1	+ \$0	
Upholstered Arm	AT2	+ \$86	

Upholstered arm textile will match seat textile.

PATIENT SEATING

4. Arms (Cont.)

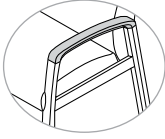
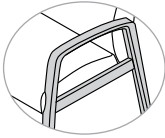
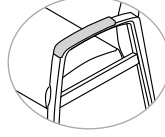
Arm Cap Material	Code	Price	
For Metal Frame			
Polyurethane	ACP4	+ \$0	
Wood	ACP3	+ \$120	
Solid Surface	ACP5	+ \$500	
Arm Cap Material	Code	Price	
For Wood Frame			
No Arm Cap	ACP0	+ \$0	
Polyurethane	ACP2	+ \$120	
Arm Cap Finish	Code	Price	
For Polyurethane Arm Caps			
Black	RMC3	+ \$0	
Fog	RMC4	+ \$0	
Dark Grey	RMC5	+ \$0	
For Wood Arm Caps			
Clear Maple	FCW1	+ \$0	
Medium Cherry	FCW2	+ \$0	
Amber Mahogany	FCW3	+ \$0	
Espresso	FCW4	+ \$0	
Stain-to-Match	STM	+ \$70	
For Solid Surface Arm Caps			
Designer White	TSS2	+ \$0	

Stain-to-Match (STM) requires a one-time set up fee of \$275.

Upholstered arm textile will match seat textile.

5. Material

Protection	Code	Price	
Fire Retardancy			
CAL 133	UCAL	+ \$100	
Cleaning	Code	Price	
Moisture Barrier			
Seat Only	UM2	+ \$65	
Back Only	UM1	+ \$65	
Seat and Back	UM3	+ \$130	
Fully Upholstered	Code	Price	
Seat and Back Textile		21"/24"	30"
Fabric/Vinyl Grade 1	FG1/VG1	+ \$0	+ \$0
COM	COM	+ \$60	+ \$100
Fabric/Vinyl Grade 2	FG2/VG2	+ \$60	+ \$100
Fabric/Vinyl Grade 3	FG3/VG3	+ \$150	+ \$220
Fabric/Vinyl Grade 4	FG4/VG4	+ \$275	+ \$365
Fabric/Vinyl Grade 5	FG5/VG5	+ \$415	+ \$525
Fabric/Vinyl Grade 6	FG6/VG6	+ \$575	+ \$705
Fabric/Vinyl Grade 7	FG7/VG7	+ \$735	+ \$885
Leather Grade 1	LG1	+ \$600	+ \$685
COL	COL	+ \$700	+ \$805
Leather Grade 2	LG2	+ \$700	+ \$805
Leather Grade 3	LG3	+ \$800	+ \$1,005
Multi-Upholstery	Code	Price	
		21"/24"	30"
Multi-Upholstery Upcharge	UMU	+ \$113	+ \$113
Seat Textile Only		21"/24"	30"
Fabric/Vinyl Grade 1	FG1/VG1	+ \$0	+ \$0
COM	COM	+ \$26	+ \$42
Fabric/Vinyl Grade 2	FG2/VG2	+ \$26	+ \$42
Fabric/Vinyl Grade 3	FG3/VG3	+ \$63	+ \$93
Fabric/Vinyl Grade 4	FG4/VG4	+ \$116	+ \$154
Fabric/Vinyl Grade 5	FG5/VG5	+ \$175	+ \$221
Fabric/Vinyl Grade 6	FG6/VG6	+ \$242	+ \$297
Fabric/Vinyl Grade 7	FG7/VG7	+ \$309	+ \$372
Leather Grade 1	LG1	+ \$252	+ \$288
COL	COL	+ \$294	+ \$339
Leather Grade 2	LG2	+ \$294	+ \$339
Leather Grade 3	LG3	+ \$336	+ \$423
Back Textile Only		21"/24"	30"
Fabric/Vinyl Grade 1	FG1/VG1	+ \$0	+ \$0
COM	COM	+ \$35	+ \$58

5. Material (Cont.)

Multi-Upholstery	Code	Price	
Fabric/Vinyl Grade 2	FG2/VG2	+ \$35	+ \$58
Fabric/Vinyl Grade 3	FG3/VG3	+ \$87	+ \$128
Fabric/Vinyl Grade 4	FG4/VG4	+ \$160	+ \$212
Fabric/Vinyl Grade 5	FG5/VG5	+ \$241	+ \$305
Fabric/Vinyl Grade 6	FG6/VG6	+ \$334	+ \$409
Fabric/Vinyl Grade 7	FG7/VG7	+ \$427	+ \$514
Leather Grade 1	LG1	+ \$348	+ \$398
COL	COL	+ \$406	+ \$467
Leather Grade 2	LG2	+ \$406	+ \$467
Leather Grade 3	LG3	+ \$464	+ \$583

If different fabrics are selected for the seat and back, add the multi-upholstery upcharge as well, even if the fabrics are the same grade.

Please reference the [Textile Reference Guide](#) for pricing on fabric over grade 7 and leather over grade 3. Additional CAL 133 information can be found on [page 15](#).

6. Options

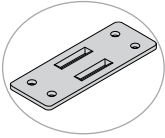
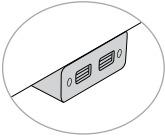
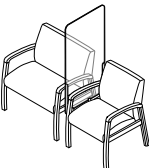
Ganging Brackets	Code	Price	
Ganging Brackets	XGV	+ \$103	
Power Options	Code	Price	
Power, Left	PFL	+ \$250	
Power, Right	PFR	+ \$250	
Screen	Code	Price	
Sector Seating Screen	3097 XRX	+ \$460	

7. Packaging

Packaging	Code	Price
Fully Assembled in a Carton	P1	+ \$0

EFFECTIVE NOVEMBER 4, 2024 | GSA SIN #: 33721

SPECIFICATIONS

Model:	VRP SW21 21" Seat	VRP SW24 24" Seat	VRP SW30 30" Seat
Dimensions			
Height	44"	44"	44"
Width	24.5"	27.5"	33.5"
Depth	26.5"	26.5"	26.5"
Arm Height (Height of Arms From Floor)	25.75"	25.75"	25.75"
Arm Height (From Seat to Top of Arm)	7.25"	7.25"	7.25"
Width Between Arms	20.75"	23.75"	29.75"
Seat Width	21.75"	24.75"	30.75"
Seat Depth	19"	19"	19"
Seat Height	18.5"	18.5"	18.5"
Back Height	28.5"	28.5"	28.5"
Materials			
COM (Fully Upholstered)	2.8 yd	2.8 yd	3.8 yd
COM (Multi-Upholstery)			
Seat Only	1.2 yd	1.2 yd	1.2 yd
Back Only	1.9 yd	2.2 yd	2.5 yd
COL (Fully Upholstered)	35 sq ft	43.4 sq ft	50 sq ft
Weight and Capacity			
Weight	42 lb (FM3)	44 lb (FM3)	57 lb (FM3)
	37 lb (FM1/FM2)	39 lb (FM1/FM2)	52 lb (FM1/FM2)
Weight Capacity Warranty	500 lb	500 lb	750 lb

Metal frame (FM3), Beech wood frame (FM2), Maple wood frame (FM1).

Yardage requirements for COM and COL are for solid and non-directional fabrics. Additional material may be required for larger repeating patterns.



Bariatric

Aviera

FREESPAN MULTISEATING

Comfort that lasts.

Whether lobby, lounge, welcoming or waiting, you can rest easy with supremely comfortable do-it-all seating for your public spaces. Aviera makes it easy to configure endlessly and effortlessly—across an entire collection—with worry-free design and lasting durability, including metal or wood frames that feature an integrated steel structure. Discover an industry-leading seating solution and get peace of mind for any project.



Metal 2-Seat

EFFECTIVE NOVEMBER 4, 2024

Featured Models

METAL 2-SEAT :: \$2,551

Metal frame, 21" seat, open arms, polyurethane arm caps, multi-upholstery, grade 3 vinyl seat and grade 5 vinyl back

WOOD 2-SEAT :: \$2,915

Maple frame, 21" seat, open arms, no arm caps, multi-upholstery, grade 2 vinyl seat and grade 7 fabric back

METAL 3-SEAT :: \$3,551

Metal frame, 24" seat, center arm, open arms, polyurethane arm caps, multi-upholstery, grade 4 vinyl seat and grade 2 fabric back

Features

- Easy ingress and egress with waterfall seat design
- Clean-out space
- Steel-frame construction with metal-to-metal connections
- Beveled, wall-saving frame design
- Two frame materials: Durable aluminum frame or wood frame with silver ion anti-microbial finish
- Three metal frame finishes or four wood frame finishes
- Polyurethane, wood or solid surface arm caps
- Replaceable parts including seat, back, arms, arm caps and arm insets.
- 2-Seat: 525 lb weight capacity warranty
3-Seat: 750 lb weight capacity warranty

1. Product

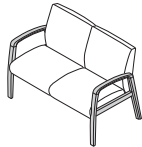
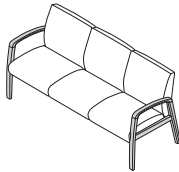
Model	Code	Price	
Aviera 2-Seat Freespan	VRF SN2	\$1,830	
Aviera 3-Seat Freespan	VRF SN3	\$2,731	

FREESPAN MULTISEATING

2. Frame

Frame Material	Code	Price	
Metal	FM3	+ \$0	
Wood			
Beech	FM2	+ \$10	
Maple	FM1	+ \$68	
Center Arm	Code	Price	
No Center Arm	AC0	+ \$0	

2-Seat With Center Arm	AC1	+ \$30	
------------------------	-----	--------	---

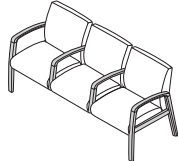
3-Seat With Center Arm	AC1	+ \$60	
------------------------	-----	--------	---

Frame Finish	Code	Price	
For Metal Frame			
Silver Metallic	FCM1	+ \$0	
Graphite	FCM2	+ \$0	
Taupe	FCM3	+ \$0	

For Wood Frame			
Clear Maple	FCW1	+ \$0	
Medium Cherry	FCW2	+ \$0	
Amber Mahogany	FCW3	+ \$0	
Espresso	FCW4	+ \$0	
Stain-to-Match	STM	+ \$70	

Frame Options	Code	Price	
Protective Guard Clear Tape	FX1	+ \$84	

Stain-to-Match (STM) requires a one-time set up fee of \$275.

Upholstered arm textile will match seat textile.

3. Seat

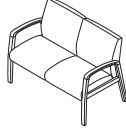
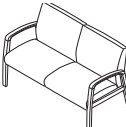
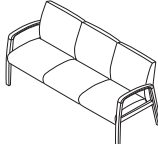
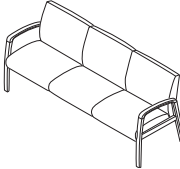
Seat Width	Code	Price	
21", 2-Seat (525 lb Weight Capacity)	SW21	+ \$0	
24", 2-Seat (525 lb Weight Capacity)	SW24	+ \$130	
21", 3-Seat (750 lb Weight Capacity)	SW21	+ \$0	
24", 3-Seat (750 lb Weight Capacity)	SW24	+ \$195	

See the Super Duty Guide on [page 626](#) for additional high weight capacity products.

4. Arms

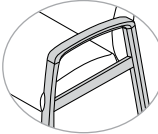
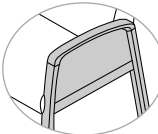
Arm Type	Code	Price	
Open Arm	AT1	+ \$0	
Upholstered Arm, 2-Seat No Center Arm	AT2	+ \$86	
Upholstered Arm, 2-Seat With Center Arm	AT2	+ \$129	
Upholstered Arm, 3-Seat No Center Arm	AT2	+ \$86	
Upholstered Arm, 3-Seat With Center Arm	AT2	+ \$172	

Upholstered arm textile will match seat textile.

FREESPAN MULTISEATING

4. Arms (Cont.)

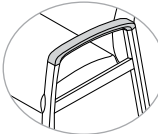
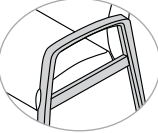
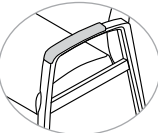
Arm Cap Material	Code	Price	
For Metal Frame			
Polyurethane	ACP4	+ \$0	
Wood, No Center Arm	ACP3	+ \$120	
Wood, 2-Seat With Center Arm	ACP3	+ \$180	
Wood, 3-Seat With Center Arm	ACP3	+ \$240	
Solid Surface, No Center Arm	ACP5	+ \$500	
Solid Surface, 2-Seat With Center Arm	ACP5	+ \$750	
Solid Surface, 3-Seat With Center Arm	ACP5	+ \$1,000	
For Wood Frame			
No Arm Cap	ACP0	+ \$0	
Polyurethane, No Center Arm	ACP2	+ \$120	
Polyurethane, 2-Seat With Center Arm	ACP2	+ \$180	
Polyurethane, 3-Seat With Center Arm	ACP2	+ \$240	
Arm Cap Finish	Code	Price	
For Polyurethane Arm Caps			
Black	RMC3	+ \$0	
Fog	RMC4	+ \$0	
Dark Grey	RMC5	+ \$0	
For Wood Arm Caps			
Clear Maple	FCW1	+ \$0	
Medium Cherry	FCW2	+ \$0	
Amber Mahogany	FCW3	+ \$0	
Espresso	FCW4	+ \$0	
Stain-to-Match	STM	+ \$70	
For Solid Surface Arm Caps			
Designer White	TSS2	+ \$0	

Stain-to-Match (STM) requires a one-time set up fee of \$275.

5. Material

Protection	Code	Price	
Fire Retardancy		2-Seat	3-Seat
CAL 133	UCAL	+ \$200	+ \$300
Cleaning	Code	Price	
Moisture Barrier		2-Seat	3-Seat
Seat Only	UM2	+ \$130	+ \$195
Back Only	UM1	+ \$130	+ \$195
Seat and Back	UM3	+ \$260	+ \$390
Fully Upholstered	Code	Price	
Seat and Back Textile		2-Seat	3-Seat
Fabric/Vinyl Grade 1	FG1/VG1	+ \$0	+ \$0
COM	COM	+ \$120	+ \$180
Fabric/Vinyl Grade 2	FG2/VG2	+ \$120	+ \$180
Fabric/Vinyl Grade 3	FG3/VG3	+ \$300	+ \$450
Fabric/Vinyl Grade 4	FG4/VG4	+ \$550	+ \$825
Fabric/Vinyl Grade 5	FG5/VG5	+ \$830	+ \$1,245
Fabric/Vinyl Grade 6	FG6/VG6	+ \$1,150	+ \$1,725
Fabric/Vinyl Grade 7	FG7/VG7	+ \$1,470	+ \$2,205
Leather Grade 1	LG1	+ \$1,200	+ \$1,800
COL	COL	+ \$1,400	+ \$2,100
Leather Grade 2	LG2	+ \$1,400	+ \$2,100
Leather Grade 3	LG3	+ \$1,600	+ \$2,400
Multi-Upholstery	Code	Price	
		2-Seat	3-Seat
Multi-Upholstery Upcharge	UMU	+ \$113	+ \$113
Seat Textile Only		2-Seat	3-Seat
Fabric/Vinyl Grade 1	FG1/VG1	+ \$0	+ \$0
COM	COM	+ \$51	+ \$76
Fabric/Vinyl Grade 2	FG2/VG2	+ \$51	+ \$76
Fabric/Vinyl Grade 3	FG3/VG3	+ \$126	+ \$189
Fabric/Vinyl Grade 4	FG4/VG4	+ \$231	+ \$347
Fabric/Vinyl Grade 5	FG5/VG5	+ \$349	+ \$523
Fabric/Vinyl Grade 6	FG6/VG6	+ \$483	+ \$725
Fabric/Vinyl Grade 7	FG7/VG7	+ \$618	+ \$927
Leather Grade 1	LG1	+ \$504	+ \$756
COL	COL	+ \$588	+ \$882
Leather Grade 2	LG2	+ \$588	+ \$882
Leather Grade 3	LG3	+ \$672	+ \$1,008

FREESPAN MULTISEATING

5. Material (Cont.)

Multi-Upholstery	Code	Price	
Back Textile Only		2-Seat	3-Seat
Fabric/Vinyl Grade 1	FG1/VG1	+ \$0	+ \$0
COM	COM	+ \$70	+ \$105
Fabric/Vinyl Grade 2	FG2/VG2	+ \$70	+ \$105
Fabric/Vinyl Grade 3	FG3/VG3	+ \$174	+ \$261
Fabric/Vinyl Grade 4	FG4/VG4	+ \$319	+ \$479
Fabric/Vinyl Grade 5	FG5/VG5	+ \$482	+ \$723
Fabric/Vinyl Grade 6	FG6/VG6	+ \$667	+ \$1,001
Fabric/Vinyl Grade 7	FG7/VG7	+ \$853	+ \$1,279
Leather Grade 1	LG1	+ \$696	+ \$1,044
COL	COL	+ \$812	+ \$1,218
Leather Grade 2	LG2	+ \$812	+ \$1,218
Leather Grade 3	LG3	+ \$928	+ \$1,392

Upholstery prices apply to both 21" and 24" models.

If different fabrics are selected for the seat and back, add the multi-upholstery upcharge as well, even if the fabrics are the same grade.

Please reference the [Textile Reference Guide](#) for pricing on fabric over grade 7 and leather over grade 3. Additional CAL 133 information can be found on [page 15](#).

6. Options

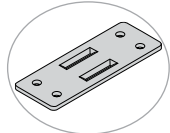
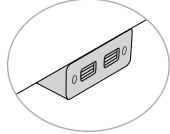
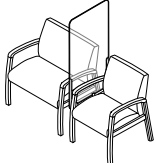
Ganging Brackets	Code	Price	
Ganging Brackets	XGV	+ \$103	
Power Options	Code	Price	
Power, Left	PFL	+ \$250	
Power, Right	PFR	+ \$250	
Sector Seating Screen	3097 XRX	+ \$460	

7. Packaging

Packaging	Code	Price
Fully Assembled in a Carton	P1	+ \$0

2-SEAT SPECIFICATIONS

Model:	21"	24"
Dimensions		
Height	34.5"	34.5"
Width	46.39" (AC0) 47.28" (AC1)	52.39" (AC0) 53.28" (AC1)
Depth	26.5"	26.5"
Arm Height (Height of Arms From Floor)	25.75"	25.75"
Arm Height (From Seat to Top of Arm)	7.25"	7.25"
Width Between Arms	42.64" (AC0) 20.75" (AC1)	48.64" (AC0) 23.75" (AC1)
Seat Width	21.75"	24.75"
Seat Depth	19"	19"
Seat Height	18.5"	18.5"
Back Height	18.5"	18.5"
Materials		
COM (Fully Upholstered)	3.8 yd	4.3 yd
COM (Multi-Upholstery)		
Seat Only	1.9 yd	2.2 yd
Back Only	2.1 yd	3.1 yd
COL (Fully Upholstered)	58 sq ft	86 sq ft
Weight and Capacity		
Weight	81 lb (FM3+AC0)	84 lb (FM3+AC0)
	85 lb (FM3+AC1)	88 lb (FM3+AC1)
	76 lb (FM1/FM2+AC0)	79 lb (FM1/FM2+AC0)
	79 lb (FM1/FM2+AC1)	82 lb (FM1/FM2+AC1)
Weight Capacity Warranty	525 lb	525 lb

Metal frame (FM3). Beech wood frame (FM2), Maple wood frame (FM2).
No center arms (AC0). Center arm (AC1).

Yardage requirements for COM and COL are for solid and non-directional fabrics. Additional material may be required for larger repeating patterns.

FREESPAN MULTISEATING

3-SEAT SPECIFICATIONS

Model:	21"	24"
Dimensions		
Height	34.5"	34.5"
Width	68.27" (AC0) 70.03" (AC1)	77.27" (AC0) 79.03" (AC1)
Depth	26.5"	26.5"
Arm Height (Height of Arms From Floor)	25.75"	25.75"
Arm Height (From Seat to Top of Arm)	7.25"	7.25"
Width Between Arms	64.52" (AC0) 20.75" (AC1)	73.52" (AC0) 23.75" (AC1)
Seat Width	21.75"	24.75"
Seat Depth	19"	19"
Seat Height	18.5"	18.5"
Back Height	18.5"	18.5"
Materials		
COM (Fully Upholstered)	5.6 yd	5.9 yd
COM (Multi-Upholstery)		
Seat Only	3 yd	3 yd
Back Only	3.1 yd	4.7 yd
COL (Fully Upholstered)	88.2 sq ft	93 sq ft
Weight and Capacity		
Weight	104 lb (FM3+AC0)	109 lb (FM3+AC0)
	110 lb (FM3+AC1)	117 lb (FM3+AC1)
	99 lb (FM1/FM2+AC0)	104 lb (FM1/FM2+AC0)
	105 lb (FM1/FM2+AC1)	110 lb (FM1/FM2+AC1)
Weight Capacity Warranty	750 lb	750 lb

Metal frame (FM3). Beech wood frame (FM2), Maple wood frame (FM3).
No center arms (AC0). Center arms (AC1).

Yardage requirements for COM and COL are for solid and non-directional fabrics. Additional material may be required for larger repeating patterns.



Metal 3-Seat

Aviera

PRECONFIGURED TANDEM MULTISEATING

Comfort that lasts.

Whether lobby, lounge, welcoming or waiting, you can rest easy with supremely comfortable do-it-all seating for your public spaces. Aviera makes it easy to configure endlessly and effortlessly—across an entire collection—with worry-free design and lasting durability, including metal or wood frames that feature an integrated steel structure. Discover an industry-leading seating solution and get peace-of-mind for any project.



Metal 2-Seat

EFFECTIVE NOVEMBER 4, 2024

Featured Models

METAL 2-SEAT :: \$2,867

Metal frame, 21" seat, open arms, polyurethane arm caps, multi-upholstery, grade 4 vinyl seat and grade 5 vinyl back

WOOD 2-SEAT :: \$3,160

Maple frame, 21" seat, open arms, no arm caps, multi-upholstery, grade 2 vinyl seat and grade 7 fabric back

METAL 3-SEAT :: \$4,367

Metal frame, 21" seat, open arms, polyurethane arm caps, multi-upholstery, grade 1 vinyl seat and grade 7 vinyl back

Features

- Easy ingress and egress with waterfall seat design
- Clean-out space
- Steel-frame construction with metal-to-metal connections
- Beveled, wall-saving frame design
- Two frame materials: Durable aluminum frame or wood frame with silver ion anti-microbial finish
- Three metal frame finishes or four wood frame finishes
- Polyurethane, wood or solid surface arm caps
- Replaceable parts including seat, back, arms, arm caps and arm insets.
- 500 lb weight capacity (per seat) warranty

1. Product

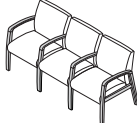
Model	Code	Price	
Aviera 2-Seat Preconfigured	VRC SN2	\$2,041	
Aviera 3-Seat Preconfigured	VRC SN3	\$2,975	

PRECONFIGURED TANDEM MULTISEATING

2. Frame

Frame Material	Code	Price	
Metal	FM3	+ \$0	
Wood			
Beech 2-Seat	FM2	+ \$15	
Beech 3-Seat	FM2	+ \$20	
Maple 2-Seat	FM1	+ \$102	
Maple 3-Seat	FM1	+ \$136	
Frame Finish	Code	Price	
For Metal Frame			
Silver Metallic	FCM1	+ \$0	
Graphite	FCM2	+ \$0	
Taupe	FCM3	+ \$0	
For Wood Frame			
Clear Maple	FCW1	+ \$0	
Medium Cherry	FCW2	+ \$0	
Amber Mahogany	FCW3	+ \$0	
Espresso	FCW4	+ \$0	
Stain-to-Match	STM	+ \$70	
Frame Options	Code	Price	
Protective Guard Clear Tape, 2-Seat	FX1	+ \$126	
Protective Guard Clear Tape, 3-Seat	FX1	+ \$168	

Stain-to-Match (STM) requires a one-time set up fee of \$275.

3. Back

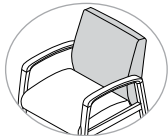

Back Height	Code	Price	
Guest Back	BH1	+ \$0	

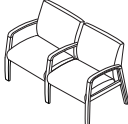
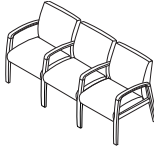
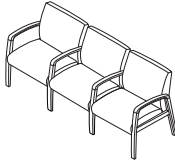
4. Seat

Seat Width	Code	Price	
21", 2-Seat (500 lb Weight Capacity, Per Seat)	SW21	+ \$0	
24", 2-Seat (500 lb Weight Capacity, Per Seat)	SW24	+ \$130	
21", 3-Seat (500 lb Weight Capacity, Per Seat)	SW21	+ \$0	
24", 3-Seat (500 lb Weight Capacity, Per Seat)	SW24	+ \$195	

See the Super Duty Guide on [page 626](#) for additional high weight capacity products.

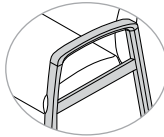
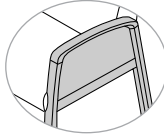
5. Arms

Arm Type	Code	Price	
Open Arm	AT1	+ \$0	
Upholstered Arm, 2-Seat	AT2	+ \$129	
Upholstered Arm, 3-Seat	AT2	+ \$172	

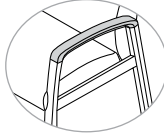
Arm Cap Material	Code	Price	
For Metal Frame			
Polyurethane	ACP4	+ \$0	
Wood, 2-Seat	ACP3	+ \$180	
Wood, 3-Seat	ACP3	+ \$240	
Solid Surface, 2-Seat	ACP5	+ \$750	
Solid Surface, 3-Seat	ACP5	+ \$1,000	

Upholstered arm textile will match seat textile.

PRECONFIGURED TANDEM MULTISEATING

5. Arms (Cont.)

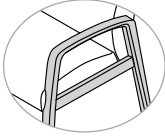
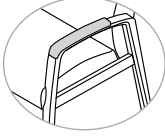
Arm Cap Material	Code	Price	
For Wood Frame			
No Arm Cap	ACP0	+ \$0	
Polyurethane, 2-Seat	ACP2	+ \$180	
Polyurethane, 3-Seat	ACP2	+ \$240	

Arm Cap Finish	Code	Price	
For Polyurethane Arm Caps			
Black	RMC3	+ \$0	
Fog	RMC4	+ \$0	
Dark Grey	RMC5	+ \$0	
For Wood Arm Caps			
Clear Maple	FCW1	+ \$0	
Medium Cherry	FCW2	+ \$0	
Amber Mahogany	FCW3	+ \$0	
Espresso	FCW4	+ \$0	
Stain-to-Match	STM	+ \$70	
For Solid Surface Arm Caps			
Designer White	TSS2	+ \$0	

Stain-to-Match (STM) requires a one-time set up fee of \$275.

6. Material

Protection	Code	Price	
Fire Retardancy		2-Seat	3-Seat
CAL 133	UCAL	+ \$200	+ \$300
Cleaning		Price	
Moisture Barrier		2-Seat	3-Seat
Seat Only	UM2	+ \$130	+ \$195
Back Only	UM1	+ \$130	+ \$195
Seat and Back	UM3	+ \$260	+ \$390
Fully Upholstered	Code	Price	

6. Material (Cont.)

Seat and Back Textile		2-Seat	3-Seat
Fabric/Vinyl Grade 1	FG1/VG1	+ \$0	+ \$0
COM	COM	+ \$120	+ \$180
Fabric/Vinyl Grade 2	FG2/VG2	+ \$120	+ \$180
Fabric/Vinyl Grade 3	FG3/VG3	+ \$300	+ \$450
Fabric/Vinyl Grade 4	FG4/VG4	+ \$550	+ \$825
Fabric/Vinyl Grade 5	FG5/VG5	+ \$830	+ \$1,245
Fabric/Vinyl Grade 6	FG6/VG6	+ \$1,150	+ \$1,725
Fabric/Vinyl Grade 7	FG7/VG7	+ \$1,470	+ \$2,205
Leather Grade 1	LG1	+ \$1,200	+ \$1,800
COL	COL	+ \$1,400	+ \$2,100
Leather Grade 2	LG2	+ \$1,400	+ \$2,100
Leather Grade 3	LG3	+ \$1,600	+ \$2,400

Multi-Upholstery	Code	Price	
		2-Seat	3-Seat
Multi-Upholstery Upcharge	UMU	+ \$113	+ \$113

Seat Textile Only		2-Seat	3-Seat
Fabric/Vinyl Grade 1	FG1/VG1	+ \$0	+ \$0
COM	COM	+ \$51	+ \$76
Fabric/Vinyl Grade 2	FG2/VG2	+ \$51	+ \$76
Fabric/Vinyl Grade 3	FG3/VG3	+ \$126	+ \$189
Fabric/Vinyl Grade 4	FG4/VG4	+ \$231	+ \$347
Fabric/Vinyl Grade 5	FG5/VG5	+ \$349	+ \$523
Fabric/Vinyl Grade 6	FG6/VG6	+ \$483	+ \$725
Fabric/Vinyl Grade 7	FG7/VG7	+ \$618	+ \$927
Leather Grade 1	LG1	+ \$504	+ \$756
COL	COL	+ \$588	+ \$882
Leather Grade 2	LG2	+ \$588	+ \$882
Leather Grade 3	LG3	+ \$672	+ \$1,008

PRECONFIGURED TANDEM MULTISEATING

6. Material (Cont.)

Multi-Upholstery	Code	Price	
		2-Seat	3-Seat
Back Textile Only			
Fabric/Vinyl Grade 1	FG1/VG1	+ \$0	+ \$0
COM	COM	+ \$70	+ \$105
Fabric/Vinyl Grade 2	FG2/VG2	+ \$70	+ \$105
Fabric/Vinyl Grade 3	FG3/VG3	+ \$174	+ \$261
Fabric/Vinyl Grade 4	FG4/VG4	+ \$319	+ \$479
Fabric/Vinyl Grade 5	FG5/VG5	+ \$482	+ \$723
Fabric/Vinyl Grade 6	FG6/VG6	+ \$667	+ \$1,001
Fabric/Vinyl Grade 7	FG7/VG7	+ \$853	+ \$1,279
Leather Grade 1	LG1	+ \$696	+ \$1,044
COL	COL	+ \$812	+ \$1,218
Leather Grade 2	LG2	+ \$812	+ \$1,218
Leather Grade 3	LG3	+ \$928	+ \$1,392

Upholstery prices apply to both 21" and 24" models.

If different fabrics are selected for the seat and back, add the multi-upholstery upcharge as well, even if the fabrics are the same grade.

Please reference the [Textile Reference Guide](#) for pricing on fabric over grade 7 and leather over grade 3. Additional CAL 133 information can be found on [page 15](#).

7. Options

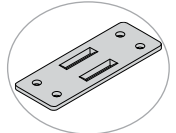
Ganging Brackets	Code	Price	
Ganging Brackets	XGV	+ \$103	

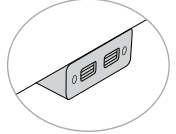
Power Options			
Power, Left	PFL	+ \$250	
Power, Right	PFR	+ \$250	

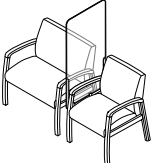
Sector Seating Screen	3097 XRX	+ \$460	
-----------------------	----------	---------	---

8. Packaging

Packaging	Code	Price	
		2-Seat	3-Seat
Packaging Options			
Final Assembly Required	P3	+ \$0	+ \$0
Fully Assembled in a Carton	P1	+ \$200	+ \$325

PRECONFIGURED TANDEM MULTISEATING

SPECIFICATIONS: 2-SEAT

Model:	21"	24"
Dimensions		
Height	34.5"	34.5"
Width	47.19"	53.19"
Depth	26.5"	26.5"
Arm Height (Height of Arms From Floor)	25.75"	25.75"
Arm Height (From Seat to Top of Arm)	7.25"	7.25"
Width Between Arms	20.75"	23.75"
Seat Width	21.75"	24.75"
Seat Depth	19"	19"
Seat Height	18.5"	18.5"
Back Height	18.5"	18.5"
Materials		
COM (Fully Upholstered)	3.8 yd	4.3 yd
COM (Multi-Upholstery)		
Seat Only	1.9 yd	2.2 yd
Back Only	2.1 yd	3.1 yd
COL (Fully Upholstered)	58 sq ft	86 sq ft
Weight and Capacity		
Weight	38 lb (FM3) 33 lb (FM1/FM2)	40 lb (FM3) 35 lb (FM1/FM2)
Weight Capacity (Per Seat) Warranty	500 lb	500 lb

Metal frame (FM3). Beech wood frame (FM2), Maple wood frame (FM1).

Yardage requirements for COM and COL are for solid and non-directional fabrics. Additional material may be required for larger repeating patterns.

SPECIFICATIONS: 3-SEAT

Model:	21"	24"
Dimensions		
Height	34.5"	34.5"
Width	69.85"	78.85"
Depth	26.5"	26.5"
Arm Height (Height of Arms From Floor)	25.75"	25.75"
Arm Height (From Seat to Top of Arm)	7.25"	7.25"
Width Between Arms	20.75"	20.75"
Seat Width	21.75"	24.75"
Seat Depth	19"	19"
Seat Height	18.5"	18.5"
Back Height	18.5"	18.5"
Materials		
COM (Fully Upholstered)	5.6 yd	5.9 yd
COM (Multi-Upholstery)		
Seat Only	3 yd	3 yd
Back Only	3.1 yd	4.7 yd
COL (Fully Upholstered)	88.2 sq ft	93 sq ft
Weight and Capacity		
Weight	99 lb (FM3) 89 lb (FM1/FM2)	104 lb (FM3) 94 lb (FM1/FM2)
Weight Capacity (Per Seat) Warranty	500 lb	500 lb

Metal frame (FM3). Beech wood frame (FM2), Maple wood frame (FM1).

Yardage requirements for COM and COL are for solid and non-directional fabrics. Additional material may be required for larger repeating patterns.



Wood 2-Seat

Aviera

START/CENTER/END TANDEM MULTISEATING

Comfort that lasts.

Whether lobby, lounge, welcoming or waiting, you can rest easy with supremely comfortable do-it-all seating for your public spaces. Aviera makes it easy to configure endlessly and effortlessly—across an entire collection—with worry-free design and lasting durability, including metal or wood frames that feature an integrated steel structure. Discover an industry-leading seating solution and get peace-of-mind for any project.

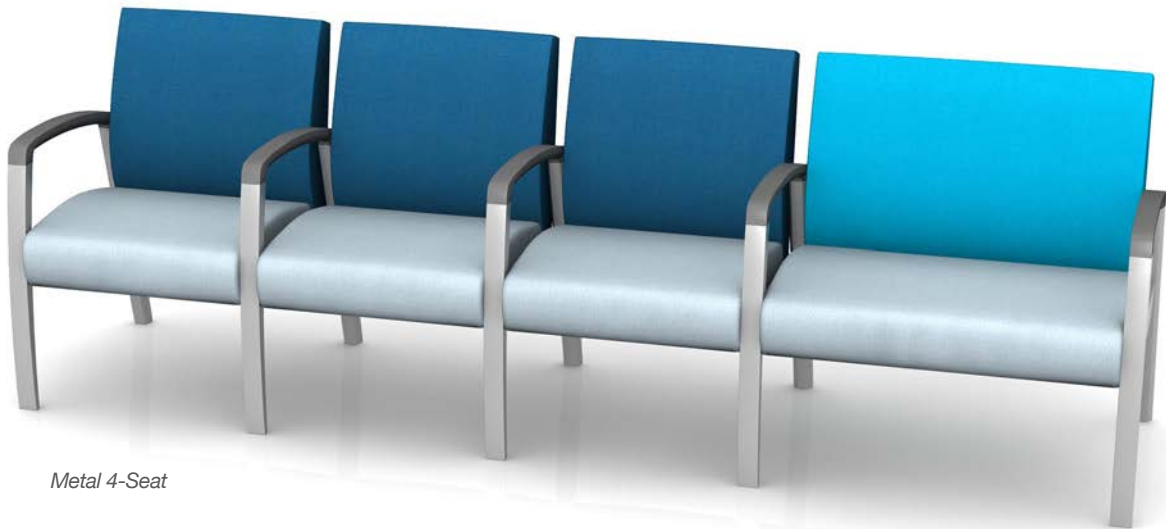

Metal 4-Seat

EFFECTIVE NOVEMBER 4, 2024

Featured Models

METAL 3-SEAT :: \$4,273

One 21" start, one 30" center, one 21" end, metal frame, open arms, polyurethane arm caps, multi-upholstery, grade 3 vinyl seat and back

METAL 4-SEAT :: \$5,170

One 21" start, two 21" centers, one 30" end, metal frame, open arms, polyurethane arm caps, multi-upholstery, grade 2 vinyl seat and back

WOOD 5-SEAT :: \$7,047



One 21" start, three 21" centers, one 30" end, maple frame, open arms, no arm caps, multi-upholstery, grade 3 vinyl seat and back

START/CENTER/END TANDEM MULTISEATING

Features

- Start/center/end multiseating is the most versatile and is designed for configurations requiring more than three seats
- Easy ingress and egress with 18.5" seat height and waterfall seat design
- Clean-out space
- Steel-frame construction with metal-to-metal connections
- Beveled, wall-saving frame design
- Two frame materials: Durable aluminum frame or wood frame with silver ion anti-microbial finish
- Three metal frame finishes or four wood frame finishes
- Polyurethane, wood or solid surface arm caps
- Replaceable parts including seat, back, arms, arm caps and arm insets
- 21"/24" seat: 500 lb weight capacity warranty
30"/44" seat: 750 lb weight capacity warranty

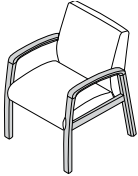
1. Product



Model	Code	Price	
Start	VRM FS4	\$1,054	
Center	VRM FS5	\$1,022	
End	VRM FS6	\$1,022	

2. Frame

Frame Material	Code	Price	
Metal	FM3	+ \$0	
Wood			
Beech, Start	FM2	+ \$10	
Maple, Start	FM1	+ \$68	
Beech, Center or End	FM2	+ \$5	
Maple, Center or End	FM1	+ \$34	
Frame Finish	Code	Price	
For Metal Frame			
Silver Metallic	FCM1	+ \$0	
Graphite	FCM2	+ \$0	
Taupe	FCM3	+ \$0	
For Wood Frame			
Clear Maple	FCW1	+ \$0	
Medium Cherry	FCW2	+ \$0	
Amber Mahogany	FCW3	+ \$0	
Espresso	FCW4	+ \$0	
Stain-to-Match	STM	+ \$70	
Frame Options			
Protective Guard Clear Tape, Start	FX1	+ \$84	
Protective Guard Clear Tape, Center/End	FX1	+ \$42	

Stain-to-Match (STM) requires a one-time set up fee of \$275.

3. Seat

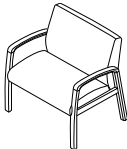
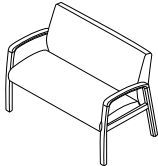
Seat Width	Code	Price	
21"	SW21	+ \$0	
24"	SW24	+ \$65	
Bariatric			
30"	SW30	+ \$315	
44"	SW44	+ \$510	

4. Back

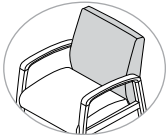
Back Height	Code	Price	
Guest Back	BH1	+ \$0	

5. Arms

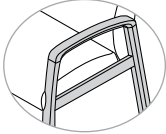
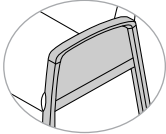
Arm Type	Code	Price	
Open Arm	AT1	+ \$0	
Upholstered Arm, Start	AT2	+ \$86	
Upholstered Arm, Center or End	AT2	+ \$43	

START/CENTER/END TANDEM MULTISEATING

5. Arms (Cont.)

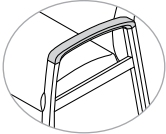
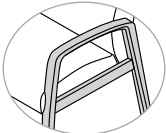
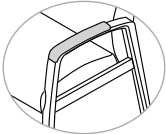
Arm Cap Material	Code	Price	
For Metal Frame			
Polyurethane	ACP4	+ \$0	
Wood, Start	ACP3	+ \$120	
Wood, Center/End	ACP3	+ \$60	
Solid Surface	ACP5	+ \$500	
Solid Surface, Center/End	ACP5	+ \$250	
For Wood Frame			
No Arm Cap	ACP0	+ \$0	
Polyurethane, Start	ACP2	+ \$120	
Polyurethane, Center/End	ACP2	+ \$60	
Arm Cap Finish	Code	Price	
For Polyurethane Arm Caps			
Black	RMC3	+ \$0	
Fog	RMC4	+ \$0	
Dark Grey	RMC5	+ \$0	
For Wood Arm Caps			
Clear Maple	FCW1	+ \$0	
Medium Cherry	FCW2	+ \$0	
Amber Mahogany	FCW3	+ \$0	
Espresso	FCW4	+ \$0	
Stain-to-Match	STM	+ \$70	
For Solid Surface Arm Caps			
Designer White	TSS2	+ \$0	

Stain-to-Match (STM) requires a one-time set up fee of \$275.

Upholstered arm textile will match seat textile.

START/CENTER/END TANDEM MULTISEATING

6. Material

Protection	Code	Price	
Fire Retardancy		21"/24"	30"/44"
CAL 133	UCAL	+ \$100	+ \$100
Cleaning	Code	Price	
Moisture Barrier		21"/24"	30"/44"
Seat Only	UM2	+ \$65	+ \$65
Back Only	UM1	+ \$65	+ \$65
Seat and Back	UM3	+ \$130	+ \$130
Fully Upholstered	Code	Price	
Seat and Back Textile		21"/24"	30"/44"
Fabric/Vinyl Grade 1	FG1/VG1	+ \$0	+ \$0
COM	COM	+ \$60	+ \$100
Fabric/Vinyl Grade 2	FG2/VG2	+ \$60	+ \$100
Fabric/Vinyl Grade 3	FG3/VG3	+ \$150	+ \$220
Fabric/Vinyl Grade 4	FG4/VG4	+ \$275	+ \$365
Fabric/Vinyl Grade 5	FG5/VG5	+ \$415	+ \$525
Fabric/Vinyl Grade 6	FG6/VG6	+ \$575	+ \$705
Fabric/Vinyl Grade 7	FG7/VG7	+ \$735	+ \$885
Leather Grade 1	LG1	+ \$600	+ \$685
COL	COL	+ \$700	+ \$805
Leather Grade 2	LG2	+ \$700	+ \$805
Leather Grade 3	LG3	+ \$800	+ \$1,005
Multi-Upholstery	Code	Price	
		21"/24"	30"/44"
Multi-Upholstery Upcharge	UMU	+ \$113	+ \$113
Seat Textile Only		21"/24"	30"/44"
Fabric/Vinyl Grade 1	FG1/VG1	+ \$0	+ \$0
COM	COM	+ \$26	+ \$42
Fabric/Vinyl Grade 2	FG2/VG2	+ \$26	+ \$42
Fabric/Vinyl Grade 3	FG3/VG3	+ \$63	+ \$93
Fabric/Vinyl Grade 4	FG4/VG4	+ \$116	+ \$154
Fabric/Vinyl Grade 5	FG5/VG5	+ \$175	+ \$221
Fabric/Vinyl Grade 6	FG6/VG6	+ \$242	+ \$297
Fabric/Vinyl Grade 7	FG7/VG7	+ \$309	+ \$372
Leather Grade 1	LG1	+ \$252	+ \$288
COL	COL	+ \$294	+ \$339
Leather Grade 2	LG2	+ \$294	+ \$339
Leather Grade 3	LG3	+ \$336	+ \$423

6. Material (Cont.)

Multi-Upholstery	Code	Price	
Back Textile Only		21"/24"	30"/44"
Fabric/Vinyl Grade 1	FG1/VG1	+ \$0	+ \$0
COM	COM	+ \$35	+ \$58
Fabric/Vinyl Grade 2	FG2/VG2	+ \$35	+ \$58
Fabric/Vinyl Grade 3	FG3/VG3	+ \$87	+ \$128
Fabric/Vinyl Grade 4	FG4/VG4	+ \$160	+ \$212
Fabric/Vinyl Grade 5	FG5/VG5	+ \$241	+ \$305
Fabric/Vinyl Grade 6	FG6/VG6	+ \$334	+ \$409
Fabric/Vinyl Grade 7	FG7/VG7	+ \$427	+ \$514
Leather Grade 1	LG1	+ \$348	+ \$398
COL	COL	+ \$406	+ \$467
Leather Grade 2	LG2	+ \$406	+ \$467
Leather Grade 3	LG3	+ \$464	+ \$583

If different fabrics are selected for the seat and back, add the multi-upholstery upcharge as well, even if the fabrics are the same grade.

Please reference the [Textile Reference Guide](#) for pricing on fabric over grade 7 and leather over grade 3. Additional CAL 133 information can be found on [page 15](#).

7. Power

Power Options	Code	Price
Power, Left	PFL	+ \$250
Power, Right	PFR	+ \$250

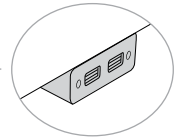

8. Packaging

Packaging	Code	Price
Fully Assembled in a Carton	P1	+ \$0

SPECIFICATIONS

Model:	21"	24"
Height	34.5"	34.5"
Width	24.5" (FS4) 22.66" (FS5/FS6)	27.5 (FS4) 25.66" (FS5/FS6)
Depth	26.5"	26.5"
Arm Height (Height of Arms From Floor)	25.75"	25.75"
Arm Height (From Seat to Top of Arm)	7.25"	7.25"
Width Between Arms	20.75"	23.75"
Seat Width	21.75"	24.75"
Seat Depth	19"	19"
Seat Height	18.5"	18.5"
Back Height	18.5"	18.5"
Weight	38 lb (FM3) 33 lb (FM1/FM2)	40 lb (FM3) 35 lb (FM1/FM2)
COM (Fully Upholstered)	1.9 yd	1.9 yd
COM (Multi-Upholstery)		
Seat Only	1.2 yd	1.2 yd
Back Only	1.1 yd	1.6 yd
COL (Fully Upholstered)	29.4 sq ft	43.4 sq ft
Weight Capacity Warranty	500 lb	500 lb

Start (FS4), Center (FS5), End (FS6), Metal frame (FM3), Beech wood frame (FM1), Maple wood frame (FM2).

Yardage requirements for COM and COL are for solid and non-directional fabrics. Additional material may be required for larger repeating patterns.

START/CENTER/END TANDEM MULTISEATING

SPECIFICATIONS: BARIATRIC SIZES

Model:	30"	44"
Height	34.5"	34.5"
Width	33.5" (FM4) 31.66" (FS5/FS6)	47.5 (FM4) 45.66" (FS5/FS6)
Depth	26.5"	26.5"
Arm Height (Height of Arms From Floor)	25.75"	25.75"
Arm Height (From Seat to Top of Arm)	7.25"	7.25"
Width Between Arms	29.75"	43.75"
Seat Width	30.75"	44.75"
Seat Depth	19"	19"
Seat Height	18.5"	18.5"
Back Height	18.5"	18.5"
Weight	50 lb (FM3+BH1) 45 lb (FM1/FM2+BH1)	77 lb (FM3+BH1) 73 lb (FM1/FM2+BH1)
COM (Fully Upholstered)	3.1 yd	3.4 yd
COM (Multi-Upholstery)		
Seat Only	1.2 yd	1.6 yd
Back Only	1.9 yd	1.9 yd
COL (Fully Upholstered)	47.6 sq ft	50.4 sq ft
Weight Capacity Warranty	750 lb	750 lb

Start (FS4), Center (FS5), End (FS6), Metal frame (FM3), Beech wood frame (FM1), Maple wood frame (FM2).

Yardage requirements for COM and COL are for solid and non-directional fabrics. Additional material may be required for larger repeating patterns.



Metal 5-Seat

Aviera

LINKING TABLES

High traffic. Low stress.

Tables are like bridges joining chairs and multiseating elements. Connect like items together or mix them up. For instance, a table can link to a guest or patient chair on one side and a preconfigured, freespan, start or end element on the other. In a start/center/end configuration, a table must connect to either a start or an end. End tables have two legs and 90° radius and square tables have one leg.



Wood Center Linking Table

EFFECTIVE NOVEMBER 4, 2024

Featured Models

WOOD CENTER LINKING TABLE :: \$784

Center linking table, maple, wood leg, maple wood veneer top and edge

METAL LEG SQUARE CORNER TABLE :: \$939

Square 90-degree corner table, metal leg, laminate top with polymer edge finish



SOLID SURFACE END TABLE :: \$1,339

End table, maple, metal leg, solid surface top and edge

Features

- Connects to Aviera Guest, Patient, and Multiseating options
- Four wood finishes and nine laminate colors
- Veener and solid surface top options

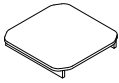
1. Appearance

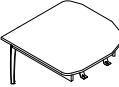
Table Type	Code	Price	
Center	VRL TTL1	\$784	
End	VRL TTL3	\$944	
Round 90-Degree Corner	VRL TTL4	\$969	
Square 90-Degree Corner	VRL TTL5	\$1,069	

2. Leg and Base

Leg and Base Material	Code	Price	
Wood	LM1	+ \$0	
Metal	LM2	+ \$0	
Leg and Base Finish	Code	Price	
Wood Finish			
Clear Maple	FCW1	+ \$0	
Medium Cherry	FCW2	+ \$0	
Amber Mahogany	FCW3	+ \$0	
Espresso	FCW4	+ \$0	
Stain-to-Match	STM	+ \$70	

Stain-to-Match (STM) requires a one-time set up fee of \$275.

LINKING TABLES

2. Leg and Base (Cont.)

Leg and Base Finish	Code	Price	
Metal Finish			
Silver Metallic	FCM1	+ \$0	
Graphite	FCM2	+ \$0	
Taupe	FCM3	+ \$0	
Leg Options	Code	Price	
Protective Guard Clear Tape (Round or Square Table Type)	LX1	+ \$21	
Protective Guard Clear Tape (End Table Type)	LX1	+ \$42	

3. Tabletop

Tabletop and Edge Material	Code	Price	
Wood and Laminate			
Laminate Top With Polymer Edge	TM3	- \$130	
Beech Wood Veneer Top and Edge	TM2	- \$60	
Maple Wood Veneer Top and Edge	TM1	+ \$0	
Solid Surface			
Center or End Table	TM4	+ \$395	
Corner Table	TM4	+ \$640	
Tabletop Finish	Code	Price	
Laminate Color			
Fusion Maple Laminate	TL1	+ \$0	
Huntington Maple Laminate	TL2	+ \$0	
Cafelle Laminate	TL4	+ \$0	
Shaker Cherry Laminate	TL5	+ \$0	
Fonthill Pear Laminate	TL6	+ \$0	
Brighton Walnut Laminate	TL7	+ \$0	
Khaki Brown Laminate	TL9	+ \$0	
Slate Laminate	TL10	+ \$0	
Black Laminate	TL12	+ \$0	
Laminate-to-Match (10+ Units)	LMM	+ \$0	
Laminate-to-Match (Under 10 Units)	LMM	+ \$300	

3. Tabletop (Cont.)

Tabletop Finish	Code	Price
Wood Finish		
Clear Maple	FCW1	+ \$0
Medium Cherry	FCW2	+ \$0
Amber Mahogany	FCW3	+ \$0
Espresso	FCW4	+ \$0
Stain-to-Match	STM	+ \$70
Solid Surface Finish		
Designer White	TSS2	+ \$0
Table Edge Finish	Code	Price
Polymer Finish		
Fusion Maple Polymer	TP1	+ \$0
Huntington Maple Polymer	TP2	+ \$0
Cafelle Polymer	TP4	+ \$0
Mocha Polymer	TP5	+ \$0
Fonthill Pear Polymer	TP6	+ \$0
Brighton Walnut Polymer	TP7	+ \$0
Khaki Brown Polymer	TP9	+ \$0
Slate Polymer	TP10	+ \$0
Black Polymer	TP12	+ \$0
Polymer-to-Match	PTM	+ \$0

Stain-to-Match (STM) requires a one-time set up fee of \$275.

If laminate top is selected, wood finish will still need to be selected in addition to laminate color. Wood finish is applied to visible understructure.

Polymer finish pairs with laminate top (TM3) only.

LINKING TABLES

4. Packaging

Packaging	Code	Price
Knocked Down	P7	+ \$0

SPECIFICATIONS

Model:	VRL TTL3 End	VRL TTL1 Center	VRL TTL5 Square 90° Corner	VRL TTL4 Round 90° Corner
Height (From Floor)	16"	16"	16"	16"
Width	21"	22"	28.4"	31"
Depth	22"	22"	28.4"	31"
Weight (Complete Assembly)	11 lb	11 lb	18 lb	18 lb
Weight (Tabletop)	6.5 lb	6.5 lb	15 lb	15 lb



Solid Surface End Table

Aviera

EFFECTIVE
NOVEMBER 4, 2024

REPLACEMENT SEATING PARTS

Replacement Parts: Arms

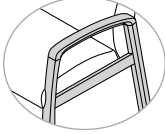
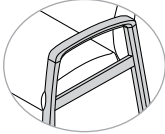
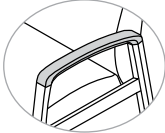
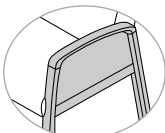
Part	Price	
Metal Arm		
Open Metal Arm, No Arm Cap	\$180	
Open Metal Arm, With Polyurethane Arm Cap	\$240	
Open Metal Arm, With Wood Arm Cap	\$300	
Open Metal Arm, With Solid Surface Arm Cap	\$705	
Open Beech Arm, No Arm Cap	\$190	
Open Maple Arm, No Arm Cap	\$210	
Arm Caps		
Polyurethane Arm Cap for Metal Frame	\$60	
Polyurethane Arm Cap for Wood Frame	\$160	
Arm Inset		
Upholstered Arm Inset	\$100	

Hip chair arms and Freespan center arms have separate pricing. All prices assume grade 1 textile. Please contact Customer Experience for additional information or to place an order.

Replacement Part: Tables

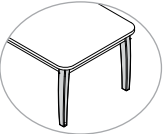
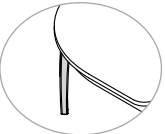
Part	Price	
Table Legs		
End Legs (2)	\$160	
Round or Square Corner Leg (1)	\$80	
Metal Leg (1)	\$120	

Replacement Part: Tables (Cont.)

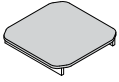
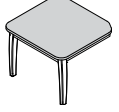
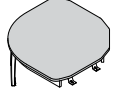
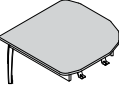
Part	Price	
Laminate Top		
Center	\$627	
End	\$680	
Round 90-Degree Corner	\$740	
Square 90-Degree Corner	\$840	

Replacement Part: Upholstered

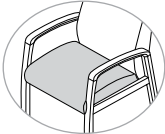
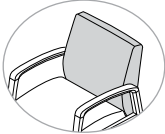
Part	Price	
Seat		
21"	\$428	
24"	\$460	
30"	\$577	
44"	\$669	
Guest Back		
21"	\$428	
24"	\$460	
30"	\$577	
44"	\$669	

All prices assume grade 1 textile. Please contact Customer Experience for additional information or to place an order.

Cameo

SEATING AND BENCHES

Design with distinction.

Tap into timeless beauty with a new take on an old classic. Cameo™ dares to move past tufted, boxy and overly square designs—both in shape and attitude. This inspired collection from world-renowned architect and designer Claudio Bellini balances perfect proportions of slenderness with just enough contouring so that it feels as good as it looks.



Seat
Featured with SitOnIt Seating's
Huntington – Tropical



Armless Seat
Featured with SitOnIt Seating's
Huntington – Splash

EFFECTIVE NOVEMBER 4, 2024

Featured Models

BENCH :: \$2,097

Cameo single seat bench, chrome base finish, grade 1 textile

ARMLESS SEAT :: \$2,278

Cameo single seat with no arms, charcoal base finish, grade 1 textile



SEAT :: \$2,503

Cameo single seat with dual arms, charcoal base finish, grade 1 textile

Features

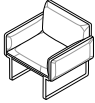
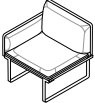
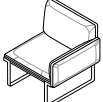
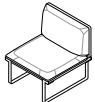

- Add a lightweight, modern look with slim ribbon leg design
- Promotes all-around comfort with contoured seat, back and arms
- Choose between single seat, 2-seater, and 3-seater seats and benches
- Design for traditional and modular configurations
- Create single-arm, dual-arm and armless configurations
- Charcoal, bronze or chrome sled-leg bases
- Designed by Claudio Bellini
- Weight capacity warranty: 400 lb for single-seater; 800 lb for 2- and 3-seater

1. Product

Model	Code	Price	
Single Seat			
Single Seat With Dual Arms	CAM SN1 FS8	\$2,503	
Single Seat With Right Arm	CAM SN1 FS10	\$2,391	
Single Seat With Left Arm	CAM SN1 FS12	\$2,391	
Single Seat Armless	CAM SN1 FS17	\$2,278	
Single Seat Bench	CAM SN1 FS2	\$1,847	

SEATING AND BENCHES

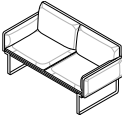
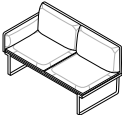
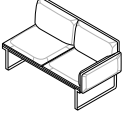
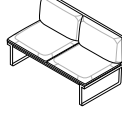
1. Product (Cont.)

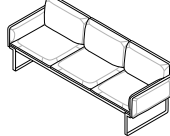
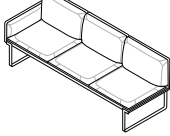
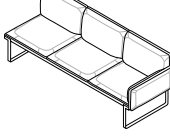
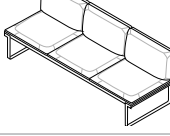
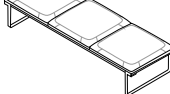
Model	Code	Price	
2-Seater			
2-Seater With Dual Arms	CAM SN2 FS8	\$3,797	
2-Seater With Right Arm	CAM SN2 FS10	\$3,684	
2-Seater With Left Arm	CAM SN2 FS12	\$3,684	
2-Seater Armless	CAM SN2 FS17	\$3,572	
2-Seater Bench	CAM SN2 FS2	\$2,578	
3-Seater			
3-Seater With Dual Arms	CAM SN3 FS8	\$4,893	
3-Seater With Right Arm	CAM SN3 FS10	\$4,781	
3-Seater With Left Arm	CAM SN3 FS12	\$4,781	
3-Seater Armless	CAM SN3 FS17	\$4,668	
3-Seater Bench	CAM SN3 FS2	\$3,675	

2. Base

Metal Finish	Code	Price
Charcoal	BF04	+ \$0
Bronze	BF05	+ \$0
Chrome	BF06	+ \$250

3. Material

Protection	Code	Price		
Fire Retardancy: Seats		1 Seat	2 Seats	3 Seats
CAL 133	UCAL	+ \$262	+ \$377	+ \$494
Fire Retardancy: Benches		1 Seat	2 Seats	3 Seats
CAL 133	UCAL	+ \$262	+ \$377	+ \$494
Cleaning	Code	Price		
Moisture Barrier: Seats		1 Seat	2 Seats	3 Seats
Seat Only	UM2	+ \$59	+ \$118	+ \$177
Back Only	UM1	+ \$59	+ \$118	+ \$177
Seat and Back	UM3	+ \$118	+ \$236	+ \$354
Moisture Barrier: Benches		1 Seat	2 Seats	3 Seats
Seat Only	UM2	+ \$59	+ \$118	+ \$177
Fully Upholstered	Code	Price		
Seat, Dual Arms		1 Seat	2 Seats	3 Seats
Fabric/Vinyl Grade 1	FG1/VG1	+ \$0	+ \$0	+ \$0
COM	COM	+ \$143	+ \$224	+ \$283
Fabric/Vinyl Grade 2	FG2/VG2	+ \$143	+ \$224	+ \$283
Fabric/Vinyl Grade 3	FG3/VG3	+ \$222	+ \$348	+ \$441
Fabric/Vinyl Grade 4	FG4/VG4	+ \$318	+ \$498	+ \$630
Fabric/Vinyl Grade 5	FG5/VG5	+ \$477	+ \$747	+ \$945
Fabric/Vinyl Grade 6	FG6/VG6	+ \$636	+ \$996	+ \$1,260
Fabric/Vinyl Grade 7	FG7/VG7	+ \$795	+ \$1,245	+ \$1,575
Leather Grade 1	LG1	+ \$1,575	+ \$2,475	+ \$2,850
COL	COL	+ \$1,995	+ \$3,135	+ \$3,610
Leather Grade 2	LG2	+ \$1,995	+ \$3,135	+ \$3,610
Leather Grade 3	LG3	+ \$2,520	+ \$3,960	+ \$4,560

SEATING AND BENCHES

3. Material (Cont.)

Fully Upholstered (Cont.)	Code	Price		
Seat, Single Arm		1 Seat	2 Seats	3 Seats
Fabric/Vinyl Grade 1	FG1/VG1	+ \$0	+ \$0	+ \$0
COM	COM	+ \$108	+ \$189	+ \$243
Fabric/Vinyl Grade 2	FG2/VG2	+ \$108	+ \$189	+ \$243
Fabric/Vinyl Grade 3	FG3/VG3	+ \$168	+ \$294	+ \$378
Fabric/Vinyl Grade 4	FG4/VG4	+ \$240	+ \$420	+ \$540
Fabric/Vinyl Grade 5	FG5/VG5	+ \$360	+ \$630	+ \$810
Fabric/Vinyl Grade 6	FG6/VG6	+ \$480	+ \$840	+ \$1,080
Fabric/Vinyl Grade 7	FG7/VG7	+ \$600	+ \$1,050	+ \$1,350
Leather Grade 1	LG1	+ \$1,200	+ \$2,175	+ \$2,625
COL	COL	+ \$1,520	+ \$2,755	+ \$3,325
Leather Grade 2	LG2	+ \$1,520	+ \$2,755	+ \$3,325
Leather Grade 3	LG3	+ \$1,920	+ \$3,480	+ \$4,200
Seat, Armless		1 Seat	2 Seats	3 Seats
Fabric/Vinyl Grade 1	FG1/VG1	+ \$0	+ \$0	+ \$0
COM	COM	+ \$81	\$162	+ \$216
Fabric/Vinyl Grade 2	FG2/VG2	+ \$81	\$162	+ \$216
Fabric/Vinyl Grade 3	FG3/VG3	+ \$126	\$252	+ \$336
Fabric/Vinyl Grade 4	FG4/VG4	+ \$180	\$360	+ \$480
Fabric/Vinyl Grade 5	FG5/VG5	+ \$270	\$540	+ \$720
Fabric/Vinyl Grade 6	FG6/VG6	+ \$360	\$720	+ \$960
Fabric/Vinyl Grade 7	FG7/VG7	+ \$450	\$900	+ \$1,200
Leather Grade 1	LG1	+ \$900	\$1,875	+ \$2,400
COL	COL	+ \$1,140	\$2,375	+ \$3,040
Leather Grade 2	LG2	+ \$1,140	\$2,375	+ \$3,040
Leather Grade 3	LG3	+ \$1,440	\$3,000	+ \$3,840
Bench		1 Seat	2 Seats	3 Seats
Fabric/Vinyl Grade 1	FG1/VG1	+ \$0	+ \$0	+ \$0
COM	COM	+ \$43	+ \$86	+ \$108
Fabric/Vinyl Grade 2	FG2/VG2	+ \$43	+ \$86	+ \$108
Fabric/Vinyl Grade 3	FG3/VG3	+ \$67	+ \$134	+ \$168
Fabric/Vinyl Grade 4	FG4/VG4	+ \$96	+ \$192	+ \$240
Fabric/Vinyl Grade 5	FG5/VG5	+ \$144	+ \$288	+ \$360
Fabric/Vinyl Grade 6	FG6/VG6	+ \$192	+ \$384	+ \$480
Fabric/Vinyl Grade 7	FG7/VG7	+ \$240	+ \$480	+ \$600
Leather Grade 1	LG1	+ \$525	+ \$1,050	+ \$1,260
COL	COL	+ \$665	+ \$1,330	+ \$1,596
Leather Grade 2	LG2	+ \$665	+ \$1,330	+ \$1,596
Leather Grade 3	LG3	+ \$840	+ \$1,680	+ \$2,016

3. Material (Cont.)

Multi-Upholstery	Code	Price		
		1 Seat	2 Seats	3 Seats
Multi-Upholstery Upcharge	UMU	+ \$75	+ \$75	+ \$75
Upholstered Seat Only		1 Seat	2 Seats	3 Seats
Fabric/Vinyl Grade 1	FG1/VG1	+ \$0	+ \$0	+ \$0
COM	COM	+ \$46	+ \$92	+ \$108
Fabric/Vinyl Grade 2	FG2/VG2	+ \$46	+ \$92	+ \$108
Fabric/Vinyl Grade 3	FG3/VG3	+ \$71	+ \$143	+ \$168
Fabric/Vinyl Grade 4	FG4/VG4	+ \$102	+ \$204	+ \$240
Fabric/Vinyl Grade 5	FG5/VG5	+ \$153	+ \$306	+ \$360
Fabric/Vinyl Grade 6	FG6/VG6	+ \$204	+ \$408	+ \$480
Fabric/Vinyl Grade 7	FG7/VG7	+ \$255	+ \$510	+ \$600
Leather Grade 1	LG1	+ \$525	+ \$1,050	+ \$1,200
COL	COL	+ \$665	+ \$1,330	+ \$1,520
Leather Grade 2	LG2	+ \$665	+ \$1,330	+ \$1,520
Leather Grade 3	LG3	+ \$840	+ \$1,680	+ \$1,920
Upholstered Back Only		1 Seat	2 Seats	3 Seats
Fabric/Vinyl Grade 1	FG1/VG1	+ \$0	+ \$0	+ \$0
COM	COM	+ \$38	+ \$76	+ \$101
Fabric/Vinyl Grade 2	FG2/VG2	+ \$38	+ \$76	+ \$101
Fabric/Vinyl Grade 3	FG3/VG3	+ \$59	+ \$118	+ \$157
Fabric/Vinyl Grade 4	FG4/VG4	+ \$84	+ \$168	+ \$225
Fabric/Vinyl Grade 5	FG5/VG5	+ \$126	+ \$252	+ \$337
Fabric/Vinyl Grade 6	FG6/VG6	+ \$168	+ \$336	+ \$450
Fabric/Vinyl Grade 7	FG7/VG7	+ \$210	+ \$420	+ \$562
Leather Grade 1	LG1	+ \$420	+ \$840	+ \$1,125
COL	COL	+ \$532	+ \$1,064	+ \$1,425
Leather Grade 2	LG2	+ \$532	+ \$1,064	+ \$1,425
Leather Grade 3	LG3	+ \$672	+ \$1,344	+ \$1,800
Upholstered Single Arm Only		1 Seat	2 Seats	3 Seats
Fabric/Vinyl Grade 1	FG1/VG1	+ \$0	+ \$0	+ \$0
COM	COM	+ \$27	+ \$27	+ \$27
Fabric/Vinyl Grade 2	FG2/VG2	+ \$27	+ \$27	+ \$27
Fabric/Vinyl Grade 3	FG3/VG3	+ \$42	+ \$42	+ \$42
Fabric/Vinyl Grade 4	FG4/VG4	+ \$60	+ \$60	+ \$60
Fabric/Vinyl Grade 5	FG5/VG5	+ \$90	+ \$90	+ \$90
Fabric/Vinyl Grade 6	FG6/VG6	+ \$120	+ \$120	+ \$120
Fabric/Vinyl Grade 7	FG7/VG7	+ \$150	+ \$150	+ \$150
Leather Grade 1	LG1	+ \$300	+ \$300	+ \$300
COL	COL	+ \$380	+ \$380	+ \$380
Leather Grade 2	LG2	+ \$380	+ \$380	+ \$380
Leather Grade 3	LG3	+ \$480	+ \$480	+ \$480

3. Material (Cont.)

Multi-Upholstery	Code	Price		
		1 Seat	2 Seats	3 Seats
Upholstered Dual Arms Only		1 Seat	2 Seats	3 Seats
Fabric/Vinyl Grade 1	FG1/VG1	+ \$0	+ \$0	+ \$0
COM	COM	+ \$54	+ \$54	+ \$54
Fabric/Vinyl Grade 2	FG2/VG2	+ \$54	+ \$54	+ \$54
Fabric/Vinyl Grade 3	FG3/VG3	+ \$84	+ \$84	+ \$84
Fabric/Vinyl Grade 4	FG4/VG4	+ \$120	+ \$120	+ \$120
Fabric/Vinyl Grade 5	FG5/VG5	+ \$180	+ \$180	+ \$180
Fabric/Vinyl Grade 6	FG6/VG6	+ \$240	+ \$240	+ \$240
Fabric/Vinyl Grade 7	FG7/VG7	+ \$300	+ \$300	+ \$300
Leather Grade 1	LG1	+ \$600	+ \$600	+ \$600
COL	COL	+ \$760	+ \$760	+ \$760
Leather Grade 2	LG2	+ \$760	+ \$760	+ \$760
Leather Grade 3	LG3	+ \$960	+ \$960	+ \$960

If different fabrics are selected for the seat and back, add the multiple upholstery upcharge (UMU) as well, even if the two fabrics are the same grade.

Please reference the [Textile Reference Guide](#) for pricing on fabric over grade 7 and leather over grade 3. Additional CAL 133 information can be found on [page 15](#).

4. Miscellaneous

Accessories	Code	Price
Ganging Bracket	CAM XGV	+ \$52

One set of gangers (2 brackets) is included in this kit and can be installed on the left or right side of a seat or bench.

These two brackets are enough to gang two upholstered units together (benches or lounge units with or without an arm on the ganged side).

The inline table (CAMT TTL1) and the corner table (CAMT TTL4) are shipped standard with a total of two sets of gangers (4 brackets) to be supported between two upholstered units.

Order multiple quantities if ganging more than two pieces together.

Note: Ganging brackets are field installed.

5. Packaging

Packaging	Code	Price
Partially Assembled in Carton	P3	+ \$0

Leg ships unattached.

SEATING AND BENCHES

SPECIFICATIONS: SEATS WITH DUAL ARMS

Model:	CAM SN1 FS8 Single-Seat	CAM SN2 FS8 2-Seater	CAM SN3 FS8 3-Seater
Dimensions			
Height	30"	30"	30"
Width	32.75"	60"	86.6"
Depth	28"	28"	28"
Seat Depth	20.25"	20.25"	20.25"
Seat Height	16.75"	16.75"	16.75"
Back Height	13.25"	13.25"	13.25"
Materials			
COM (Single Upholstery)	5 yd	7.5 yd	10.5 yd
COM (Multi-Upholstery)			
Seat Only	1.75 yd	3.25 yd	5 yd
Back Only	1.6 yd	3 yd	4.75 yd
Arms Only	2.25 yd	2.25 yd	2.25 yd
COL (Single Upholstery)	99 sq ft	147 sq ft	170 sq ft
COL (Multi-Upholstery)			
Seat Only	31 sq ft	63 sq ft	80 sq ft
Back Only	31 sq ft	57 sq ft	75 sq ft
Arms Only	42 sq ft	42 sq ft	42 sq ft
Weight and Capacity			
Weight	75 lb	116 lb	169 lb
Weight Capacity Warranty	400 lb	800 lb	800 lb

SPECIFICATIONS: ARMLESS SEATS

Model:	CAM SN1 FS17 Single-Seat	CAM SN2 FS17 2-Seater	CAM SN3 FS17 3-Seater
Dimensions			
Height	30"	30"	30"
Width	27.5"	54.5"	81.5"
Depth	28"	28"	28"
Seat Depth	20.25"	20.25"	20.25"
Seat Height	16.75"	16.75"	16.75"
Back Height	13.25"	13.25"	13.25"
Materials			
COM (Fully Upholstered)	3.25 yd	5.75 yd	8 yd
COM (Multi-Upholstery)			
Seat Only	1.75 yd	3.25 yd	5 yd
Back Only	1.6 yd	3 yd	4.75 yd
COL (Fully Upholstered)	63 sq ft	115 sq ft	130 sq ft
COL (Multi-Upholstery)			
Seat Only	31 sq ft	63 sq ft	80 sq ft
Back Only	31 sq ft	57 sq ft	75 sq ft
Weight and Capacity			
Weight	54 lb	95 lb	148 lb
Weight Capacity Warranty	400 lb	800 lb	800 lb

SPECIFICATIONS: SEATS WITH SINGLE ARM

Model:	CAM SN1 FS10 CAM SN1 FS12 Single Seat	CAM SN2 FS10 CAM SN2 FS12 2-Seater	CAM SN3 FS10 CAM SN3 FS12 3-Seater
Dimensions			
Height	30"	30"	30"
Width	30"	57"	84"
Depth	28"	28"	28"
Seat Depth	20.25"	20.25"	20.25"
Seat Height	16.75"	16.75"	16.75"
Back Height	13.25"	13.25"	13.25"
Materials			
COM (Fully Upholstered)	4 yd	6.5 yd	9 yd
COM (Multi-Upholstery)			
Seat Only	1.75 yd	3.25 yd	5 yd
Back Only	1.6 yd	3 yd	4.75 yd
Arms Only	1.25 yd	1.25 yd	1.25 yd
COL (Fully Upholstered)	78 sq ft	126 sq ft	150 sq ft
COL (Multi-Upholstery)			
Seat Only	31 sq ft	63 sq ft	80 sq ft
Back Only	31 sq ft	57 sq ft	75 sq ft
Arms Only	26 sq ft	26 sq ft	26 sq ft
Weight and Capacity			
Weight	65 lb	105 lb	159 lb
Weight Capacity Warranty	400 lb	800 lb	800 lb

SPECIFICATIONS: BENCHES

Model:	CAM SN1 FS2 Single Seat	CAM SN2 FS2 2-Seater	CAM SN3 FS2 3-Seater
Dimensions			
Height	16.75"	16.75"	16.75"
Width	27.5"	54.5"	81.5"
Depth	28"	28"	28"
Seat Depth	28"	28"	28"
Seat Height	16.75"	16.75"	16.75"
Materials			
COM (Fully Upholstered)	2 yd	3.75 yd	5 yd
COL (Fully Upholstered)	36 sq ft	68 sq ft	84 sq ft
Weight and Capacity			
Weight	35 lb	56 lb	78 lb
Weight Capacity Warranty	400 lb	800 lb	800 lb

Cameo

INLINE AND COFFEE TABLES

Design with distinction.

Too many contemporary collections promise adaptable configurations but fall short. Cameo includes a wide variety of seats, benches and tables—for traditional and modular configurations that fit any space. Something truly mod-mod (at last).



Inline Table
Featured with Skyline Walnut laminate

EFFECTIVE NOVEMBER 4, 2024

Featured Models

INLINE TABLE :: \$1,247

Cameo inline table, laminate tabletop, chrome base finish

CORNER TABLE :: \$1,328

Cameo corner table, laminate tabletop, bronze base finish

COFFEE TABLE :: \$2,478

Cameo rectangular coffee table, laminate tabletop, charcoal base finish

1. Product

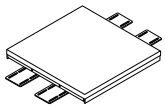
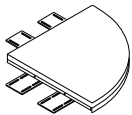
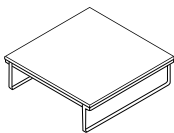
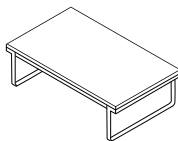
Model	Code	Price	
Inline Table	CAMT TTL1	\$997	
Corner Table	CAMT TTL4	\$1,328	
Square Coffee Table	CAMT TT8	\$2,478	
Rectangular Coffee Table	CAMT TT9	\$2,478	

The inline table (CAMT TTL1) and the corner table (CAMT TTL4) are shipped standard with a total of two sets of gangers (4 brackets) to be supported between two upholstered units.

2. Tabletop

Material	Code	Price
Laminate	TM3	+ \$0
Laminate Finish	Code	Price
Classic Linen	TL17	Priced by Size
Colombian Walnut	TL55	Priced by Size
Crisp Linen	TL64	Priced by Size
Designer White	TL66	Priced by Size
Field Elm	TL13	Priced by Size
Frosty White	TL16	Priced by Size
Grey	TL62	Priced by Size
Grey Elm	TL51	Priced by Size
Kingswood Walnut	TL53	Priced by Size
Manitoba	TL56	Priced by Size
Neo Walnut	TL50	Priced by Size
Platinum	TL61	Priced by Size
Portico Teak	TL60	Priced by Size
Skyline Walnut	TL15	Priced by Size
Steel Mesh	TL59	Priced by Size
Tuscan Walnut	TL57	Priced by Size
Uptown Walnut	TL14	Priced by Size

INLINE AND COFFEE TABLES

3. Table Base

Metal Finish	Code	Price
Charcoal	BF04	+ \$0
Bronze	BF05	+ \$0
Chrome	BF06	+ \$250

Finish also applies to the edge band.

4. Packaging

Packaging	Code	Price
Partially Assembled in Carton	P3	+ \$0

SPECIFICATIONS: LINKING TABLES

Model:	Inline Table	Corner Table
Width	27"	39.5"
Depth	28"	28.3"
Height	14.5"	14.5"
Weight	47 lb	44 lb

SPECIFICATIONS: COFFEE TABLES

Model:	Square Coffee Table	Rectangular Coffee Table
Dimensions		
Width	47.25"	47.3"
Depth	47.25"	27.8"
Height	14.5"	14.5"
Weight	120 lb	72 lb



Rectangular Coffee Table
Featured with Uptown Walnut laminate

Composium

CURVE CLUB CHAIR, SETTEE AND SOFA

Perfect harmony.

Transitional styling that blends well with collaboration areas and group housing defines Composium® Curve. This robust lounge seating collection offers three back styles, four valance styles and 11 foot styles to make it a comfortable seating choice for industrial, formal higher education or assisted living settings. Composium is rugged and easy to maintain with field-replaceable parts and durable steel-rail construction that withstands tough environments. Our PatternMatch® expertise ensures that every chair is a perfect match. Add an optional tablet arm or arm cap to create truly unique seating—just like you imagined.



Club Chair With Wood Tapered Feet

EFFECTIVE NOVEMBER 4, 2024

Featured Models

CLUB CHAIR WITH PLASTIC FEET :: \$2,246

Composium Curve club chair, square back, arched valance, black plastic feet, fully upholstered, grade 1 textile

CLUB CHAIR WITH WOOD TAPERED FEET :: \$2,386

Composium Curve club chair, square back, full valance, wood tapered square feet, fully upholstered, grade 1 textile

SETTEE WITH WOOD SIDE RAILS :: \$3,343

Composium Curve settee, square back, integrated valance, wood tapered square feet with side rails, fully upholstered, grade 3 textile

Features

- Club, settee and sofa sizes
- PatternMatch® expertise and multi-upholstery options
- Durable steel-rail construction
- Three back types — square, round and scalloped
- Four valance styles — full, integrated, three-quarter and arched
- 11 foot styles including casters, metal pole and wood
- Optional clean-out space
- Sustainable manufacturing and Take Back Program
- 300 lb weight capacity warranty per seat
- Optional power module available

1. Product

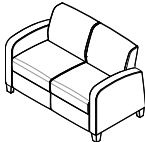
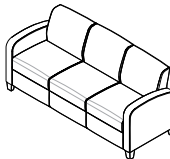
Model and Size	Code	Price	
Club	CP AS3 SN1	\$2,246	
Settee	CP AS3 SN2	\$2,910	
Sofa	CP AS3 SN3	\$3,551	

Order Composium ottoman and bench seating on page 104.

CURVE CLUB CHAIR, SETTEE AND SOFA

2. Back

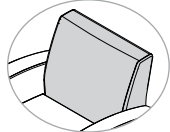
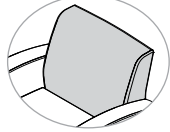
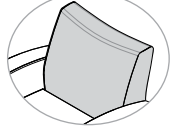
Back Shape	Code	Price	
Square	BS1	+\$0	
Round	BS2	+\$0	
Scalloped	BS3	+\$0	

3. Seat

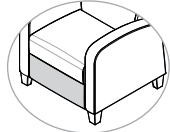
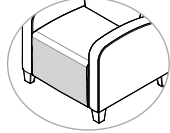
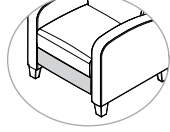
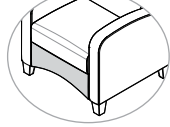
Valance Style	Code	Price	
Full	SV1	+\$0	
Integrated	SV2	+\$0	
Three-Quarter	SV3	+\$0	
Arched	SV4	+\$0	

3. Seat (Cont.)

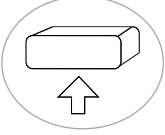
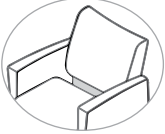
Seat Options	Code	Price	
Removable Cushion			
For Club Chair	SX1	+ \$59	
For Settee	SX1	+ \$118	
For Sofa	SX1	+ \$177	
Clean-Out			
For Club Chair	SX2	+ \$0	
For Settee	SX2	+ \$0	
For Sofa	SX2	+ \$0	





Removable cushion not available with clean-out or integrated valance.

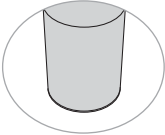
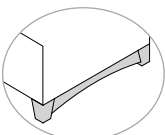
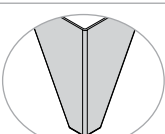
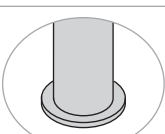
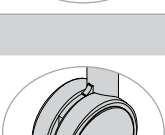
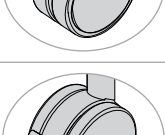
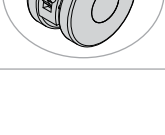

Club Chair With Plastic Feet
Featured with SitOnIt Seating's Venice – Apple

CURVE CLUB CHAIR, SETTEE AND SOFA

4. Foot

Foot Style and Color	Code	Price	
Feet			
Standard Plastic, Black	LS1	+ \$0	
Wood Tapered Square	LS12	+ \$140	
Wood Tapered Cylinder	LS11	+ \$140	
Wood Tapered Square With Side Rails	LS13	+ \$200	
Metal Angular, Brushed Aluminum	LS6	+ \$120	
Metal 1.5" Pole, Brushed Aluminum	LS7	+ \$120	
Metal 1.5" Pole, Silver Powder Coat	LS8	+ \$120	
Casters			
Non-Locking Caster, Black	LS2	+ \$100	
Non-Locking Caster, Silver	LS3	+ \$100	
Locking Caster, Black	LS4	+ \$120	
Locking Caster, Silver	LS5	+ \$120	

5. Frame (For Wooden Feet LS11/LS12/LS13)

Frame Finish Color	Code	Price	
Clear Maple	FCW1	+ \$0	
Medium Cherry	FCW2	+ \$0	
Amber Mahogany	FCW3	+ \$0	
Espresso	FCW4	+ \$0	
Stain-to-Match	STM	+ \$70	

Stain-to-Match (STM) requires a one-time set up fee of \$275.

6. Power

Power Location	Code	Price
Right Hand, Front of Unit	PFR	+ \$250
Left Hand, Front of Unit	PFL	+ \$250
Both Hands, Front of Unit	PFB	+ \$500

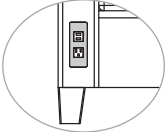
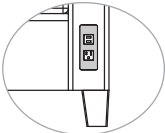
Power Color	Code	Price
Silver	PC2	+ \$0
Black	PC1	+ \$0

Power located on both hands (PFB) not available with club chair models (SN1).

7. Material

Protection	Code	Price		
Fire Retardancy		Club	Settee	Sofa
CAL 133	UCAL	+ \$262	+ \$377	+ \$494

Cleaning	Code	Price		
Moisture Barrier		Club	Settee	Sofa
Seat Only	UM2	+ \$59	+ \$118	+ \$177
Back Only	UM1	+ \$59	+ \$118	+ \$177
Seat and Back	UM3	+ \$118	+ \$236	+ \$354

Fully Upholstered	Code	Price		
Seat, Back, Arm and Valance Textile		Club	Settee	Sofa
Fabric/Vinyl Grade 1	FG1/VG1	+ \$0	+ \$0	+ \$0
COM	COM	+ \$80	+ \$105	+ \$125
Fabric/Vinyl Grade 2	FG2/VG2	+ \$80	+ \$105	+ \$125
Fabric/Vinyl Grade 3	FG3/VG3	+ \$158	+ \$233	+ \$300
Fabric/Vinyl Grade 4	FG4/VG4	+ \$263	+ \$388	+ \$500
Fabric/Vinyl Grade 5	FG5/VG5	+ \$394	+ \$582	+ \$750
Fabric/Vinyl Grade 6	FG6/VG6	+ \$578	+ \$853	+ \$1,100
Fabric/Vinyl Grade 7	FG7/VG7	+ \$814	+ \$1,202	+ \$1,550
Leather Grade 1	LG1	+ \$834	+ \$1,230	+ \$1,592
COL	COL	+ \$1,095	+ \$1,614	+ \$2,089
Leather Grade 2	LG2	+ \$1,095	+ \$1,614	+ \$2,089
Leather Grade 3	LG3	+ \$1,512	+ \$2,229	+ \$2,885

CURVE CLUB CHAIR, SETTEE AND SOFA

7. Material (Cont)

Multi-Upholstery	Code	Price		
		Club	Settee	Sofa
Multi-Upholstery Upcharge	UMU	+ \$113	+ \$113	+ \$113

Seat Textile Only		Price		
		Club	Settee	Sofa
Fabric/Vinyl Grade 1	FG1/VG1	+ \$0	+ \$0	+ \$0
COM	COM	+ \$11	+ \$18	+ \$23
Fabric/Vinyl Grade 2	FG2/VG2	+ \$11	+ \$18	+ \$23
Fabric/Vinyl Grade 3	FG3/VG3	+ \$23	+ \$42	+ \$60
Fabric/Vinyl Grade 4	FG4/VG4	+ \$39	+ \$70	+ \$100
Fabric/Vinyl Grade 5	FG5/VG5	+ \$58	+ \$105	+ \$150
Fabric/Vinyl Grade 6	FG6/VG6	+ \$84	+ \$153	+ \$220
Fabric/Vinyl Grade 7	FG7/VG7	+ \$119	+ \$215	+ \$310
Leather Grade 1	LG1	+ \$122	+ \$221	+ \$319
COL	COL	+ \$159	+ \$289	+ \$418
Leather Grade 2	LG2	+ \$159	+ \$289	+ \$418
Leather Grade 3	LG3	+ \$220	+ \$399	+ \$577

Back Textile Only		Price		
		Club	Settee	Sofa
Fabric/Vinyl Grade 1	FG1/VG1	+ \$0	+ \$0	+ \$0
COM	COM	+ \$23	+ \$34	+ \$44
Fabric/Vinyl Grade 2	FG2/VG2	+ \$23	+ \$34	+ \$44
Fabric/Vinyl Grade 3	FG3/VG3	+ \$44	+ \$84	+ \$118
Fabric/Vinyl Grade 4	FG4/VG4	+ \$72	+ \$139	+ \$197
Fabric/Vinyl Grade 5	FG5/VG5	+ \$108	+ \$209	+ \$295
Fabric/Vinyl Grade 6	FG6/VG6	+ \$159	+ \$306	+ \$432
Fabric/Vinyl Grade 7	FG7/VG7	+ \$224	+ \$430	+ \$609
Leather Grade 1	LG1	+ \$229	+ \$441	+ \$625
COL	COL	+ \$301	+ \$578	+ \$820
Leather Grade 2	LG2	+ \$301	+ \$578	+ \$820
Leather Grade 3	LG3	+ \$415	+ \$798	+ \$1,132

Arms Textile Only		Price		
		Club	Settee	Sofa
Fabric/Vinyl Grade 1	FG1/VG1	+ \$0	+ \$0	+ \$0
COM	COM	+ \$35	+ \$35	+ \$35
Fabric/Vinyl Grade 2	FG2/VG2	+ \$35	+ \$35	+ \$35
Fabric/Vinyl Grade 3	FG3/VG3	+ \$69	+ \$69	+ \$69
Fabric/Vinyl Grade 4	FG4/VG4	+ \$115	+ \$115	+ \$115
Fabric/Vinyl Grade 5	FG5/VG5	+ \$172	+ \$172	+ \$172
Fabric/Vinyl Grade 6	FG6/VG6	+ \$252	+ \$252	+ \$252
Fabric/Vinyl Grade 7	FG7/VG7	+ \$355	+ \$355	+ \$355
Leather Grade 1	LG1	+ \$364	+ \$364	+ \$364
COL	COL	+ \$477	+ \$477	+ \$477
Leather Grade 2	LG2	+ \$477	+ \$477	+ \$477
Leather Grade 3	LG3	+ \$659	+ \$659	+ \$659

7. Material (Cont.)

Multi-Upholstery (Cont.)	Code	Price		
		Club	Settee	Sofa
Valance Textile Only				
Fabric/Vinyl Grade 1	FG1/VG1	+ \$0	+ \$0	+ \$0
COM	COM	+ \$11	+ \$18	+ \$23
Fabric/Vinyl Grade 2	FG2/VG2	+ \$11	+ \$18	+ \$23
Fabric/Vinyl Grade 3	FG3/VG3	+ \$23	+ \$42	+ \$60
Fabric/Vinyl Grade 4	FG4/VG4	+ \$39	+ \$70	+ \$100
Fabric/Vinyl Grade 5	FG5/VG5	+ \$58	+ \$105	+ \$150
Fabric/Vinyl Grade 6	FG6/VG6	+ \$84	+ \$153	+ \$220
Fabric/Vinyl Grade 7	FG7/VG7	+ \$119	+ \$215	+ \$310
Leather Grade 1	LG1	+ \$122	+ \$221	+ \$319
COL	COL	+ \$159	+ \$289	+ \$418
Leather Grade 2	LG2	+ \$159	+ \$289	+ \$418
Leather Grade 3	LG3	+ \$220	+ \$399	+ \$577

If different fabrics are selected for the seat, back, arms and/or valance add the multiple upholstery upcharge (UMU) as well, even if the two fabrics are the same grade.

Please reference the [Textile Reference Guide](#) for pricing on fabric over grade 7 and leather over grade 3. Additional CAL 133 information can be found on [page 15](#).

8. Packaging

Packaging	Code	Price
Fully Assembled in a Carton	P1	+ \$0

SPECIFICATIONS

Model:	Club CP AS3 SN1	Settee CP AS3 SN2	Sofa CP AS3 SN3
Dimensions			
Height	34"	34"	34"
Width	31"	53"	75"
Depth	28"	28"	28"
Seat Width	22"	44"	66"
Seat Depth	19.5"	19.5"	19.5"
Seat Height	19.5"	19.5"	19.5"
Back Height	16"	16"	16"
Arm Height	26"	26"	26"
Materials			
COM (Fully Upholstered)	5.3 yd	7.9 yd	10.5 yd
COM (Multi-Upholstery)			
Seat Only	1.9 yd	3.2 yd	3.8 yd
Back Only	2.2 yd	4.1 yd	5.8 yd
Arms Only	3.8 yd	3.8 yd	3.8 yd
Valance Only	1 yd	1.3 yd	1.3 yd
COL (Fully Upholstered)	83.3 sq ft	122.5 sq ft	163.7 sq ft
COL (Multi-Upholstery)			
Seat Only	29.4 sq ft	49 sq ft	58.8 sq ft
Back Only	33.4 sq ft	63.7 sq ft	90.2 sq ft
Arms Only	58.8 sq ft	58.8 sq ft	58.8 sq ft
Valance Only	14.7 sq ft	19.6 sq ft	19.6 sq ft
Weight and Capacity			
Weight	70 lb	115 lb	160 lb
Weight Capacity Warranty (Per Seat)	300 lb	300 lb	300 lb

Yardage requirements for COM and COL are for solid and non-directional fabrics. Additional material may be required for larger repeating patterns.



Settee With Wood Side Rails

Composium

FLAIR CLUB CHAIR, SETTEE AND SOFA

Perfect harmony.

Composium® Flair delivers contemporary elegance via the retro flair arm style. This robust lounge seating collection offers three back styles, four valance styles and 11 foot styles to make it a comfortable seating choice, from corporate to hospitality to higher education applications. Composium is rugged and easy to maintain with field-replaceable parts and durable steel-rail construction that withstands tough environments. Our PatternMatch® expertise ensures that every chair is a perfect match. Add an optional tablet arm or arm cap to create truly unique seating—just like you imagined.



Club Chair With Metal Pole Feet

EFFECTIVE NOVEMBER 4, 2024

Featured Models

CLUB CHAIR WITH METAL POLE FEET :: \$2,441

Composium Flair club chair, scalloped back, full valance, brushed aluminum metal pole feet, fully upholstered, grade 2 vinyl

SETTEE WITH METAL POLE FEET :: \$3,030

Composium Flair settee, square back, three-quarter valance, brushed aluminum metal pole feet, fully upholstered, grade 1 textile



SOFA WITH WOOD FEET AND ARM CAPS :: \$4,313

Composium Flair sofa, square back, arched valance, wood arm caps, wood tapered square feet, fully upholstered, grade 4 textile

Features

- Club, settee and sofa sizes
- PatternMatch™ expertise and multi-upholstery options
- Durable steel-rail construction
- Three back types — square, round and scalloped
- Four valance styles — full, integrated, three-quarter and arched
- 11 foot styles including casters, metal pole and wood
- Optional clean-out space
- Optional wood arm cap and cushion
- Sustainable manufacturing and Take Back Program
- 300 lb weight capacity warranty per seat
- Optional power module available

1. Product

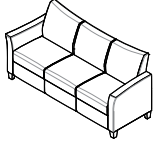
Model and Size	Code	Price	
Club	CP AS2 SN1	\$2,246	
Settee	CP AS2 SN2	\$2,910	
Sofa	CP AS2 SN3	\$3,551	

2. Arms

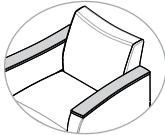
Arm Cap	Code	Price	
Wood Arm Cap	ACP1	+\$147	

FLAIR CLUB CHAIR, SETTEE AND SOFA

3. Back

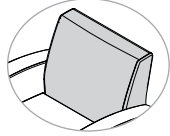
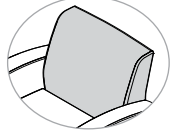
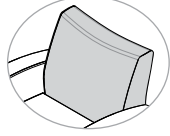
Back Shape	Code	Price	
Square	BS1	+\$0	
Round	BS2	+\$0	
Scalloped	BS3	+\$0	

4. Seat

Valance Style	Code	Price	
Full	SV1	+\$0	
Integrated	SV2	+\$0	
Three-Quarter	SV3	+\$0	
Arched	SV4	+\$0	



Removable Cushion	Code	Price	
For Club Chair	SX1	+\$59	
For Settee	SX1	+\$118	
For Sofa	SX1	+\$177	

4. Seat (Cont.)

Clean-Out	Code	Price	
For Club Chair	SX2	+ \$0	
For Settee	SX2	+ \$0	
For Sofa	SX2	+ \$0	

Removable cushion not available with clean-out or integrated valance.

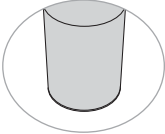
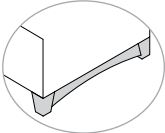
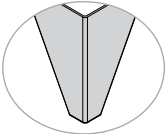
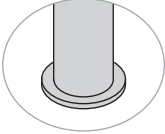
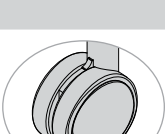
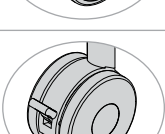
5. Foot

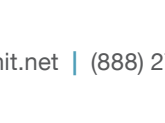
Foot Style and Color	Code	Price	
Feet			
Standard Plastic, Black	LS1	+ \$0	
Wood Tapered Square	LS12	+ \$140	
Wood Tapered Cylinder	LS11	+ \$140	
Wood Tapered Square With Side Rails	LS13	+ \$200	
Metal Angular, Brushed Aluminum	LS6	+ \$120	
Metal 1.5" Pole, Brushed Aluminum	LS7	+ \$120	
Metal 1.5" Pole, Silver Powder Coat	LS8	+ \$120	
Castors			
Non-Locking Caster, Black	LS2	+ \$100	
Non-Locking Caster, Silver	LS3	+ \$100	
Locking Caster, Black	LS4	+ \$120	
Locking Caster, Silver	LS5	+ \$120	

FLAIR CLUB CHAIR, SETTEE AND SOFA

6. Frame (For Wooden Feet LS11/LS12/LS13 or Tablet Arm AX1/AX4)

Frame Finish Color	Code	Price	
Clear Maple	FCW1	+ \$0	
Medium Cherry	FCW2	+ \$0	
Amber Mahogany	FCW3	+ \$0	
Espresso	FCW4	+ \$0	
Stain-to-Match	STM	+ \$70	

Stain-to-Match (STM) requires a one-time set up fee of \$275.

7. Power

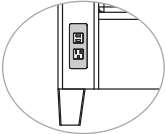
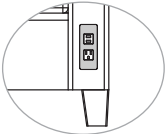
Power Location	Code	Price	
Right Hand, Front of Unit	PFR	+ \$250	
Left Hand, Front of Unit	PFL	+ \$250	
Both Hands, Front of Unit	PFB	+ \$500	
Power Color	Code	Price	
Silver	PC2	+ \$0	
Black	PC1	+ \$0	

Power located on both hands (PFB) not available with club chair models (SN1).

8. Material

Protection	Code	Price		
Fire Retardancy		Club	Settee	Sofa
CAL 133	UCAL	+ \$262	+ \$377	+ \$494
Cleaning	Code	Price		
Moisture Barrier		Club	Settee	Sofa
Seat Only	UM2	+ \$59	+ \$118	+ \$177
Back Only	UM1	+ \$59	+ \$118	+ \$177
Seat and Back	UM3	+ \$118	+ \$236	+ \$354

8. Material (Cont.)

Fully Upholstered	Code	Price		
Seat, Back, Arm and Valance Textile		Club	Settee	Sofa
Fabric/Vinyl Grade 1	FG1/VG1	+\$0	+\$0	+\$0
COM	COM	+\$75	+\$100	+\$120
Fabric/Vinyl Grade 2	FG2/VG2	+\$75	+\$100	+\$120
Fabric/Vinyl Grade 3	FG3/VG3	+\$143	+\$218	+\$285
Fabric/Vinyl Grade 4	FG4/VG4	+\$238	+\$363	+\$475
Fabric/Vinyl Grade 5	FG5/VG5	+\$357	+\$544	+\$713
Fabric/Vinyl Grade 6	FG6/VG6	+\$523	+\$798	+\$1,045
Fabric/Vinyl Grade 7	FG7/VG7	+\$737	+\$1,124	+\$1,473
Leather Grade 1	LG1	+\$758	+\$1,154	+\$1,516
COL	COL	+\$995	+\$1,515	+\$1,990
Leather Grade 2	LG2	+\$995	+\$1,515	+\$1,990
Leather Grade 3	LG3	+\$1,374	+\$2,092	+\$2,748
Multi-Upholstery	Code	Price		
		Club	Settee	Sofa
Multi-Upholstery Upcharge	UMU	+\$113	+\$113	+\$113
Seat Textile Only		Club	Settee	Sofa
Fabric/Vinyl Grade 1	FG1/VG1	+\$0	+\$0	+\$0
COM	COM	+\$10	+\$17	+\$22
Fabric/Vinyl Grade 2	FG2/VG2	+\$10	+\$17	+\$22
Fabric/Vinyl Grade 3	FG3/VG3	+\$21	+\$39	+\$57
Fabric/Vinyl Grade 4	FG4/VG4	+\$35	+\$65	+\$95
Fabric/Vinyl Grade 5	FG5/VG5	+\$52	+\$98	+\$143
Fabric/Vinyl Grade 6	FG6/VG6	+\$76	+\$143	+\$209
Fabric/Vinyl Grade 7	FG7/VG7	+\$107	+\$202	+\$295
Leather Grade 1	LG1	+\$111	+\$207	+\$304
COL	COL	+\$145	+\$271	+\$398
Leather Grade 2	LG2	+\$145	+\$271	+\$398
Leather Grade 3	LG3	+\$200	+\$375	+\$550

8. Material (Cont.)

Multi-Upholstery	Code	Price		
Back Textile Only		Club	Settee	Sofa
Fabric/Vinyl Grade 1	FG1/VG1	+\$0	+\$0	+\$0
COM	COM	+\$22	+\$33	+\$43
Fabric/Vinyl Grade 2	FG2/VG2	+\$22	+\$33	+\$43
Fabric/Vinyl Grade 3	FG3/VG3	+\$40	+\$78	+\$112
Fabric/Vinyl Grade 4	FG4/VG4	+\$66	+\$130	+\$187
Fabric/Vinyl Grade 5	FG5/VG5	+\$98	+\$195	+\$280
Fabric/Vinyl Grade 6	FG6/VG6	+\$144	+\$286	+\$410
Fabric/Vinyl Grade 7	FG7/VG7	+\$202	+\$403	+\$578
Leather Grade 1	LG1	+\$208	+\$413	+\$595
COL	COL	+\$273	+\$542	+\$781
Leather Grade 2	LG2	+\$273	+\$542	+\$781
Leather Grade 3	LG3	+\$377	+\$749	+\$1,078
Arms Textile Only		Club	Settee	Sofa
Fabric/Vinyl Grade 1	FG1/VG1	+\$0	+\$0	+\$0
COM	COM	+\$33	+\$33	+\$33
Fabric/Vinyl Grade 2	FG2/VG2	+\$33	+\$33	+\$33
Fabric/Vinyl Grade 3	FG3/VG3	+\$63	+\$63	+\$63
Fabric/Vinyl Grade 4	FG4/VG4	+\$104	+\$104	+\$104
Fabric/Vinyl Grade 5	FG5/VG5	+\$156	+\$156	+\$156
Fabric/Vinyl Grade 6	FG6/VG6	+\$228	+\$228	+\$228
Fabric/Vinyl Grade 7	FG7/VG7	+\$321	+\$321	+\$321
Leather Grade 1	LG1	+\$331	+\$331	+\$331
COL	COL	+\$434	+\$434	+\$434
Leather Grade 2	LG2	+\$434	+\$434	+\$434
Leather Grade 3	LG3	+\$599	+\$599	+\$599

8. Material (Cont.)

Multi-Upholstery	Code	Price		
		Club	Settee	Sofa
Valance Textile Only				
Fabric/Vinyl Grade 1	FG1/VG1	+ \$0	+ \$0	+ \$0
COM	COM	+ \$10	+ \$17	+ \$22
Fabric/Vinyl Grade 2	FG2/VG2	+ \$10	+ \$17	+ \$22
Fabric/Vinyl Grade 3	FG3/VG3	+ \$21	+ \$39	+ \$57
Fabric/Vinyl Grade 4	FG4/VG4	+ \$35	+ \$65	+ \$95
Fabric/Vinyl Grade 5	FG5/VG5	+ \$52	+ \$98	+ \$143
Fabric/Vinyl Grade 6	FG6/VG6	+ \$76	+ \$143	+ \$209
Fabric/Vinyl Grade 7	FG7/VG7	+ \$107	+ \$202	+ \$295
Leather Grade 1	LG1	+ \$111	+ \$207	+ \$304
COL	COL	+ \$145	+ \$271	+ \$398
Leather Grade 2	LG2	+ \$145	+ \$271	+ \$398
Leather Grade 3	LG3	+ \$200	+ \$375	+ \$550

If different fabrics are selected for the seat, back, arms and/or valance add the multiple upholstery upcharge (UMU) as well, even if the two fabrics are the same grade.

Please reference the [Textile Reference Guide](#) for pricing on fabric over grade 7 and leather over grade 3. Additional CAL 133 information can be found on [page 15](#).

9. Packaging

Packaging	Code	Price
Fully Assembled in a Carton	P1	+ \$0

SPECIFICATIONS

Model:	Club CP AS2 SN1	Settee CP AS2 SN2	Sofa CP AS2 SN3
Dimensions			
Height	34"	34"	34"
Width	33"	55"	77"
Depth	28"	28"	28"
Seat Width	22"	44"	66"
Seat Depth	19.5"	19.5"	19.5"
Seat Height	19.5"	19.5"	19.5"
Back Height	16"	16"	16"
Arm Height	26"	26"	26"
Materials			
COM (Fully Upholstered)	5.3 yd	7.9 yd	10.5 yd
COM (Multi-Upholstery)			
Seat Only	1.9 yd	3.2 yd	3.8 yd
Back Only	2.2 yd	4.1 yd	5.8 yd
Arms Only	3.8 yd	3.8 yd	3.8 yd
Valance Only	1 yd	1.3 yd	1.3 yd
COL (Fully Upholstered)	83.3 sq ft	122.5 sq ft	163.7 sq ft
COL (Multi-Upholstery)			
Seat Only	29.4 sq ft	49 sq ft	58.8 sq ft
Back Only	33.4 sq ft	63.7 sq ft	90.2 sq ft
Arms Only	58.8 sq ft	58.8 sq ft	58.8 sq ft
Valance Only	14.7 sq ft	19.6 sq ft	19.6 sq ft
Weight and Capacity			
Weight	70 lb	115 lb	160 lb
Weight Capacity Warranty (Per Seat)	300 lb	300 lb	300 lb

Yardage requirements for COM and COL are for solid and non-directional fabrics. Additional material may be required for larger repeating patterns.

Composium

SHARP CLUB CHAIR, SETTEE AND SOFA

Perfect harmony.

Composium® Sharp delivers harmonious contemporary style with straight lines and minimalist styling. This robust lounge seating collection offers three back styles, four valance styles and 11 foot styles to make it a comfortable seating choice for industrial, formal or higher education settings. Composium is rugged and easy to maintain with field-replaceable parts and durable steel-rail construction that withstands tough environments. Our PatternMatch® expertise ensures that every chair is a perfect match. Add an optional tablet arm or arm cap to create truly unique seating—just like you imagined.



*Club Chair With Plastic Feet
Featured with Momentum's Cover Cloth — Cyan*

EFFECTIVE NOVEMBER 4, 2024

Featured Models

CLUB CHAIR WITH PLASTIC FEET :: \$2,263

Composium Sharp club chair, square back, full valance, plastic feet, fully upholstered, grade 3 textile

SETTEE WITH METAL POLE FEET :: \$4,060

Composium Sharp settee, square back, three-quarter valance, brushed aluminum metal pole feet, fully upholstered, grade 7 textile

SOFA WITH WOOD SIDE RAILS :: \$5,130

Composium Sharp sofa, round back, arched valance, wood tapered square legs with side rails, fully upholstered, grade 7 textile

Features

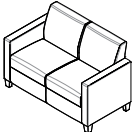
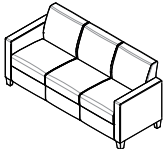

- Club, settee and sofa sizes
- PatternMatch expertise and multi-upholstery options
- Durable steel-rail construction
- Three back types — square, round and scalloped
- Four valance styles — full, integrated, three-quarter and arched
- 11 foot styles including casters, metal pole and wood
- Optional clean-out space
- Optional tablet arm and wood arm cap
- Sustainable manufacturing and Take Back Program
- 300 lb weight capacity warranty per seat
- Optional power module available

1. Product

Model and Size	Code	Price	
Club	CP AS1 SN1	\$2,113	
Settee	CP AS1 SN2	\$2,777	
Sofa	CP AS1 SN3	\$3,418	

SHARP CLUB CHAIR, SETTEE AND SOFA

2. Arms

Tablet Arm	Code	Price	
Tablet Arm, Right	AX1	+\$342	
Tablet Arm, Left	AX4	+\$342	

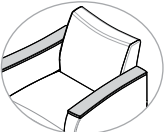
Arm Cap	Code	Price	
Wood Arm Cap	ACP1	+\$147	
Polyurethane Arm Cap	ACP2	+\$147	

Polyurethane arm (ACP2) is not available with tablet arm.

3. Back

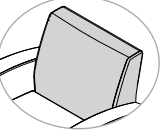
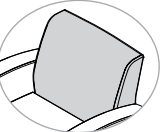
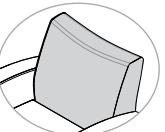
Back Shape	Code	Price	
Square	BS1	+\$0	
Round	BS2	+\$0	
Scalloped	BS3	+\$0	

COMPOSIUM SHARP

EFFECTIVE NOVEMBER 4, 2024 | GSA SIN #: 33721

4. Seat

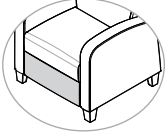
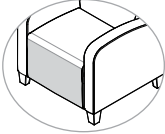
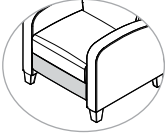
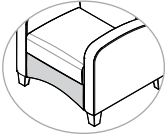
Valance Style	Code	Price	
Full	SV1	+ \$0	
Integrated	SV2	+ \$0	
Three-Quarter	SV3	+ \$0	
Arched	SV4	+ \$0	

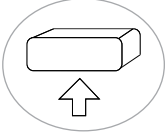



Removable Cushion	Code	Price	
For Club Chair	SX1	+ \$59	
For Settee	SX1	+ \$118	
For Sofa	SX1	+ \$177	

Clean-Out	Code	Price	
For Club Chair	SX2	+ \$0	
For Settee	SX2	+ \$0	
For Sofa	SX2	+ \$0	

Removable cushion not available with clean-out or integrated valance.

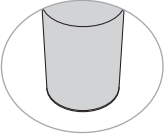
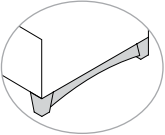
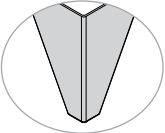
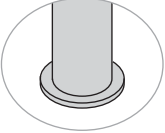
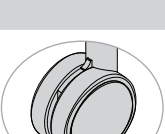
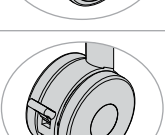
SHARP CLUB CHAIR, SETTEE AND SOFA

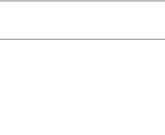
5. Foot

Foot Style and Color	Code	Price	
Feet			
Standard Plastic, Black	LS1	+ \$0	
Wood Tapered Square	LS12	+ \$140	
Wood Tapered Cylinder	LS11	+ \$140	
Wood Tapered Square With Side Rails	LS13	+ \$200	
Metal Angular, Brushed Aluminum	LS6	+ \$120	
Metal 1.5" Pole, Brushed Aluminum	LS7	+ \$120	
Metal 1.5" Pole, Silver Powder Coat	LS8	+ \$120	
Casters			
Non-Locking Caster, Black	LS2	+ \$100	
Non-Locking Caster, Silver	LS3	+ \$100	
Locking Caster, Black	LS4	+ \$120	
Locking Caster, Silver	LS5	+ \$120	

6. Frame (For Wooden Feet LS11/LS12/LS13 or Tablet Arm AX1/AX4)

Frame Finish Color	Code	Price	
Clear Maple	FCW1	+ \$0	
Medium Cherry	FCW2	+ \$0	
Amber Mahogany	FCW3	+ \$0	
Espresso	FCW4	+ \$0	
Stain-to-Match	STM	+ \$70	

Stain-to-Match (STM) requires a one-time set up fee of \$275.

COMPOSIUM SHARP

EFFECTIVE NOVEMBER 4, 2024 | GSA SIN #: 33721

7. Power

Power Location	Code	Price
Right Hand, Front of Unit	PFR	+ \$250
Left Hand, Front of Unit	PFL	+ \$250
Both Hands, Front of Unit	PFB	+ \$500

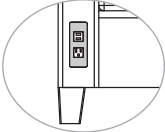
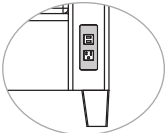
Power Color	Code	Price
Silver	PC2	+ \$0
Black	PC1	+ \$0

Power located on both hands (PFB) not available with club chair models (SN1).

8. Material

Protection	Code	Price		
Fire Retardancy		Club	Settee	Sofa
CAL 133	UCAL	+ \$262	+ \$377	+ \$494

Cleaning	Code	Price		
Moisture Barrier		Club	Settee	Sofa
Seat Only	UM2	+ \$59	+ \$118	+ \$177
Back Only	UM1	+ \$59	+ \$118	+ \$177
Seat and Back	UM3	+ \$118	+ \$236	+ \$354

Fully Upholstered	Code	Price		
Seat, Back, Arm and Valance Textile		Club	Settee	Sofa
Fabric/Vinyl Grade 1	FG1/VG1	+ \$0	+ \$0	+ \$0
COM	COM	+ \$75	+ \$100	+ \$125
Fabric/Vinyl Grade 2	FG2/VG2	+ \$75	+ \$100	+ \$125
Fabric/Vinyl Grade 3	FG3/VG3	+ \$150	+ \$225	+ \$293
Fabric/Vinyl Grade 4	FG4/VG4	+ \$250	+ \$375	+ \$488
Fabric/Vinyl Grade 5	FG5/VG5	+ \$375	+ \$563	+ \$732
Fabric/Vinyl Grade 6	FG6/VG6	+ \$550	+ \$825	+ \$1,073
Fabric/Vinyl Grade 7	FG7/VG7	+ \$775	+ \$1,163	+ \$1,512
Leather Grade 1	LG1	+ \$800	+ \$1,196	+ \$1,550
COL	COL	+ \$1,050	+ \$1,570	+ \$2,034
Leather Grade 2	LG2	+ \$1,050	+ \$1,570	+ \$2,034
Leather Grade 3	LG3	+ \$1,450	+ \$2,168	+ \$2,809

SHARP CLUB CHAIR, SETTEE AND SOFA

8. Material (Cont.)

Multi-Upholstery	Code	Price		
		Club	Settee	Sofa
Multi-Upholstery Upcharge	UMU	+ \$113	+ \$113	+ \$113

Seat Textile Only		Code	Price		
			Club	Settee	Sofa
Fabric/Vinyl Grade 1	FG1/VG1		+ \$0	+ \$0	+ \$0
COM	COM		+ \$10	+ \$17	+ \$23
Fabric/Vinyl Grade 2	FG2/VG2		+ \$10	+ \$17	+ \$23
Fabric/Vinyl Grade 3	FG3/VG3		+ \$22	+ \$41	+ \$59
Fabric/Vinyl Grade 4	FG4/VG4		+ \$37	+ \$68	+ \$98
Fabric/Vinyl Grade 5	FG5/VG5		+ \$55	+ \$101	+ \$147
Fabric/Vinyl Grade 6	FG6/VG6		+ \$80	+ \$148	+ \$215
Fabric/Vinyl Grade 7	FG7/VG7		+ \$113	+ \$209	+ \$303
Leather Grade 1	LG1		+ \$117	+ \$214	+ \$310
COL	COL		+ \$153	+ \$281	+ \$407
Leather Grade 2	LG2		+ \$153	+ \$281	+ \$407
Leather Grade 3	LG3		+ \$211	+ \$388	+ \$562

Back Textile Only		Code	Price		
			Club	Settee	Sofa
Fabric/Vinyl Grade 1	FG1/VG1		+ \$0	+ \$0	+ \$0
COM	COM		+ \$22	+ \$33	+ \$46
Fabric/Vinyl Grade 2	FG2/VG2		+ \$22	+ \$33	+ \$46
Fabric/Vinyl Grade 3	FG3/VG3		+ \$42	+ \$81	+ \$115
Fabric/Vinyl Grade 4	FG4/VG4		+ \$69	+ \$135	+ \$192
Fabric/Vinyl Grade 5	FG5/VG5		+ \$103	+ \$202	+ \$287
Fabric/Vinyl Grade 6	FG6/VG6		+ \$151	+ \$296	+ \$421
Fabric/Vinyl Grade 7	FG7/VG7		+ \$213	+ \$417	+ \$593
Leather Grade 1	LG1		+ \$220	+ \$428	+ \$608
COL	COL		+ \$288	+ \$562	+ \$798
Leather Grade 2	LG2		+ \$288	+ \$562	+ \$798
Leather Grade 3	LG3		+ \$398	+ \$776	+ \$1,102

Arms Textile Only		Code	Price		
			Club	Settee	Sofa
Fabric/Vinyl Grade 1	FG1/VG1		+ \$0	+ \$0	+ \$0
COM	COM		+ \$33	+ \$33	+ \$33
Fabric/Vinyl Grade 2	FG2/VG2		+ \$33	+ \$33	+ \$33
Fabric/Vinyl Grade 3	FG3/VG3		+ \$66	+ \$66	+ \$66
Fabric/Vinyl Grade 4	FG4/VG4		+ \$109	+ \$109	+ \$109
Fabric/Vinyl Grade 5	FG5/VG5		+ \$164	+ \$164	+ \$164
Fabric/Vinyl Grade 6	FG6/VG6		+ \$240	+ \$240	+ \$240
Fabric/Vinyl Grade 7	FG7/VG7		+ \$338	+ \$338	+ \$338
Leather Grade 1	LG1		+ \$349	+ \$349	+ \$349
COL	COL		+ \$458	+ \$458	+ \$458
Leather Grade 2	LG2		+ \$458	+ \$458	+ \$458
Leather Grade 3	LG3		+ \$632	+ \$632	+ \$632

8. Material (Cont.)

Multi-Upholstery (Cont.)	Code	Price		
		Club	Settee	Sofa
Valance Textile Only				
Fabric/Vinyl Grade 1	FG1/VG1	+ \$0	+ \$0	+ \$0
COM	COM	+ \$10	+ \$17	+ \$23
Fabric/Vinyl Grade 2	FG2/VG2	+ \$10	+ \$17	+ \$23
Fabric/Vinyl Grade 3	FG3/VG3	+ \$22	+ \$41	+ \$59
Fabric/Vinyl Grade 4	FG4/VG4	+ \$37	+ \$68	+ \$98
Fabric/Vinyl Grade 5	FG5/VG5	+ \$55	+ \$101	+ \$147
Fabric/Vinyl Grade 6	FG6/VG6	+ \$80	+ \$148	+ \$215
Fabric/Vinyl Grade 7	FG7/VG7	+ \$113	+ \$209	+ \$303
Leather Grade 1	LG1	+ \$117	+ \$214	+ \$310
COL	COL	+ \$153	+ \$281	+ \$407
Leather Grade 2	LG2	+ \$153	+ \$281	+ \$407
Leather Grade 3	LG3	+ \$211	+ \$388	+ \$562

If different fabrics are selected for the seat, back, arms and/or valance add the multiple upholstery upcharge (UMU) as well, even if the two fabrics are the same grade.

Please reference the [Textile Reference Guide](#) for pricing on fabric over grade 7 and leather over grade 3. Additional CAL 133 information can be found on [page 15](#).

9. Packaging

Packaging	Code	Price
Fully Assembled in a Carton	P1	+ \$0

SPECIFICATIONS

Model:	Club CP AS1 SN1	Settee CP AS1 SN2	Sofa CP AS1 SN3
Dimensions			
Height	34"	34"	34"
Width	31"	53"	75"
Depth	28"	28"	28"
Seat Width	22"	44"	66"
Seat Depth	19.5"	19.5"	19.5"
Seat Height	19.5"	19.5"	19.5"
Back Height	16"	16"	16"
Arm Height	26"	26"	26"
Materials			
COM (Fully Upholstered)	5.3 yd	7.9 yd	10.5 yd
COM (Multi-Upholstery)			
Seat Only	1.9 yd	3.2 yd	3.8 yd
Back Only	2.2 yd	4.1 yd	5.8 yd
Arms Only	3.8 yd	3.8 yd	3.8 yd
Valance Only	1 yd	1.3 yd	1.3 yd
COL (Fully Upholstered)	83.3 sq ft	122.5 sq ft	163.7 sq ft
COL (Multi-Upholstery)			
Seat Only	29.4 sq ft	49 sq ft	58.8 sq ft
Back Only	33.4 sq ft	63.7 sq ft	90.2 sq ft
Arms Only	58.8 sq ft	58.8 sq ft	58.8 sq ft
Valance Only	14.7 sq ft	19.6 sq ft	19.6 sq ft
Weight and Capacity			
Weight	70 lb	115 lb	160 lb
Weight Capacity Warranty (Per Seat)	300 lb	300 lb	300 lb

Yardage requirements for COM and COL are for solid and non-directional fabrics. Additional material may be required for larger repeating patterns.



Settee with Metal Pole Feet

Composium

OTTOMAN AND BENCHES

Perfect harmony.

This robust bench and ottoman collection complement all Composium® lounge seating models. Three bench sizes—plus an ottoman—provide strategic accents for a functional and modular seating solution. An optional removable cushion and 10 foot styles make this line a comfortable and stylish soft seating choice. Composium is rugged and easy to maintain with field-replaceable parts and durable steel-rail construction in benches that withstands tough environments. Our PatternMatch® expertise ensures that every chair is a perfect match.



*1-Seat Bench With Wood Feet
Featured with SitOnIt Seating's Affinity — Yellow Moss*

EFFECTIVE NOVEMBER 4, 2024

Featured Models

OTTOMAN WITH CASTERS :: \$1,218

Composium ottoman, non-locking casters, fully upholstered, grade 3 textile

1-SEAT BENCH WITH WOOD FEET :: \$1,605

Composium single-seat bench, wood tapered square feet, fully upholstered, grade 3 textile



2-SEAT BENCH WITH METAL POLE FEET :: \$1,900

Composium double-seat bench, brushed aluminum metal pole feet, fully upholstered, grade 3 vinyl

Features



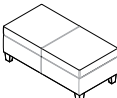
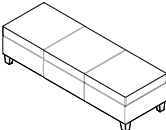

- Three bench sizes and an ottoman
- PatternMatch expertise and multi-upholstery options
- Durable steel-rail construction
- 11 foot styles including casters, metal pole and wood
- Sustainable manufacturing and Take Back Program
- 300 lb weight capacity warranty per seat
- Optional power module available

1. Product

Model	Code	Price	
Ottoman	CP FS1	\$1,050	
1-Seat Bench	CP FS2 SN1	\$1,390	
2-Seat Bench	CP FS2 SN2	\$1,690	
3-Seat Bench	CP FS2 SN3	\$1,990	

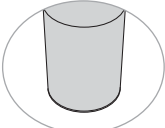
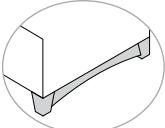
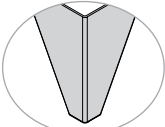
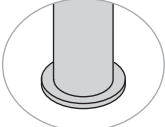
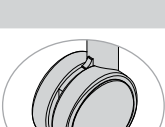
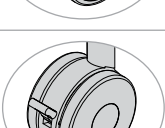
OTTOMAN AND BENCHES

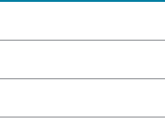
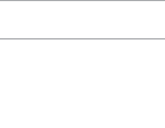
2. Foot

Foot Style and Color	Code	Price	
Feet			
Standard Plastic, Black	LS1	+ \$0	
Wood Tapered Square	LS12	+ \$140	
Wood Tapered Cylinder	LS11	+ \$140	
Wood Tapered Square With Side Rails	LS13	+ \$200	
Metal Angular, Brushed Aluminum	LS6	+ \$120	
Metal 1.5" Pole, Brushed Aluminum	LS7	+ \$120	
Metal 1.5" Pole, Silver Powder Coat	LS8	+ \$120	
Casters			
Non-Locking Caster, Black	LS2	+ \$100	
Non-Locking Caster, Silver	LS3	+ \$100	
Locking Caster, Black	LS4	+ \$120	
Locking Caster, Silver	LS5	+ \$120	

3. Frame (For Wooden Feet LS11/LS12/LS13)

Frame Finish Color	Code	Price	
Clear Maple	FCW1	+ \$0	
Medium Cherry	FCW2	+ \$0	
Amber Mahogany	FCW3	+ \$0	
Espresso	FCW4	+ \$0	
Stain-to-Match	STM	+ \$70	

Stain-to-Match (STM) requires a one-time set up fee of \$275.

OTTOMAN AND BENCHES

4. Power

Power Location	Code	Price
Right Hand, Front of Unit	PFR	+ \$250
Left Hand, Front of Unit	PFL	+ \$250
Both Hands, Front of Unit	PFB	+ \$500

Power Color	Code	Price
Silver	PC2	+ \$0
Black	PC1	+ \$0

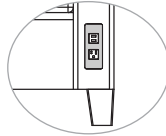
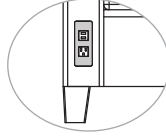

Ottoman with Casters

Power located on both hands (PFB) not available with ottoman (SN1) or single-seat bench models (SN1)

5. Material

Protection	Code	Price			
Fire Retardancy		Ottoman	1-Seat Bench	2-Seat Bench	3-Seat Bench
CAL 133	UCAL	+ \$88	+ \$88	+ \$175	+ \$262
Cleaning	Code	Price			
Moisture Barrier		Ottoman	1-Seat Bench	2-Seat Bench	3-Seat Bench
Seat Only	UM2	+ \$59	+ \$59	+ \$118	+ \$177
Fully Upholstered	Code	Price			
Seat and Valance Textile		Ottoman	1-Seat Bench	2-Seat Bench	3-Seat Bench
Fabric/Vinyl Grade 1	FG1/VG1	+ \$0	+ \$0	+ \$0	+ \$0
COM	COM	+ \$35	+ \$37	+ \$45	+ \$52
Fabric/Vinyl Grade 2	FG2/VG2	+ \$35	+ \$37	+ \$45	+ \$52
Fabric/Vinyl Grade 3	FG3/VG3	+ \$68	+ \$75	+ \$90	+ \$105
Fabric/Vinyl Grade 4	FG4/VG4	+ \$113	+ \$125	+ \$150	+ \$175
Fabric/Vinyl Grade 5	FG5/VG5	+ \$169	+ \$188	+ \$225	+ \$263
Fabric/Vinyl Grade 6	FG6/VG6	+ \$248	+ \$275	+ \$330	+ \$385
Fabric/Vinyl Grade 7	FG7/VG7	+ \$349	+ \$388	+ \$465	+ \$543
Leather Grade 1	LG1	+ \$363	+ \$371	+ \$447	+ \$523
COL	COL	+ \$476	+ \$487	+ \$586	+ \$686
Leather Grade 2	LG2	+ \$476	+ \$487	+ \$586	+ \$686
Leather Grade 3	LG3	+ \$657	+ \$672	+ \$809	+ \$947

EFFECTIVE NOVEMBER 4, 2024 | GSA SIN #: 33721

5. Material (Cont.)

Multi-Upholstery	Code	Price			
		Ottoman	1-Seat Bench	2-Seat Bench	3-Seat Bench
Multi-Upholstery Upcharge	UMU	+\$113	+\$113	+\$113	+\$113
Seat Textile Only		Ottoman	1-Seat Bench	2-Seat Bench	3-Seat Bench
Fabric/Vinyl Grade 1	FG1/VG1	+\$0	+\$0	+\$0	+\$0
COM	COM	+\$17	+\$18	+\$22	+\$26
Fabric/Vinyl Grade 2	FG2/VG2	+\$17	+\$18	+\$22	+\$26
Fabric/Vinyl Grade 3	FG3/VG3	+\$34	+\$38	+\$45	+\$53
Fabric/Vinyl Grade 4	FG4/VG4	+\$57	+\$63	+\$75	+\$88
Fabric/Vinyl Grade 5	FG5/VG5	+\$85	+\$94	+\$113	+\$132
Fabric/Vinyl Grade 6	FG6/VG6	+\$124	+\$138	+\$165	+\$193
Fabric/Vinyl Grade 7	FG7/VG7	+\$175	+\$194	+\$233	+\$272
Leather Grade 1	LG1	+\$182	+\$186	+\$224	+\$262
COL	COL	+\$238	+\$244	+\$293	+\$343
Leather Grade 2	LG2	+\$238	+\$244	+\$293	+\$343
Leather Grade 3	LG3	+\$329	+\$336	+\$405	+\$474
Valance Textile Only		Ottoman	1-Seat Bench	2-Seat Bench	3-Seat Bench
Fabric/Vinyl Grade 1	FG1/VG1	+\$0	+\$0	+\$0	+\$0
COM	COM	+\$17	+\$18	+\$22	+\$26
Fabric/Vinyl Grade 2	FG2/VG2	+\$17	+\$18	+\$22	+\$26
Fabric/Vinyl Grade 3	FG3/VG3	+\$34	+\$38	+\$45	+\$53
Fabric/Vinyl Grade 4	FG4/VG4	+\$57	+\$63	+\$75	+\$88
Fabric/Vinyl Grade 5	FG5/VG5	+\$85	+\$94	+\$113	+\$132
Fabric/Vinyl Grade 6	FG6/VG6	+\$124	+\$138	+\$165	+\$193
Fabric/Vinyl Grade 7	FG7/VG7	+\$175	+\$194	+\$233	+\$272
Leather Grade 1	LG1	+\$182	+\$186	+\$224	+\$262
COL	COL	+\$238	+\$244	+\$293	+\$343
Leather Grade 2	LG2	+\$238	+\$244	+\$293	+\$343
Leather Grade 3	LG3	+\$329	+\$336	+\$405	+\$474

If different fabrics are selected for the seat and valance add the multiple upholstery upcharge (UMU) as well, even if the two fabrics are the same grade.

Please reference the [Textile Reference Guide](#) for pricing on fabric over grade 7 and leather over grade 3. Additional CAL 133 information can be found on [page 15](#).

6. Packaging

Packaging	Code	Price
Fully Assembled in a Carton	P1	+\$0

SPECIFICATIONS

Model:	CP FS1 Ottoman	CP FS2 SN1 1-Seat Bench
Dimensions		
Seat Width	22"	26"
Seat Depth	22"	24"
Seat Height	18.5"	18.5"
Materials		
COM (Fully Upholstered)	3.2 yd	3.2 yd
COM (Multi-Upholstery)		
Seat Only	1.9 yd	1.9 yd
Valance Only	1.9 yd	1.9 yd
COL (Fully Upholstered)	49 sq ft	49 sq ft
COL (Multi-Upholstery)		
Seat Only	29.4 sq ft	29.4 sq ft
Valance Only	29.4 sq ft	29.4 sq ft
Weight and Capacity		
Weight	28 lb	60 lb
Weight Capacity		
Warranty (Per Seat)	300 lb	300 lb

NOTE: Yardage requirements for COM and COL are for solid and non-directional fabrics. Additional material may be required for larger repeating patterns.

OTTOMAN AND BENCHES

SPECIFICATIONS

Model:	CP FS2 SN2 2-Seat Bench	CP FS2 SN3 3-Seat Bench
Dimensions		
Seat Width	48"	70"
Seat Depth	24"	24"
Seat Height	18.5"	18.5"
Materials		
COM (Fully Upholstered)	3.8 yd	4.4 yd
COM (Multi-Upholstery)		
Seat Only	2.9 yd	2.9 yd
Valance Only	2.9 yd	2.9 yd
COL (Fully Upholstered)	58.8 sq ft	68.6 sq ft
COL (Multi-Upholstery)		
Seat Only	44.1 sq ft	44.1 sq ft
Valance Only	44.1 sq ft	44.1 sq ft
Weight and Capacity		
Weight	91 lb	106 lb
Weight Capacity		
Warranty (Per Seat)	300 lb	300 lb

NOTE: Yardage requirements for COM and COL are for solid and non-directional fabrics. Additional material may be required for larger repeating patterns.



2-Seat Bench With Metal Pole Feet

Envoi

LOUNGE SEATING

Lean back lounge.

To reach the height of comfort, you should start at its roots. A place where everything feels natural and effortless. Get ready to discover what's possible when innovation comes to life because this is the first-ever flexing solution for lounge. It moves you. It moves with you. Envoi is a pure exposition of comfort-meets-motion with unmatched, unencumbered design.



Highback With Wood Base

EFFECTIVE NOVEMBER 4, 2024

Featured Models

MIDBACK WITH METAL BASE :: \$2,132

Midback, 360-degree swivel, charcoal metal base, fully upholstered, grade 1 textile

HIGHBACK WITH METAL BASE :: \$2,506

Highback, 360-degree swivel, polished aluminum metal base, fully upholstered, grade 3 textile



HIGHBACK WITH WOOD BASE :: \$2,883

Highback, 360-degree swivel, wood base, fully upholstered, grade 4 textile

Features

- Designed by Claudio Bellini
- Backrest flexes and moves when you recline
- Petal-like pieces surround with comfort
- Available in midback or highback
- 4-star base available in three wood or metal finishes
- Auto-return cylinder available on metal base only
- 300 lb weight capacity warranty

1. Product

Back Size and Style	Code	Price	
Midback Lounge	ENV BH4	\$2,132	
Highback Lounge	ENV BH5	\$2,273	

2. Base

Cylinder	Code	Price	
360-Degree Swivel	CH5	+ \$0	
Auto-Return, Fixed Height	CH6	+ \$25	

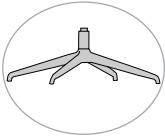
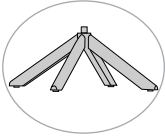
Base Material	Code	Price	
Metal	BMM	+ \$0	
Wood	BMW	+ \$400	

Auto-return cylinder (CH6) is only available with metal base (BMM).

LOUNGE SEATING

2. Base (Cont.)

Base Color	Code	Price	
Metal Color			
Charcoal	BF04	+ \$0	
Bronze	BF05	+ \$0	
Polished Aluminum	BF07	+ \$113	
Wood Cap Stain			
Uptown	BF08	+ \$0	
Colombian	BF09	+ \$0	
Skyline	BF10	+ \$0	

3. Material

Protection	Code	Price	
Fire Retardancy			
CAL 133	UCAL	+\$262	
Cleaning			
Moisture Barrier			
Seat Only	UM2	+\$59	
Back Only	UM1	+\$59	
Seat and Back	UM3	+\$118	
Fully Upholstered			
Midback (For BH4) Textile			
Fabric/Vinyl Grade 1	FG1/VG1	+ \$0	
COM	COM	+ \$42	
Fabric/Vinyl Grade 2	FG2/VG2	+ \$42	
Fabric/Vinyl Grade 3	FG3/VG3	+ \$112	
Fabric/Vinyl Grade 4	FG4/VG4	+ \$196	
Fabric/Vinyl Grade 5	FG5/VG5	+ \$336	
Fabric/Vinyl Grade 6	FG6/VG6	+ \$476	
Fabric/Vinyl Grade 7	FG7/VG7	+ \$616	
Leather Grade1	LG1	+ \$900	
COL	COL	+ \$1,140	
Leather Grade 2	LG2	+ \$1,140	
Leather Grade 3	LG3	+ \$1,440	

LOUNGE SEATING

3. Material (Cont.)

Fully Upholstered	Code	Price
Highback (For BH5) Textile		
Fabric/Vinyl Grade 1	FG1/VG1	+ \$0
COM	COM	+ \$45
Fabric/Vinyl Grade 2	FG2/VG2	+ \$45
Fabric/Vinyl Grade 3	FG3/VG3	+ \$120
Fabric/Vinyl Grade 4	FG4/VG4	+ \$210
Fabric/Vinyl Grade 5	FG5/VG5	+ \$360
Fabric/Vinyl Grade 6	FG6/VG6	+ \$510
Fabric/Vinyl Grade 7	FG7/VG7	+ \$660
Leather Grade 1	LG1	+ \$945
COL	COL	+ \$1,197
Leather Grade 2	LG2	+ \$1,197
Leather Grade 3	LG3	+ \$1,512

3. Material (Cont.)

Multi-Upholstery	Code	Price
Multi-Upholstery Upcharge	UMU	+ \$75
Midback Textile		Seat Only Back and Arms
Fabric/Vinyl Grade 1	FG1/VG1	+ \$0 + \$0
COM	COM	+ \$15 + \$38
Fabric/Vinyl Grade 2	FG2/VG2	+ \$15 + \$38
Fabric/Vinyl Grade 3	FG3/VG3	+ \$40 + \$104
Fabric/Vinyl Grade 4	FG4/VG4	+ \$70 + \$182
Fabric/Vinyl Grade 5	FG5/VG5	+ \$120 + \$312
Fabric/Vinyl Grade 6	FG6/VG6	+ \$170 + \$443
Fabric/Vinyl Grade 7	FG7/VG7	+ \$220 + \$573
Leather Grade 1	LG1	+ \$315 + \$828
COL	COL	+ \$399 + \$1,049
Leather Grade 2	LG2	+ \$399 + \$1,049
Leather Grade 3	LG3	+ \$504 + \$1,326
Highback (For BH5) Textile		Seat Only Back and Arms
Fabric/Vinyl Grade 1	FG1/VG1	+ \$0 + \$0
COM	COM	+ \$15 + \$41
Fabric/Vinyl Grade 2	FG2/VG2	+ \$15 + \$41
Fabric/Vinyl Grade 3	FG3/VG3	+ \$40 + \$109
Fabric/Vinyl Grade 4	FG4/VG4	+ \$70 + \$192
Fabric/Vinyl Grade 5	FG5/VG5	+ \$120 + \$329
Fabric/Vinyl Grade 6	FG6/VG6	+ \$170 + \$467
Fabric/Vinyl Grade 7	FG7/VG7	+ \$220 + \$604
Leather Grade 1	LG1	+ \$315 + \$866
COL	COL	+ \$399 + \$1,097
Leather Grade 2	LG2	+ \$399 + \$1,097
Leather Grade 3	LG3	+ \$504 + \$1,386

If different fabrics are selected for the seat and back/arms, add the multiple upholstery upcharge as well, even if the fabrics are the same grade.

Please reference the [Textile Reference Guide](#) for pricing on fabric over grade 7 and leather over grade 3. Additional CAL 133 information can be found on [page 15](#).

4. Packaging

Packaging	Code	Price
Partially Assembled in Carton	P3	+ \$0
Assembled in Carton	P1	+ \$80



Midback With Metal Base
Featured with SitOnIt Seating's
Huntington — Tropical

EFFECTIVE NOVEMBER 4, 2024 | GSA SIN #: 33721

SPECIFICATIONS

Model:	ENV BH4 Midback Lounge	ENV BH5 Highback Lounge
Dimensions		
Height	34.75"	41.5"
Width	27"	27"
Depth	26"	26"
Seat Depth	18"	18"
Seat Height	16.5"	16.5"
Back Height	21.25"	28"
Materials		
COM (Fully Upholstered)	3 yd	3.25 yd
COM (Multi-Upholstery)		
Back and Arms Only	2.5 yd	2.75 yd
Seat Cushion Only	1 yd	1 yd
COL (Fully Upholstered)	50 sq ft	55 sq ft
COL (Multi-Upholstery)		
Back and Arms Only	40 sq ft	45 sq ft
Seat Cushion Only	15 sq ft	15 sq ft
Weight and Capacity		
Weight	42 lb (BMM) 55.5 lb (BMW)	54 lb (BMM) 67.5 lb (BMW)
Weight Capacity Warranty	300 lb	300 lb

Metal base (BMM). Wood base (BMW).



Highback With Metal Base

Gobi

LOUNGE SEATING

Huddle with inspiration.

Work mode. Wait mode. Let's-get-it-done mode. Today's open and collaborative spaces should help you shift spontaneously. And Gobi is the perfect huddle partner. Its sculpted comfort and modern, easygoing design can carry you through the many modes you find yourself in—so that another day at the office feels like anything but.



*Charcoal Metal Base
Seated with SitOnIt Seating's
Dash – Sky*

EFFECTIVE NOVEMBER 4, 2024

Featured Models

CHARCOAL METAL BASE :: \$1,959

Midback, charcoal metal base, free-swivel fixed-height cylinder, fully upholstered, grade 1 textile

POLISHED ALUMINUM BASE :: \$2,307

Midback, polished aluminum metal base, auto-return fixed-height cylinder, fully upholstered, grade 4 textile

WOOD BASE :: \$2,569

Midback, wood base, free-swivel fixed-height cylinder, fully upholstered, grade 4 textile

Features

- Minimalist design with crisp lines and tailored stitching
- Flared arms allow room for bags, laptops and more
- Soft, sculpted curves provide extra comfort
- Multi-upholstery options on seat cushion
- Bases available in three metal and wood finishes
- Auto-return cylinder available on metal base only
- 300 lb weight capacity warranty

1. Product

Back Size and Style	Code	Price	
Midback Lounge	GBI BH4	\$1,959	

2. Base

Cylinder	Code	Price	
Free Swivel, Fixed Height	CH5	+ \$0	
Auto-Return, Fixed Height	CH6	+ \$25	

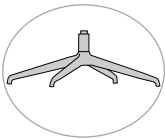
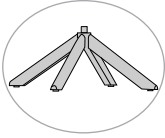
Base Material	Code	Price	
Metal	BMM	+ \$0	
Wood	BMW	+ \$400	

Auto-return cylinder (CH6) is only available with metal base (BMM).

LOUNGE SEATING

2. Base (Cont.)

Base Color	Code	Price	
Metal Color			
Charcoal	BF04	+ \$0	
Bronze	BF05	+ \$0	
Polished Aluminum	BF07	+ \$113	
Wood Cap Stain			
Uptown	BF08	+ \$0	
Colombian	BF09	+ \$0	
Skyline	BF10	+ \$0	
Glides	Code	Price	
Standard Multi-Surface Glides	GL1	+ \$0	

3. Material

Protection	Code	Price	
Fire Retardancy			
CAL 133	UCAL	+\$262	
Cleaning	Code	Price	
Moisture Barrier			
Seat Only	UM2	+\$59	
Back Only	UM1	+\$59	
Seat and Back	UM3	+\$118	
Fully Upholstered	Code	Price	
Fabric/Vinyl Grade 1	FG1/VG1	+ \$0	
COM	COM	+ \$45	
Fabric/Vinyl Grade 2	FG2/VG2	+ \$45	
Fabric/Vinyl Grade 3	FG3/VG3	+ \$120	
Fabric/Vinyl Grade 4	FG4/VG4	+ \$210	
Fabric/Vinyl Grade 5	FG5/VG5	+ \$360	
Fabric/Vinyl Grade 6	FG6/VG6	+ \$510	
Fabric/Vinyl Grade 7	FG7/VG7	+ \$660	
Leather Grade 1	LG1	+ \$1,181	
COL	COL	+ \$1,496	
Leather Grade 2	LG2	+ \$1,496	
Leather Grade 3	LG3	+ \$1,890	

3. Material (Cont.)

Multi-Upholstery	Code	Price
Multi-Upholstery Upcharge	UMU	+ \$75
Seat Shell Textile Only		
Fabric/Vinyl Grade 1	FG1/VG1	+ \$0
COM	COM	+ \$30
Fabric/Vinyl Grade 2	FG2/VG2	+ \$30
Fabric/Vinyl Grade 3	FG3/VG3	+ \$80
Fabric/Vinyl Grade 4	FG4/VG4	+ \$140
Fabric/Vinyl Grade 5	FG5/VG5	+ \$240
Fabric/Vinyl Grade 6	FG6/VG6	+ \$340
Fabric/Vinyl Grade 7	FG7/VG7	+ \$440
Leather Grade 1	LG1	+ \$788
COL	COL	+ \$998
Leather Grade 2	LG2	+ \$998
Leather Grade 3	LG3	+ \$1,260
Multi-Upholstery	Code	Price
Seat Cushion Textile Only		
Fabric/Vinyl Grade 1	FG1/VG1	+ \$0
COM	COM	+ \$15
Fabric/Vinyl Grade 2	FG2/VG2	+ \$15
Fabric/Vinyl Grade 3	FG3/VG3	+ \$40
Fabric/Vinyl Grade 4	FG4/VG4	+ \$70
Fabric/Vinyl Grade 5	FG5/VG5	+ \$120
Fabric/Vinyl Grade 6	FG6/VG6	+ \$170
Fabric/Vinyl Grade 7	FG7/VG7	+ \$220
Leather Grade 1	LG1	+ \$394
COL	COL	+ \$499
Leather Grade 2	LG2	+ \$499
Leather Grade 3	LG3	+ \$630

Textiles approved for Nano and Paseo apply to Gobi. Refer to textile compatibility tool for up-to-date offerings.

If different fabrics are selected for the seat cushion and shell, add the multiple upholstery upcharge as well, even if the fabrics are the same grade.

Please reference the [Textile Reference Guide](#) for pricing on fabric over grade 7 and leather over grade 3. Additional CAL 133 information can be found on [page 15](#).

4. Packaging

Packaging	Code	Price
Partially Assembled in Carton	P3	+ \$0
Assembled in Carton	P1	+ \$80

LOUNGE SEATING

SPECIFICATIONS

Model:	GBI BH4 Midback Lounge
Dimensions	
Height	31.5"
Width	30.25"
Depth	31"
Seat Depth	19"
Seat Height	17.25"
Back Height	21.5"
Materials	
COM (Fully Upholstered)	3.5 yd
COM (Multi-Upholstery) Seat Shell Only Seat Cushion Only	2.8 yd 1 yd
COL (Single Upholstery)	55 sq ft
COL (Multi-Upholstered) Seat Shell Only Seat Cushion Only	48 sq ft 15 sq ft
Weight and Capacity	
Weight	37.5 lb (BMM) 51 lb (BMW)
Weight Capacity Warranty	300 lb

Metal base (BMM). Wood base (BMW).



Wood Base

Kindl

GUEST AND BARIATRIC SEATING

Design and durability — In tandem

Take on the high demands of healthcare with a collection created to make every guest feel good. From clinic lobbies to patient rooms, Kindl delivers an on-trend blend of form and features that answer the call of today's caring spaces.



*Guest Chair
Featured with Momentum's Canter EPU — Ink
and SitOnIt Seating's Galaxy — Indigo*

EFFECTIVE NOVEMBER 4, 2024

Featured Models

21" GUEST CHAIR :: \$1,130

21" seat, glass-filled nylon arm caps, multi-upholstery, grade 2 vinyl seat, grade 2 fabric back

30" BARIATRIC :: \$1,458

30" seat, glass-filled nylon arm caps, multi-upholstery, grade 3 vinyl seat, grade 2 fabric back

42" BARIATRIC :: \$1,822

42" seat, glass-filled nylon arm caps, multi-upholstery, grade 2 vinyl seat, grade 5 vinyl back

Features

- A thoughtful, durable design made for healthcare and high-traffic spaces
- Comprehensive collection of seating options — Guest, Bariatric, Freespan and Tandem
- Linking tables add convenient surfaces and extra space within any start/center/end configuration
- Discreet clean-out, glass-filled nylon arm cap and underside splash guard help create a safer sit
- 100% steel frame provides durability without compromising design
- Adjustable glides ensure a level experience on any surface
- Field-replaceable parts keep Kindl up and running with minimal interruptions
- Wall-saver frame ensures everything's fresh, preventing scuffs and marks
- 500 lb weight capacity for guest models; 600 lb weight capacity warranty for 30" bariatric, 750 lb weight capacity for 42" bariatric, freespan, and preconfigured models
- Meets BIFMA LEVEL, GreenGuard and BIFMA x5.41



30" Bariatric

Featured with Momentum's Silica Suede — Onyx
and Mayer's Patio — Basket

GUEST AND BARIATRIC SEATING

1. Seat

Seat Width	Code	Price	
21" Guest	2080 NH SW21	\$975	
30" Bariatric	2080 NH SW30	\$1,250	
42" Bariatric	2080 NH SW42	\$1,475	

2. Frame

Frame Finish	Code	Price	
Graphite	FCM2	+ \$0	
Silver Metallic	FCM1	+ \$0	

3. Arms

Arm Type	Code	Price	
Open Arm	AT1	+ \$0	
Arm Cap Material	Code	Price	
Glass-Filled Nylon	ACP6	+ \$0	
Arm Cap Finish	Code	Price	
For Glass-Filled Nylon Arm Caps			
Black	RMC3	+ \$0	
Fog	RMC4	+ \$0	

4. Base

Glides	Code	Price
Performance Multi-Surface Adjustable Glides	GL2	+ \$0

5. Cleaning

Splash Guard	Code	Price	
		21"	30"
No Splash Guard	SG0	+ \$0	+ \$0
Splash Guard	SG1	+ \$38	+ \$44

Moisture Barrier	Code	Price	
		21"	30"
No Moisture Barrier	UM0	+ \$0	+ \$0
Moisture Barrier Seat	UM2	+ \$59	+ \$59
Moisture Barrier Back and Seat	UM3	+ \$118	+ \$118

6. Material

Fully Upholstered	Code	Price		
		21"	30"	42"
Seat and Back Textile				
Fabric/Vinyl Grade 1	FG1/VG1	+ \$0	+ \$0	+ \$0
COM	COM	+ \$40	+ \$67	+ \$73
Fabric/Vinyl Grade 2	FG2/VG2	+ \$40	+ \$67	+ \$73
Fabric/Vinyl Grade 3	FG3/VG3	+ \$83	+ \$138	+ \$152
Fabric/Vinyl Grade 4	FG4/VG4	+ \$125	+ \$208	+ \$229
Fabric/Vinyl Grade 5	FG5/VG5	+ \$175	+ \$292	+ \$321
Fabric/Vinyl Grade 6	FG6/VG6	+ \$275	+ \$458	+ \$504
Fabric/Vinyl Grade 7	FG7/VG7	+ \$325	+ \$542	+ \$596
Leather Grade 1	LG1	+ \$390	+ \$645	+ \$705
COL	COL	+ \$494	+ \$817	+ \$893
Leather Grade 2	LG2	+ \$494	+ \$817	+ \$893
Leather Grade 3	LG3	+ \$624	+ \$1,032	\$1,128

GUEST AND BARIATRIC SEATING

6. Material (Cont.)

Multi-Upholstery	Code	Price		
		21"	30"	42"
Multi-Upholstery Upcharge	UMU	+ \$113	+ \$113	+ \$113

Seat Textile Only		Price		
		21"	30"	42"
Fabric/Vinyl Grade 1	FG1/VG1	+ \$0	+ \$0	+ \$0
COM	COM	+ \$18	+ \$27	+ \$36
Fabric/Vinyl Grade 2	FG2/VG2	+ \$18	+ \$27	+ \$36
Fabric/Vinyl Grade 3	FG3/VG3	+ \$37	+ \$55	+ \$75
Fabric/Vinyl Grade 4	FG4/VG4	+ \$56	+ \$83	+ \$113
Fabric/Vinyl Grade 5	FG5/VG5	+ \$79	+ \$117	+ \$158
Fabric/Vinyl Grade 6	FG6/VG6	+ \$124	+ \$183	+ \$248
Fabric/Vinyl Grade 7	FG7/VG7	+ \$146	+ \$217	+ \$293
Leather Grade 1	LG1	+ \$180	+ \$255	+ \$330
COL	COL	+ \$228	+ \$323	+ \$418
Leather Grade 2	LG2	+ \$228	+ \$323	+ \$418
Leather Grade 3	LG3	+ \$288	+ \$408	+ \$528

Multi-Upholstery	Code	Price		
		21"	30"	42"
Back Textile Only				
Fabric/Vinyl Grade 1	FG1/VG1	+ \$0	+ \$0	+ \$0
COM	COM	+ \$24	+ \$40	+ \$45
Fabric/Vinyl Grade 2	FG2/VG2	+ \$24	+ \$40	+ \$45
Fabric/Vinyl Grade 3	FG3/VG3	+ \$50	+ \$83	+ \$94
Fabric/Vinyl Grade 4	FG4/VG4	+ \$75	+ \$125	+ \$142
Fabric/Vinyl Grade 5	FG5/VG5	+ \$105	+ \$175	+ \$198
Fabric/Vinyl Grade 6	FG6/VG6	+ \$165	+ \$275	+ \$312
Fabric/Vinyl Grade 7	FG7/VG7	+ \$195	+ \$325	+ \$368
Leather Grade 1	LG1	+ \$225	+ \$330	+ \$390
COL	COL	+ \$285	+ \$418	+ \$494
Leather Grade 2	LG2	+ \$285	+ \$418	+ \$494
Leather Grade 3	LG3	+ \$360	+ \$528	+ \$624

If different fabrics are selected for the seat and back, add the multi-upholstery upcharge as well, even if the fabrics are the same grade.

Please reference the [Textile Reference Guide](#) for pricing on fabric over grade 7 and leather over grade 3.

7. Packaging

Packaging	Code	Price
Fully Assembled in Carton	P1	+ \$0

EFFECTIVE NOVEMBER 4, 2024 | GSA SIN #: 33721

8. Linking Arm (Stand-Alone Accessory)

Arm Type	Code	Price
----------	------	-------

Linking Arm 2089 AT1 \$103

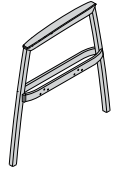

Frame Finish	Code	Price
--------------	------	-------

Graphite FCM2 + \$0

Silver Metallic FCM1 + \$0

Arm Type	Code	Price
----------	------	-------

Open Arm AT1 + \$0

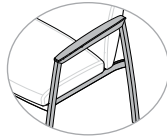

Arm Cap Material	Code	Price
------------------	------	-------

Glass-Filled Nylon ACP6 + \$0

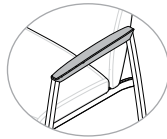

Arm Cap Finish	Code	Price
----------------	------	-------

For Glass-Filled Nylon Arm Caps

Black RMC3 + \$0

Fog RMC4 + \$0



42" Bariatric
 Featured with DesignTex's Wave — Crosswind
 and SitOnIt Seating's Slide — Aqua

SPECIFICATIONS

Model:	2080 NH SW21 21" Guest Chair
Dimensions	
Height	33.94"
Width	24.25"
Depth	25.44"
Arm Height (Height of Arms From Floor)	25.95"
Arm Height (From Seat to Top of Arm)	7.54"
Width Between Arms	20.5"
Seat Width	21.14"
Seat Depth	18.67"
Seat Height	18.39"
Back Height	15.52"
Materials	
COM (Fully Upholstered)	1.75 yd
COM (Multi-Upholstery)	
Seat Only	0.9 yd
Back Only	1.2 yd
COL (Fully Upholstered)	30 sq ft
COL (Multi-Upholstery)	
Seat Only	16 sq ft
Back Only	20 sq ft
Weight and Capacity	
Weight	39.4 lb
Weight Capacity Warranty	500 lb

Yardage requirements for COM and COL are for solid and non-directional fabrics. Additional material may be required for larger repeating patterns.

SPECIFICATIONS

Model:	2080 NH SW30 30" Bariatric	2080 NH SW42 42" Bariatric
Dimensions		
Height	33.94"	33.94"
Width	33.25"	45.25"
Depth	25.44"	25.44"
Arm Height (Height of Arms From Floor)	25.95"	25.95"
Arm Height (From Seat to Top of Arm)	7.54"	7.54"
Width Between Arms	29.5"	41.5"
Seat Width	30.08"	42.08"
Seat Depth	18.67"	18.67"
Seat Height	18.39"	18.39"
Back Height	15.52"	15.52"
Materials		
COM (Fully Upholstered)	3 yd	3.25 yd
COM (Multi-Upholstery)		
Seat Only	1.15 yd	1.6 yd
Back Only	1.9 yd	2 yd
COL (Fully Upholstered)	60 sq ft	65 sq ft
COL (Multi-Upholstery)		
Seat Only	23 sq ft	30 sq ft
Back Only	30 sq ft	35 sq ft
Weight and Capacity		
Weight	47.3 lb	60.7 lb
Weight Capacity Warranty	600 lb	750 lb

Yardage requirements for COM and COL are for solid and non-directional fabrics. Additional material may be required for larger repeating patterns.

Kindl

FREESPAN AND PRECONFIGURED MULTISEATING

Design and durability — In tandem

Take on the high demands of healthcare with a collection created to make every guest feel good. From clinic lobbies to patient rooms, Kindl delivers an on-trend blend of form and features that answer the call of today's caring spaces.



*Pre-configured
Featured with SitOnIt Seating's Element —Antigua
and DesignTex's Ink —Serene*

EFFECTIVE NOVEMBER 4, 2024

Featured Models

FREESPAN :: \$1,864

Freespan, glass-filled nylon arm caps, multi-upholstery, grade 2 vinyl seat, grade 5 vinyl back



PRE-CONFIGURED :: \$2,278

Two-seat, glass-filled nylon arm caps, multi-upholstery, grade 2 vinyl seat, grade 7 fabric back

Features

- A thoughtful, durable design made for healthcare and high-traffic spaces
- Comprehensive collection of seating options — Guest, Bariatric, Freespan and Tandem
- Linking tables add convenient surfaces and extra space within any start/center/end configuration
- Discreet clean-out, glass-filled nylon arm cap and underside splash guard help create a safer sit
- 100% steel frame provides durability without compromising design
- Adjustable glides ensure a level experience on any surface
- Field-replaceable parts keep Kindl up and running with minimal interruptions
- Wall-saver frame ensures everything's fresh, preventing scuffs and marks
- 500 lb weight capacity for guest models; 600 lb weight capacity warranty for 30" bariatric, 750 lb weight capacity for 42" bariatric, freespan, and preconfigured models
- Meets BIFMA LEVEL, GreenGuard and BIFMA x5.41

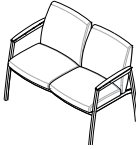
1. Product

Model	Code	Price	
Freespan	2082	\$1,536	
Pre-Configured	2084	\$1,800	

Seat Width	Code	Price	
42"	SW42	+ \$0	

Seat Cushions	Code	Price	
2-Seat	CN2	+ \$0	

FREESPAN AND PRECONFIGURED MULTISEATING

2. Frame

Frame Finish	Code	Price	
Graphite	FCM2	+ \$0	
Silver Metallic	FCM1	+ \$0	

3. Arms

Arm Type	Code	Price	
Open Arm	AT1	+ \$0	

Arm Cap Material	Code	Price	
Glass-Filled Nylon	ACP6	+ \$0	

Arm Cap Finish	Code	Price	
For Glass-Filled Nylon Arm Caps			
Black	RMC3	+ \$0	
Fog	RMC4	+ \$0	

4. Base

Glides	Code	Price	
Performance Multi-Surface Adjustable Glides	GL2	+ \$0	

5. Cleaning

Splash Guard	Code	Price	
No Splash Guard	SG0	+ \$0	
Splash Guard	SG1	+ \$76	

Moisture Barrier	Code	Price	
No Moisture Barrier	UM0	+ \$0	
Moisture Barrier Seat	UM2	+ \$59	
Moisture Barrier Back and Seat	UM3	+ \$118	

6. Material

Fully Upholstered	Code	Price
Fabric/Vinyl Grade 1	FG1/VG1	+ \$0
COM	COM	+ \$73
Fabric/Vinyl Grade 2	FG2/VG2	+ \$73
Fabric/Vinyl Grade 3	FG3/VG3	+ \$152
Fabric/Vinyl Grade 4	FG4/VG4	+ \$229
Fabric/Vinyl Grade 5	FG5/VG5	+ \$321
Fabric/Vinyl Grade 6	FG6/VG6	+ \$504
Fabric/Vinyl Grade 7	FG7/VG7	+ \$596
Leather Grade 1	LG1	+ \$705
COL	COL	+ \$893
Leather Grade 2	LG2	+ \$893
Leather Grade 3	LG3	+ \$1,128
Multi-Upholstery	Code	Price
Multi-Upholstery Upcharge	UMU	+ \$113
Seat Textile Only		
Fabric/Vinyl Grade 1	FG1/VG1	+ \$0
COM	COM	+ \$40
Fabric/Vinyl Grade 2	FG2/VG2	+ \$40
Fabric/Vinyl Grade 3	FG3/VG3	+ \$83
Fabric/Vinyl Grade 4	FG4/VG4	+ \$125
Fabric/Vinyl Grade 5	FG5/VG5	+ \$175
Fabric/Vinyl Grade 6	FG6/VG6	+ \$275
Fabric/Vinyl Grade 7	FG7/VG7	+ \$325
Leather Grade 1	LG1	+ \$330
COL	COL	+ \$418
Leather Grade 2	LG2	+ \$418
Leather Grade 3	LG3	+ \$528

FREESPAN AND PRECONFIGURED MULTISEATING

6. Material (Cont)

Multi-Upholstery	Code	Price
Back Textile Only		
Fabric/Vinyl Grade 1	FG1/VG1	+ \$0
COM	COM	+ \$40
Fabric/Vinyl Grade 2	FG2/VG2	+ \$40
Fabric/Vinyl Grade 3	FG3/VG3	+ \$83
Fabric/Vinyl Grade 4	FG4/VG4	+ \$125
Fabric/Vinyl Grade 5	FG5/VG5	+ \$175
Fabric/Vinyl Grade 6	FG6/VG6	+ \$275
Fabric/Vinyl Grade 7	FG7/VG7	+ \$325
Leather Grade 1	LG1	+ \$390
COL	COL	+ \$494
Leather Grade 2	LG2	+ \$494
Leather Grade 3	LG3	+ \$624

If different fabrics are selected for the seat and back, add the multi-upholstery upcharge as well, even if the fabrics are the same grade.

Please reference the [Textile Reference Guide](#) for pricing on fabric over grade 7 and leather over grade 3.

7. Packaging

Packaging	Code	Price
Fully Assembled in Carton	P1	+ \$0

8. Linking Arm (Stand-Alone Accessory)

Arm Type	Code	Price
Linking Arm	2089 AT1	\$103

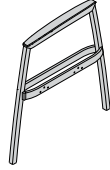

Frame Finish	Code	Price
Graphite	FCM2	+ \$0
Silver Metallic	FCM1	+ \$0

Arm Type	Code	Price
----------	------	-------

Open Arm	AT1	+ \$0
----------	-----	-------

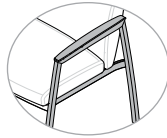

Arm Cap Material	Code	Price
------------------	------	-------

Glass-Filled Nylon	ACP6	+ \$0
--------------------	------	-------

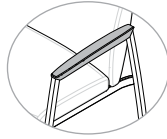

Arm Cap Finish	Code	Price
----------------	------	-------

For Glass-Filled Nylon Arm Caps		
Black	RMC3	+ \$0
Fog	RMC4	+ \$0

PRECONFIGURED MULTISEATING

SPECIFICATIONS

Model:	2082 SW42 Freespan	2084 SW42 Pre-Configured
Dimensions		
Height	33.94"	33.94"
Width	45.25"	46.75"
Depth	25.44"	25.44"
Arm Height (Height of Arms From Floor)	25.95"	25.95"
Arm Height (From Seat to Top of Arm)	7.54"	7.54"
Width Between Arms Per Seat	41.5" N/A	43" 20.5"
Seat Width Per Seat	42.21" N/A	43.5" 21.14"
Seat Depth	18.67"	18.67"
Seat Height	18.39"	18.39"
Back Height	15.52"	15.52"
Materials		
COM (Fully Upholstered)	3.25 yd	3.25 yd
COM (Multi-Upholstery)		
Seat Only	1.75 yd	1.75 yd
Back Only	1.75 yd	1.75 yd
COL (Fully Upholstered)	65 sq ft	65 sq ft
COL (Multi-Upholstery)		
Seat Only	30 sq ft	30 sq ft
Back Only	35 sq ft	35 sq ft
Weight and Capacity		
Weight	63.5 lb	72.7 lb
Weight Capacity Warranty	750 lb	750 lb

Yardage requirements for COM and COL are for solid and non-directional fabrics. Additional material may be required for larger repeating patterns.

Kindl

LINKING TABLES FOR START/CENTER/END

Design and durability — In tandem

Take on the high demands of healthcare with a collection created to make every guest feel good. From clinic lobbies to patient rooms, Kindl delivers an on-trend blend of form and features that answer the call of today's caring spaces.



EFFECTIVE NOVEMBER 4, 2024

Featured Models

LAMINATE CENTER IN-LINE TABLE :: \$550

Glass-filled nylon arm caps, grade 1 laminate

LAMINATE 90° CORNER TABLE :: \$670

Glass-filled nylon arm caps, grade 1 laminate

Features

- Connects Kindl seating (start, center and end)
- Center in-line table is interchangeable with 21" center chairs
- 90° corner table helps expand any configuration
- ¾" tabletop thickness
- Six grade 1 options and 17 grade 2 options

1. Product

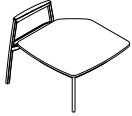
Tables	Code	Price	
Center In-Line Table	2086 TTL1	\$550	
90° Corner Table	2086 TTL4	\$670	

2. Frame

Frame Finish	Code	Price
Graphite	FCM2	+ \$0
Silver Metallic	FCM1	+ \$0

3. Arms

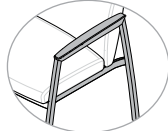
Arm Type	Code	Price	
Open Arm	AT1	+ \$0	

Arm Cap Material	Code	Price	
Glass-Filled Nylon	ACP6	+ \$0	

Arm Cap Finish	Code	Price
For Glass-Filled Nylon Arm Caps		
Black	RMC3	+ \$0
Fog	RMC4	+ \$0

LINKING TABLES FOR START/CENTER/END

4. Base

Glides	Code	Price
Performance Multi-Surface Adjustable Glides	GL2	+ \$0

5. Material

Laminate Grade	Code	Price
Grade 1	GR1	+ \$0
Grade 2	GR2	+ \$137

Laminate Color	Code	Price
Grade 1 Laminates		
White	TL29	+ \$0
Black	TL19	+ \$0
Sandalwood	TL27	+ \$0
Walnut Amati	TL28	+ \$0
Cabinet Maple	TL21	+ \$0
Folkstone Grey	TL24	+ \$0
Grade 2 Laminates		
Neo Walnut	TL50	+ \$0
Grey Elm	TL51	+ \$0
Skyline Walnut	TL15	+ \$0
Kingswood Walnut	TL53	+ \$0
Uptown Walnut	TL14	+ \$0
Colombian Walnut	TL55	+ \$0
Manitoba	TL56	+ \$0
Tuscan Walnut	TL57	+ \$0
Field Elm	TL13	+ \$0
Steel Mesh	TL59	+ \$0
Portico Teak	TL60	+ \$0
Platinum	TL61	+ \$0
Grey Elm	TL51	+ \$0
Frosty White	TL16	+ \$0
Crisp Linen	TL64	+ \$0
Classic Linen	TL17	+ \$0
Designer White	TL66	+ \$0

6. Packaging

Packaging	Code	Price
Knocked Down	P7	+ \$0

EFFECTIVE NOVEMBER 4, 2024 | GSA SIN #: 33721

SPECIFICATIONS

Model:	2086 TTL1 Center In-Line	2086 TTL4 90° Corner
Dimensions		
Height	25.95"	25.95"
Width	23.49"	31.5"
Depth	25.48"	32.98"
Tabletop Thickness	0.75"	0.75"
Table Depth	22.5"	30"
Table Height	15.88"	15.88"
Weight and Capacity		
Weight	29.8 lb	38.5 lb

Yardage requirements for COM and COL are for solid and non-directional fabrics. Additional material may be required for larger repeating patterns.

Kindl

START/CENTER/END MULTISEATING

Design and durability — In tandem

Take on the high demands of healthcare with a collection created to make every guest feel good. From clinic lobbies to patient rooms, Kindl delivers an on-trend blend of form and features that answer the call of today's caring spaces.



EFFECTIVE NOVEMBER 4, 2024

Featured Models

JUST RIGHT :: \$2,482

21" start + 30" bariatric end,
glass-filled nylon arm caps,
multi-upholstery, grade 3 fabrics

TWO AND ONE :: \$2,675

Freespan 2-cushion start + 21" end,
glass-filled nylon arm caps,
single upholstery, grade 4 fabric





WITH TABLE :: \$3,852

30" start + 30" end + in-line table,
glass-filled nylon arm caps,
multi-upholstery, grade 5 seat,
grade 8 back

Features









- A thoughtful, durable design made for healthcare and high-traffic spaces
- Comprehensive collection of seating options — Guest, Bariatric, Freespan and Tandem
- Linking tables add convenient surfaces and extra space within any start/center/end configuration
- Discreet clean-out, glass-filled nylon arm cap and underside splash guard help create a safer sit
- 100% steel frame provides durability without compromising design
- Adjustable glides ensure a level experience on any surface
- Field-replaceable parts keep Kindl up and running with minimal interruptions
- Wall-saver frame ensures everything's fresh, preventing scuffs and marks
- 500 lb weight capacity for guest models; 600 lb weight capacity warranty for 30" bariatric, 750 lb weight capacity for 42" bariatric, freespan, and preconfigured models
- Meets BIFMA LEVEL, GreenGuard and BIFMA x5.41

1. Product

Seat Width	Code	Price	
Start			
Start 21" Guest	2083 FS4 SW21	\$975	
Start 30" Bariatric	2083 FS4 SW30	\$1,250	
Start 42" Bariatric	2083 FS4 SW42 CN1	\$1,475	
Start 42" Freespan	2083 FS4 SW42 CN2	\$1,536	

START/CENTER/END MULTISEATING

1. Product (Cont.)

Seat Width	Code	Price	
Center			
Center 21" Guest	2083 FS5 SW21	\$945	
Center 30" Bariatric	2083 FS5 SW30	\$1,220	
Center 42" Bariatric	2083 FS5 SW42 CN1	\$1,445	
Center 42" Freespan	2083 FS5 SW42 CN2	\$1,506	
End			
End 21" Guest	2083 FS6 SW21	\$945	
End 30" Bariatric	2083 FS6 SW30	\$1,220	
End 42" Freespan	2083 FS6 SW42 CN1	\$1,445	
End 42" Freespan	2083 FS6 SW42 CN2	\$1,506	

EFFECTIVE NOVEMBER 4, 2024 | GSA SIN #: 33721

2. Frame

Frame Finish	Code	Price
Graphite	FCM2	+ \$0
Silver Metallic	FCM1	+ \$0

3. Arms

Arm Type	Code	Price
Open Arm	AT1	+ \$0

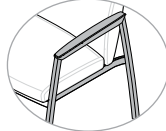

Arm Cap Material	Code	Price
Glass-Filled Nylon	ACP6	+ \$0

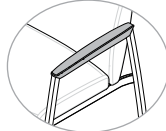

Arm Cap Finish	Code	Price
For Glass-Filled Nylon Arm Caps		
Black	RMC3	+ \$0
Fog	RMC4	+ \$0

4. Base

Glides	Code	Price
Performance Multi-Surface Adjustable Glides	GL2	+ \$0

5. Cleaning

Splash Guard	Code	Price	
		21"	30"
No Splash Guard	SG0	+ \$0	+ \$0
Splash Guard	SG1	+ \$38	+ \$44

Moisture Barrier	Code	Price	
		21"	30"
No Moisture Barrier	UM0	+ \$0	+ \$0
Moisture Barrier Seat	UM2	+ \$59	+ \$59
Moisture Barrier Back and Seat	UM3	+ \$118	+ \$118

6. Material

Fully Upholstered	Code	Price		
		21"	30"	42"
Seat and Back Textile				
Fabric/Vinyl Grade 1	FG1/VG1	+ \$0	+ \$0	+ \$0
COM	COM	+ \$40	+ \$67	+ \$73
Fabric/Vinyl Grade 2	FG2/VG2	+ \$40	+ \$67	+ \$73
Fabric/Vinyl Grade 3	FG3/VG3	+ \$83	+ \$138	+ \$152
Fabric/Vinyl Grade 4	FG4/VG4	+ \$125	+ \$208	+ \$229
Fabric/Vinyl Grade 5	FG5/VG5	+ \$175	+ \$292	+ \$321
Fabric/Vinyl Grade 6	FG6/VG6	+ \$275	+ \$458	+ \$504
Fabric/Vinyl Grade 7	FG7/VG7	+ \$325	+ \$542	+ \$596
Leather Grade 1	LG1	+ \$390	+ \$645	+ \$705
COL	COL	+ \$494	+ \$817	+ \$893
Leather Grade 2	LG2	+ \$494	+ \$817	+ \$893
Leather Grade 3	LG3	+ \$624	+ \$1,032	\$1,128
Multi-Upholstery				
Multi-Upholstery Upcharge	UMU	+ \$113		
Seat Textile Only				
		21"	30"	
Fabric/Vinyl Grade 1	FG1/VG1	+ \$0	+ \$0	
COM	COM	+ \$18	+ \$27	
Fabric/Vinyl Grade 2	FG2/VG2	+ \$18	+ \$27	
Fabric/Vinyl Grade 3	FG3/VG3	+ \$37	+ \$55	
Fabric/Vinyl Grade 4	FG4/VG4	+ \$56	+ \$83	
Fabric/Vinyl Grade 5	FG5/VG5	+ \$79	+ \$117	
Fabric/Vinyl Grade 6	FG6/VG6	+ \$124	+ \$183	
Fabric/Vinyl Grade 7	FG7/VG7	+ \$146	+ \$217	
Leather Grade 1	LG1	+ \$180	+ \$255	
COL	COL	+ \$228	+ \$323	
Leather Grade 2	LG2	+ \$228	+ \$323	
Leather Grade 3	LG3	+ \$288	+ \$408	
Seat Textile Only				
		42" Bariatric	42" Freespan	
Fabric/Vinyl Grade 1	FG1/VG1	+ \$0	+ \$0	
COM	COM	+ \$36	+ \$40	
Fabric/Vinyl Grade 2	FG2/VG2	+ \$36	+ \$40	
Fabric/Vinyl Grade 3	FG3/VG3	+ \$75	+ \$83	
Fabric/Vinyl Grade 4	FG4/VG4	+ \$113	+ \$125	
Fabric/Vinyl Grade 5	FG5/VG5	+ \$158	+ \$175	
Fabric/Vinyl Grade 6	FG6/VG6	+ \$248	+ \$275	
Fabric/Vinyl Grade 7	FG7/VG7	+ \$293	+ \$325	
Leather Grade 1	LG1	+ \$330	+ \$330	
COL	COL	+ \$418	+ \$418	
Leather Grade 2	LG2	+ \$418	+ \$418	
Leather Grade 3	LG3	+ \$528	+ \$528	

Multi-Upholstery	Code	Price	
Back Textile Only		21"	30"
Fabric/Vinyl Grade 1	FG1/VG1	+ \$0	+ \$0
COM	COM	+ \$24	+ \$40
Fabric/Vinyl Grade 2	FG2/VG2	+ \$24	+ \$40
Fabric/Vinyl Grade 3	FG3/VG3	+ \$50	+ \$83
Fabric/Vinyl Grade 4	FG4/VG4	+ \$75	+ \$125
Fabric/Vinyl Grade 5	FG5/VG5	+ \$105	+ \$175
Fabric/Vinyl Grade 6	FG6/VG6	+ \$165	+ \$275
Fabric/Vinyl Grade 7	FG7/VG7	+ \$195	+ \$325
Leather Grade 1	LG1	+ \$225	+ \$330
COL	COL	+ \$285	+ \$418
Leather Grade 2	LG2	+ \$285	+ \$418
Leather Grade 3	LG3	+ \$360	+ \$528
Back Textile Only		42" Bariatric	42" Freespan
Fabric/Vinyl Grade 1	FG1/VG1	+ \$0	+ \$0
COM	COM	+ \$45	+ \$40
Fabric/Vinyl Grade 2	FG2/VG2	+ \$45	+ \$40
Fabric/Vinyl Grade 3	FG3/VG3	+ \$94	+ \$83
Fabric/Vinyl Grade 4	FG4/VG4	+ \$142	+ \$125
Fabric/Vinyl Grade 5	FG5/VG5	+ \$198	+ \$175
Fabric/Vinyl Grade 6	FG6/VG6	+ \$312	+ \$275
Fabric/Vinyl Grade 7	FG7/VG7	+ \$368	+ \$325
Leather Grade 1	LG1	+ \$390	+ \$390
COL	COL	+ \$494	+ \$494
Leather Grade 2	LG2	+ \$494	+ \$494
Leather Grade 3	LG3	+ \$624	+ \$624

If different fabrics are selected for the seat and back, add the multi-upholstery upcharge as well, even if the fabrics are the same grade.

Please reference the [Textile Reference Guide](#) for pricing on fabric over grade 7 and leather over grade 3..

7. Packaging

Packaging	Code	Price
Fully Assembled in Carton	P1	+ \$0
Finally Assembly Required	P3	+ \$0

SPECIFICATIONS

Model: 2083 FS4	SW21 21" Start	SW30 30" Start	SW42 42" Start
Dimensions			
Height	33.94"	33.94"	33.94"
Width	24.25"	33.25"	45.25"
Depth	25.44"	25.44"	25.44"
Arm Height (Height of Arms From Floor)	25.95"	25.95"	25.95"
Arm Height (From Seat to Top of Arm)	7.54"	7.54"	7.54"
Width Between Arms	20.5"	29.5"	41.5"
Seat Width	21.14"	30.08"	42.08"
Seat Depth	18.67"	18.67"	18.67"
Seat Height	18.39"	18.39"	18.39"
Back Height	15.52"	15.52"	15.52"
Materials			
COM (Fully Upholstered)	1.75 yd	3 yd	3.25 yd
COM (Multi-Upholstery)			
Seat Only	0.9 yd	1.15 yd	1.6 yd
Back Only	1.2 yd	1.9 yd	2 yd
COL (Fully Upholstered)	36 sq ft	60 sq ft	65 sq ft
COL (Multi-Upholstery)			
Seat Only	16 sq ft	23 sq ft	30 sq ft
Back Only	20 sq ft	30 sq ft	35 sq ft
Weight and Capacity			
Weight	41.2 lb	49.1 lb	62.5 lb
Weight Capacity Warranty	500 lb	600 lb	750 lb

Yardage requirements for COM and COL are for solid and non-directional fabrics. Additional material may be required for larger repeating patterns.

EFFECTIVE NOVEMBER 4, 2024 | GSA SIN #: 33721

SPECIFICATIONS

Model: 2083 FS5	SW21 21" Center	SW30 30" Center	SW42 42" Center
Dimensions			
Height	33.94"	33.94"	33.94"
Width	22.72"	31.67"	43.8"
Depth	25.44"	25.44"	25.44"
Arm Height (Height of Arms From Floor)	25.95"	25.95"	25.95"
Arm Height (From Seat to Top of Arm)	7.54"	7.54"	7.54"
Seat Width	21.14"	30.08"	42.08"
Seat Depth	18.67"	18.67"	18.67"
Seat Height	18.39"	18.39"	18.39"
Back Height	15.52"	15.52"	15.52"
Materials			
COM (Fully Upholstered)	1.75 yd	3 yd	3.25 yd
COM (Multi-Upholstery)			
Seat Only	0.9 yd	1.15 yd	1.6 yd
Back Only	1.2 yd	1.9 yd	2 yd
COL (Fully Upholstered)	36 sq ft	60 sq ft	65 sq ft
COL (Multi-Upholstery)			
Seat Only	16 sq ft	23 sq ft	30 sq ft
Back Only	20 sq ft	30 sq ft	35 sq ft
Weight and Capacity			
Weight	33.3 lb	41.1 lb	54.5 lb
Weight Capacity Warranty	500 lb	600 lb	750 lb

Yardage requirements for COM and COL are for solid and non-directional fabrics. Additional material may be required for larger repeating patterns.

SPECIFICATIONS

Model: 2083 FS6	SW21 21" End	SW30 30" End	SW42 42" End
Dimensions			
Height	33.94"	33.94"	33.94"
Width	22.72"	31.67"	43.8"
Depth	25.44"	25.44"	25.44"
Arm Height (Height of Arms From Floor)	25.95"	25.95"	25.95"
Arm Height (From Seat to Top of Arm)	7.54"	7.54"	7.54"
Seat Width	21.14"	30.08"	42.08"
Seat Depth	18.67"	18.67"	18.67"
Seat Height	18.39"	18.39"	18.39"
Back Height	15.52"	15.52"	15.52"
Materials			
COM (Fully Upholstered)	1.75 yd	3 yd	3.25 yd
COM (Multi-Upholstery)			
Seat Only	0.9 yd	1.15 yd	1.6 yd
Back Only	1.2 yd	1.9 yd	2 yd
COL (Fully Upholstered)	36 sq ft	60 sq ft	65 sq ft
COL (Multi-Upholstery)			
Seat Only	16 sq ft	23 sq ft	30 sq ft
Back Only	20 sq ft	30 sq ft	35 sq ft
Weight and Capacity			
Weight	31.5 lb	39.4 lb	52.8 lb
Weight Capacity Warranty	500 lb	600 lb	750 lb

Yardage requirements for COM and COL are for solid and non-directional fabrics. Additional material may be required for larger repeating patterns.

Nano

MODULAR LOUNGE TYPICALS

Easy from every angle.

Meet Nano, our uniquely designed and easy-to-spec modular lounge collection. Featuring a triangle, diamond, trapezoid and boomerang, Nano's geometric shapes make on-the-spot configuration easy and fun. Create a new, one-of-a-kind look every time in thousands of combinations.

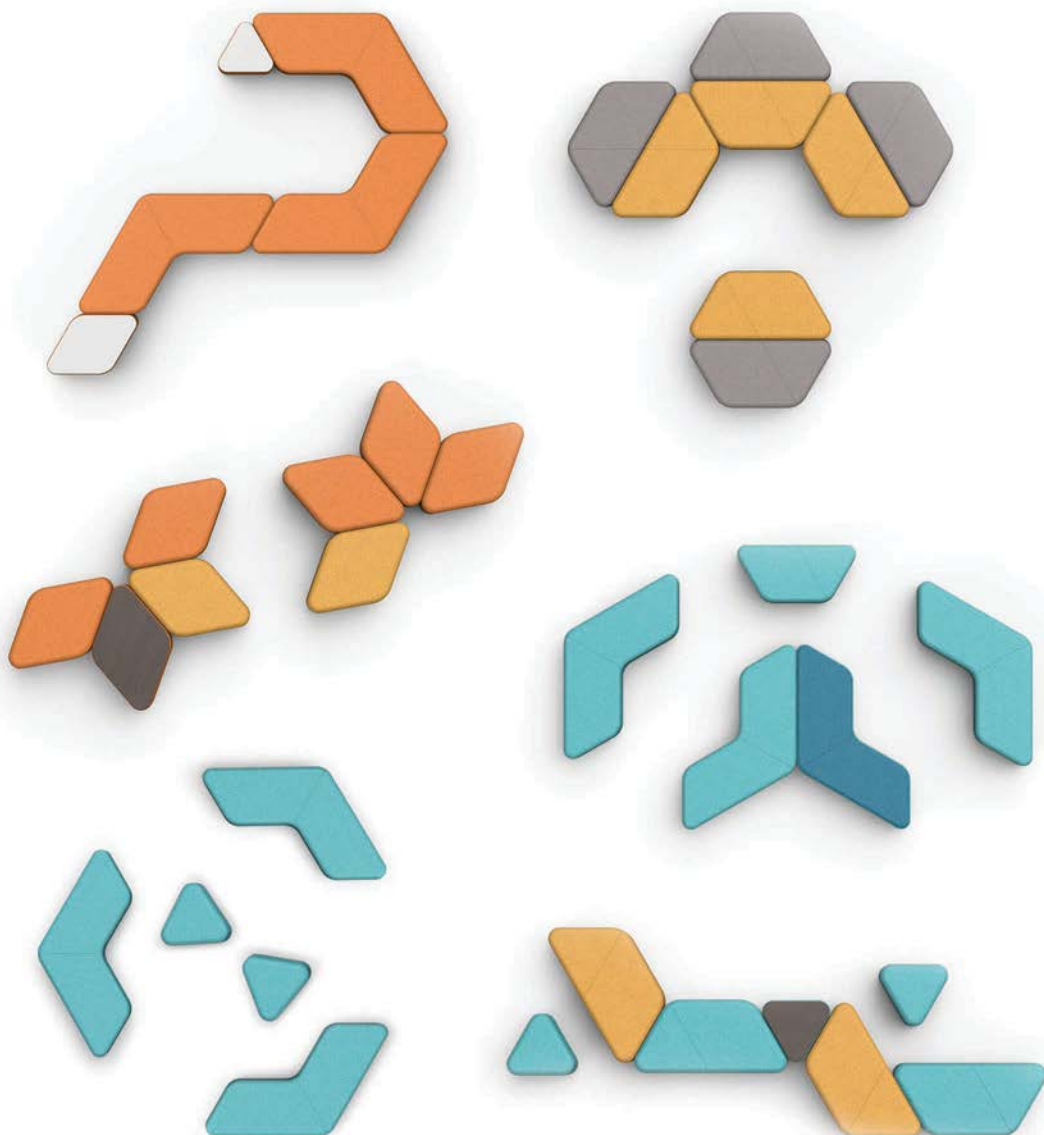

Typical 1

Line	Category	Part Number	Qty	Description	Unit Price	Ext Price		
1	Table	NNO FS14 TM4 TSS2 FG1 LS1	1	Diamond, Solid Surface Tabletop, Fixed Glides, Fully Upholstered, Grade 1 Textile	\$1,734	\$1,734		
2	Seating	NNO FS16 TM0 FG1 LS1	3	Boomerang, Fixed Glides, Fully Upholstered, Grade 1 Textile	\$3,342	\$10,026		
3	Table	NNO FS13 TM4 TSS2 FG1 LS1	1	Triangle, Solid Surface Tabletop, Fixed Glides, Fully Upholstered, Grade 1 Textile	\$1,220	\$1,220		
TOTAL: \$12,980								

Typical 2

Line	Category	Part Number	Qty	Description	Unit Price	Ext Price		
1	Seating	NNO FS16 TM0 FG1 LS1	4	Boomerang, Fixed Glides, Fully Upholstered, Grade 1 Textile	\$3,342	\$13,368		
2	Seating	NNO FS15 TM0 FG1 LS1	1	Trapezoid, Fixed Glides, Fully Upholstered, Grade 1 Textile	\$1,415	\$1,415		
TOTAL: \$14,783								

Typical 3

Line	Category	Part Number	Qty	Description	Unit Price	Ext. Price		
1	Seating	NNO FS13 TM0 FG1 LS1	2	Triangle, Fixed Glides, Fully Upholstered, Grade 1 Textile	\$580	\$1,160		
2	Table	NNO FS13 TM3 TL15 FG1 LS1	1	Triangle, Laminate Tabletop, Fixed Glides, Fully Upholstered, Grade 1 Textile	\$720	\$720		
3	Seating	NNO FS15 TM0 FG1 LS1	4	Trapezoid, Fixed Glides, Fully Upholstered, Grade 1 Textile	\$1,415	\$5,660		
TOTAL: \$7,540								

Typical 4

Line	Category	Part Number	Qty	Description	Unit Price	Ext. Price		
1	Seating	NNO FS14 TM0 FG1 LS1	7	Diamond, Fixed Glides, Fully Upholstered, Grade 1 Textile	\$838	\$5,866		
2	Table	NNO FS14 TM3 TL15 FG1 LS1	1	Diamond, Laminate Tabletop, Fixed Glides, Fully Upholstered, Grade 1 Textile	\$1,034	\$1,034		
TOTAL: \$6,900								

Typical 5

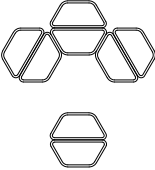
Line	Category	Part Number	Qty	Description	Unit Price	Ext. Price	
1	Seating	NNO FS15 TM0 FG1 LS1	8	Trapezoid, Fixed Glides, Fully Upholstered, Grade 1 Textile	\$1,415	\$11,320	

TOTAL: \$11,320

Typical 6

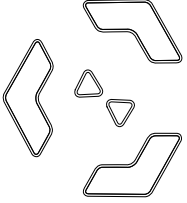
Line	Category	Part Number	Qty	Description	Unit Price	Ext. Price	
1	Seating	NNO FS16 TM0 FG1 LS1	3	Boomerang, Fixed Glides, Fully Upholstered, Grade 1 Textile	\$3,342	\$10,026	
2	Seating	NNO FS13 TM0 FG1 LS1	2	Triangle, Fixed Glides, Fully Upholstered, Grade 1 Textile	\$580	\$1,160	

TOTAL: \$11,186

Typical 7

Line	Category	Part Number	Qty	Description	Unit Price	Ext. Price	
1	Table	NNO FS13 TM3 TL13 FG1 LS1	2	Triangle, Laminate Tabletop, Fixed Glides, Fully Upholstered, Grade 1 Textile	\$720	\$1,440	
2	Seating	NNO FS14 TM0 FG1 LS1	2	Diamond, Fixed Glides, Fully Upholstered, Grade 1 Textile	\$838	\$1,676	
3	Seating	NNO FS15 TM0 FG1 LS1	4	Trapezoid, Fixed Glides, Fully Upholstered, Grade 1 Textile	\$1,415	\$5,660	

TOTAL: \$8,776

Typical 8

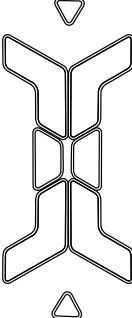
Line	Category	Part Number	Qty	Description	Unit Price	Ext. Price	
1	Seating	NNO FS13 TM0 FG1 LS1	2	Triangle, Fixed Glides, Fully Upholstered, Grade 1 Textile	\$580	\$1,160	
2	Seating	NNO FS16 TM0 FG1 LS1	4	Boomerang, Fixed Glides, Fully Upholstered, Grade 1 Textile	\$3,342	\$13,368	
3	Seating	NNO FS15 TM0 FG1 LS1	2	Trapezoid, Fixed Glides, Fully Upholstered, Grade 1 Textile	\$1,415	\$2,830	

TOTAL: \$17,358

Typical 9

Line	Category	Part Number	Qty	Description	Unit Price	Ext Price	
1	Table	NNO FS13 TM4 TSS2 FG1 LS1	5	Triangle, Solid Surface Tabletop, Fixed Glides, Fully Upholstered, Grade 1 Textile	\$1,220	\$6,100	
2	Seating	NNO FS16 TM0 FG1 LS1	3	Boomerang, Fixed Glides, Fully Upholstered, Grade 1 Textile	\$3,342	\$10,026	
3	Seating	NNO FS15 TM0 FG1 LS1	6	Trapezoid, Fixed Glides, Fully Upholstered, Grade 1 Textile	\$1,415	\$8,490	

TOTAL: \$24,616

Typical 10

Line	Category	Part Number	Qty	Description	Unit Price	Ext Price	
1	Seating	NNO FS15 TM0 FG1 LS1	4	Trapezoid, Fixed Glides, Fully Upholstered, Grade 1 Textile	\$1,415	\$5,660	
2	Table	NNO FS13 TM4 TSS2 FG1 LS1	2	Triangle, Solid Surface Tabletop, Fixed Glides, Fully Upholstered, Grade 1 Textile	\$1,220	\$2,440	
3	Seating	NNO FS14 TM0 FG1 LS1	1	Diamond, Fixed Glides, Fully Upholstered, Grade 1 Textile	\$838	\$838	
4	Table	NNO FS14 TM4 TSS2 FG1 LS1	1	Diamond, Solid Surface Tabletop, Fixed Glides, Fully Upholstered, Grade 1 Textile	\$1,734	\$1,734	

TOTAL: \$10,672

Typical 11

Line	Category	Part Number	Qty	Description	Unit Price	Ext Price	
1	Table	NNO FS13 TM3 TL14 FG1 LS1	2	Triangle, Laminate Tabletop, Fixed Glides, Fully Upholstered, Grade 1 Textile	\$720	\$1,440	
2	Seating	NNO FS15 TM0 FG1 LS1	4	Trapezoid, Fixed Glides, Fully Upholstered, Grade 1 Textile	\$1,415	\$5,660	
3	Seating	NNO FS14 TM0 FG1 LS1	1	Diamond, Fixed Glides, Fully Upholstered, Grade 1 Textile	\$838	\$838	
4	Table	NNO FS14 TM3 TL14 FG1 LS1	1	Diamond, Laminate Tabletop, Fixed Glides, Fully Upholstered, Grade 1 Textile	\$1,034	\$1,034	

TOTAL: \$8,972

EFFECTIVE NOVEMBER 4, 2024 | GSA SIN #: 33721

Typical 12

Line	Category	Part Number	Qty	Description	Unit Price	Ext. Price	
1	Seating	NNO FS15 TM0 FG1 LS1	4	Trapezoid, Fixed Glides, Fully Upholstered, Grade 1 Textile	\$1,415	\$5,660	
2	Table	NNO FS13 TM4 TSS2 FG1 LS1	1	Triangle, Solid Surface Tabletop, Fixed Glides, Fully Upholstered, Grade 1 Textile	\$1,220	\$1,220	
3	Seating	NNO FS14 TM0 FG1 LS1	1	Diamond, Fixed Glides, Fully Upholstered, Grade 1 Textile	\$838	\$838	
4	Table	NNO FS14 TM4 TSS2 FG1 LS1	1	Diamond, Solid Surface Tabletop, Fixed Glides, Fully Upholstered, Grade 1 Textile	\$1,734	\$1,734	
5	Seating	NNO FS13 TM0 FG1 LS1	1	Triangle, Fixed Glides, Fully Upholstered, Grade 1 Textile	\$580	\$580	

TOTAL: \$10,032

Typical 13

Line	Category	Part Number	Qty	Description	Unit Price	Ext. Price	
1	Seating	NNO FS16 TM0 FG1 LS1	2	Boomerang, Fixed Glides, Fully Upholstered, Grade 1 Textile	\$3,342	\$6,684	
2	Seating	NNO FS15 TM0 FG1 LS1	2	Trapezoid, Fixed Glides, Fully Upholstered, Grade 1 Textile	\$1,415	\$2,830	

TOTAL: \$9,514

Typical 14

Line	Category	Part Number	Qty	Description	Unit Price	Ext. Price	
1	Seating	NNO FS15 TM0 FG1 LS1	4	Trapezoid, Fixed Glides, Fully Upholstered, Grade 1 Textile	\$1,415	\$5,660	
2	Seating	NNO FS14 TM0 FG1 LS1	1	Diamond, Fixed Glides, Fully Upholstered, Grade 1 Textile	\$838	\$838	
3	Table	NNO FS14 TM3 TL13 FG1 LS1	1	Diamond, Laminate Tabletop, Fixed Glides, Fully Upholstered, Grade 1 Textile	\$1,034	\$1,034	
4	Table	NNO FS13 TM3 TL13 FG1 LS1	1	Triangle, Laminate Tabletop, Fixed Glides, Fully Upholstered, Grade 1 Textile	\$720	\$720	
5	Seating	NNO FS13 TM0 FG1 LS1	1	Triangle, Fixed Glides, Fully Upholstered, Grade 1 Textile	\$580	\$580	

TOTAL: \$8,832

EFFECTIVE NOVEMBER 4, 2024 | GSA SIN #: 33721

Typical 15

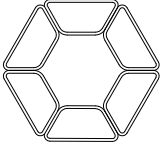
Line	Category	Part Number	Qty	Description	Unit Price	Ext. Price	
1	Seating	NNO FS15 TM0 FG1 LS1	6	Trapezoid, Fixed Glides, Fully Upholstered, Grade 1 Textile	\$1,415	\$8,490	
						TOTAL: \$8,490	

Typical 16

Line	Category	Part Number	Qty	Description	Unit Price	Ext. Price	
1	Seating	NNO FS15 TM0 FG1 LS1	4	Trapezoid, Fixed Glides, Fully Upholstered, Grade 1 Textile	\$1,415	\$5,660	
2	Seating	NNO FS14 TM0 FG1 LS1	1	Diamond, Fixed Glides, Fully Upholstered, Grade 1 Textile	\$838	\$838	
3	Table	NNO FS14 TM3 TL15 FG1 LS1	1	Diamond, Laminate Tabletop, Fixed Glides, Fully Upholstered, Grade 1 Textile	\$1,034	\$1,034	
4	Seating	NNO FS13 TM0 FG1 LS1	2	Trangle, Fixed Glides, Fully Upholstered, Grade 1 Textile	\$580	\$1,160	
						TOTAL: \$8,692	

Nano

MODULAR LOUNGE

Easy from every angle.

Meet Nano, our uniquely designed and easy-to-spec modular lounge collection. Featuring a triangle, diamond, trapezoid and boomerang, Nano's geometric shapes make on-the-spot configuration easy and fun. Create a new, one-of-a-kind look every time in thousands of combinations.



Boomerang

EFFECTIVE NOVEMBER 4, 2024

Featured Models

TRIANGLE TABLE :: \$777

Triangle with laminate tabletop, grade 3 textiles

TRAPEZOID :: \$1,632

Trapezoid, multi-upholstery, grade 3 textiles

BOOMERANG :: \$3,637

Boomerang, multi-upholstery, grade 2 chassis, grade 4 seat

Features

- Four shapes for endless configuration possibilities
- Effortless and fun to design
- Reconfigurable on-the-spot to adapt to any space
- Triangle and diamond shapes feature two solid surface and five laminate tabletop options to enhance functionality
- Mobile and easy to move, or make permanent with ganging brackets
- 400 lb weight capacity warranty (per seat position)



Triangle Table



Trapezoid

MODULAR LOUNGE

1. Product

Model	Code	Price	
Triangle	NNO FS13	\$580	
Diamond	NNO FS14	\$838	
Trapezoid	NNO FS15	\$1,415	
Boomerang	NNO FS16	\$3,342	

2. Tabletop

Tabletop Material	Code	Price	
		Triangle	Diamond
No Tabletop	TM0	+ \$0	+ \$0
Laminate	TM3	+ \$140	+ \$196
Solid Surface	TM4	+ \$640	+ \$896
Tabletop Finish		Price	
Laminate Finish			
Field Elm	TL13	+ \$0	
Uptown Walnut	TL14	+ \$0	
Skyline Walnut	TL15	+ \$0	
Frosty White	TL16	+ \$0	
Classic Linen	TL17	+ \$0	
Solid Surface Color			
Designer White	TSS2	+ \$0	
Cameo White	TSS1	+ \$0	

Tabletops available on triangle and diamond models only.

3. Material

Protection		Price					
Code	Triangle	Triangle Table	Diamond	Diamond Table	Trapezoid	Boomerang	
Fire Retardancy							
CAL 133	UCAL	+\$88	+\$88	+\$175	+\$175	+\$262	+\$494
Cleaning		Price					
Code	Triangle	Triangle Table	Diamond	Diamond Table	Trapezoid	Boomerang	
Moisture Barrier							
Seat	UM2	+\$35	N/A	+\$59	N/A	+\$118	+\$177
Fully Upholstered		Price					
Code	Triangle	Triangle Table	Diamond	Diamond Table	Trapezoid	Boomerang	
Seat and Chassis							
Fabric/Vinyl Grade 1	FG1/VG1	+\$0	+\$0	+\$0	+\$0	+\$0	+\$0
COM	COM	+\$40	+\$36	+\$61	+\$40	+\$77	+\$135
Fabric/Vinyl Grade 2	FG2/VG2	+\$40	+\$36	+\$61	+\$40	+\$77	+\$135
Fabric/Vinyl Grade 3	FG3/VG3	+\$63	+\$57	+\$94	+\$63	+\$120	+\$210
Fabric/Vinyl Grade 4	FG4/VG4	+\$90	+\$81	+\$135	+\$90	+\$171	+\$300
Fabric/Vinyl Grade 5	FG5/VG5	+\$135	+\$121	+\$202	+\$135	+\$256	+\$450
Fabric/Vinyl Grade 6	FG6/VG6	+\$180	+\$162	+\$270	+\$180	+\$342	+\$600
Fabric/Vinyl Grade 7	FG7/VG7	+\$225	+\$202	+\$337	+\$225	+\$427	+\$750
Multi-Upholstery		Price					
Code	Triangle	Triangle Table	Diamond	Diamond Table	Trapezoid	Boomerang	
Multi-Upholstery Upcharge							
UMU		+\$75	N/A	+\$75	N/A	+\$75	+\$75
Seat Only		Price					
Code	Triangle	Triangle Table	Diamond	Diamond Table	Trapezoid	Boomerang	
Fabric/Vinyl Grade 1							
FG1/VG1		N/A	+\$0	N/A	+\$0	+\$0	
COM	COM	+\$19	N/A	+\$34	N/A	+\$31	+\$61
Fabric/Vinyl Grade 2							
FG2/VG2		N/A	+\$34	N/A	+\$31	+\$61	
Fabric/Vinyl Grade 3							
FG3/VG3		N/A	+\$52	N/A	+\$48	+\$94	
Fabric/Vinyl Grade 4							
FG4/VG4		N/A	+\$75	N/A	+\$69	+\$135	
Fabric/Vinyl Grade 5							
FG5/VG5		N/A	+\$112	N/A	+\$103	+\$202	
Fabric/Vinyl Grade 6							
FG6/VG6		N/A	+\$150	N/A	+\$138	+\$270	
Fabric/Vinyl Grade 7							
FG7/VG7		N/A	+\$187	N/A	+\$172	+\$337	
Chassis Only		Price					
Code	Triangle	Triangle Table	Diamond	Diamond Table	Trapezoid	Boomerang	
Fabric/Vinyl Grade 1							
FG1/VG1		N/A	+\$0	N/A	+\$0	+\$0	
COM	COM	+\$36	N/A	+\$40	N/A	+\$61	+\$85
Fabric/Vinyl Grade 2							
FG2/VG2		N/A	+\$40	N/A	+\$61	+\$85	
Fabric/Vinyl Grade 3							
FG3/VG3		N/A	+\$63	N/A	+\$94	+\$132	
Fabric/Vinyl Grade 4							
FG4/VG4		N/A	+\$90	N/A	+\$135	+\$189	
Fabric/Vinyl Grade 5							
FG5/VG5		N/A	+\$135	N/A	+\$202	+\$283	
Fabric/Vinyl Grade 6							
FG6/VG6		N/A	+\$180	N/A	+\$270	+\$378	
Fabric/Vinyl Grade 7							
FG6/VG7		N/A	+\$225	N/A	+\$337	+\$472	

Moisture barrier (UM2) seat is not available with tabletop (TM3/TM4). If different fabrics are selected for the seat and chassis, add the multiple upholstery upcharge as well. Please reference the [Textile Reference Guide](#) for pricing on fabric over grade 7 and leather over grade 3. Additional CAL 133 information can be found on [page 15](#).

EFFECTIVE NOVEMBER 4, 2024 | GSA SIN #: 33721

4. Glides

Glide Options	Code	Price
Fixed Glides	LS1	+ \$0

5. Options

Accessories	Code	Price
One Ganging Bracket (Attaches to Either Side)	XGV	+ \$52

Trapezoid and boomerang accommodate up to two ganging units on the 52" sides.

6. Packaging

Packaging	Code	Price
Fully Assembled in a Carton	P1	+ \$0

SPECIFICATIONS

Model:	NNO FS13 Triangle	NNO FS14 Diamond	NNO FS15 Trapezoid	NNO FS16 Boomerang
Dimensions				
Height (TM0)	17"	17"	17"	17"
Height (TM3/TM4)	17"	17"	—	—
Width	23"	37.5"	52"	81"
Depth	21"	25"	25"	50"
Weight	21 lb	32 lb	45 lb	92 lb
Materials				
COM (Fully Upholstered)	2 yd	3 yd	3.5 yd	6.5 yd
COM (Multi-Upholstery)				
Seat Only	1 yd	1.5 yd	1.5 yd	3 yd
Chassis Only	2 yd	2 yd	3 yd	4 yd
Weight and Capacity				
Weight (TM3)	31.5 lb	54.5 lb	—	—
Weight (TM4)	30 lb	51.1 lb	—	—
Weight Capacity Warranty	400 lb	400 lb	800 lb	1200 lb

No tabletop (TM0). Solid surface tabletop (TM4). Laminate tabletop (TM3).

Yardage requirements for COM are for solid and non-directional fabrics. Additional material may be required for larger repeating patterns.

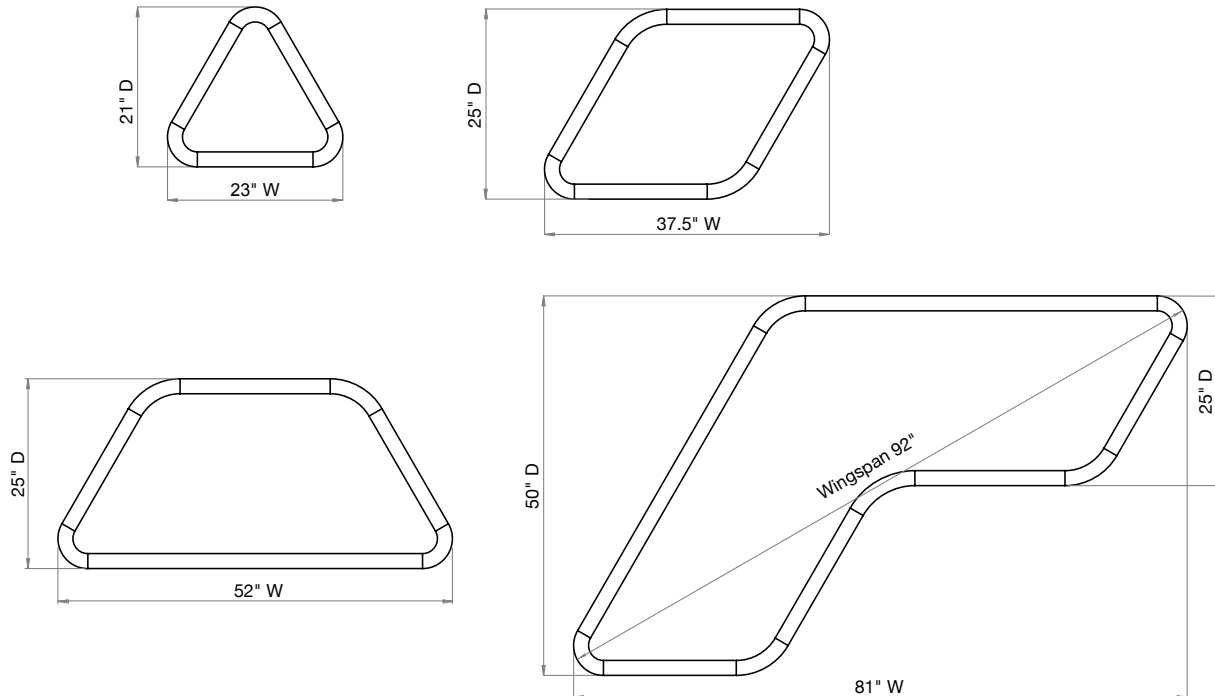

Paséa

MODULAR LOUNGE TYPICALS

Lounge that works.

Paséa features tapered angles and comfort scaling for a lightweight, refined style while promoting an active working posture so that you get our award-winning task chair performance away from your desk.

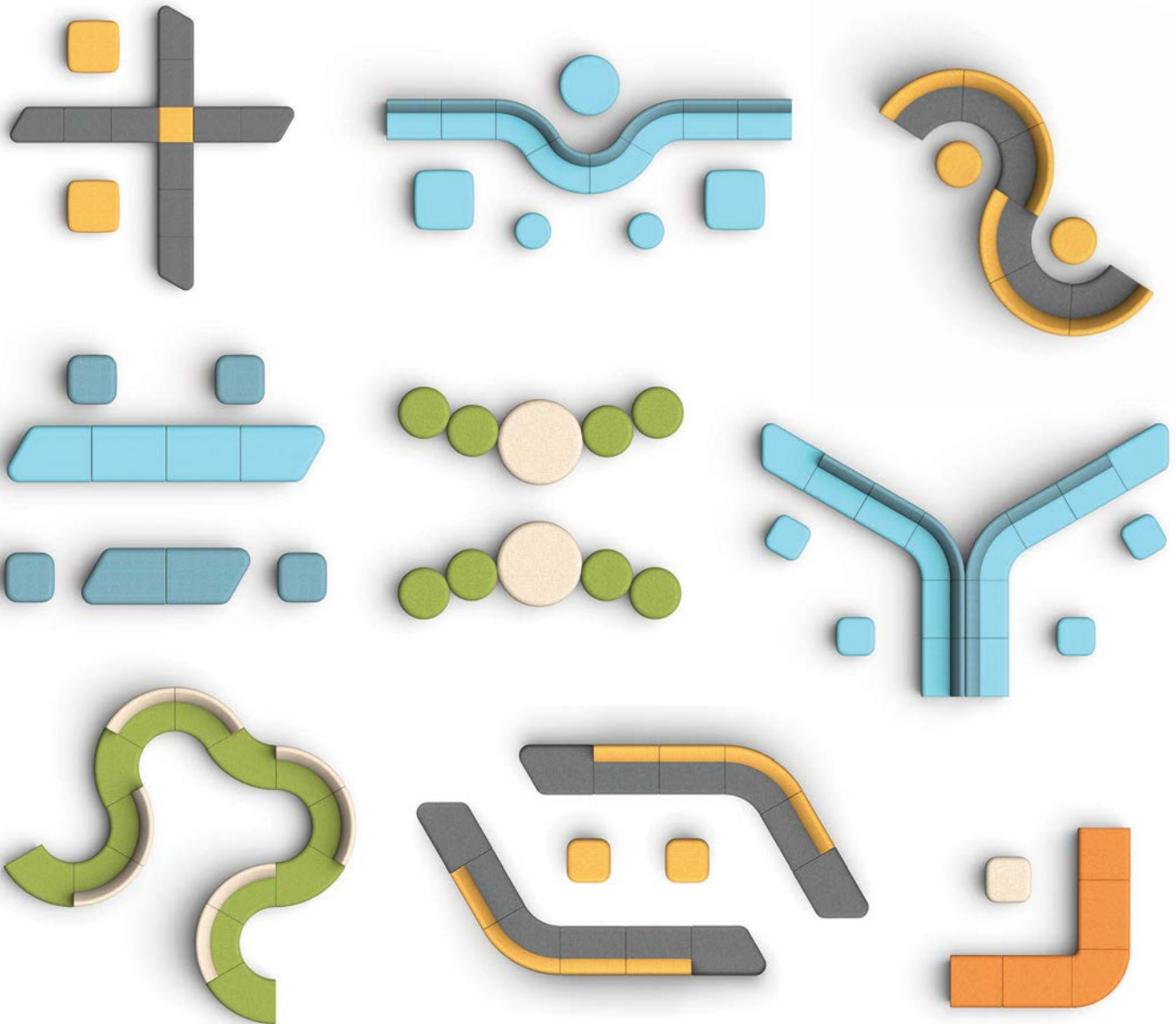

EFFECTIVE NOVEMBER 4, 2024 | GSA SIN #: 33721

Typical 1

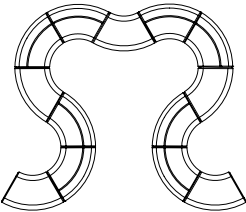
Line	Category	Part Number	Qty	Description	Unit Price	Ext Price	
1	Seating	PAS FS17 SS3	8	120-Degree Inner Seat, Fully Upholstered, Grade 1 Textile	\$3,164	\$25,312	
2	Seating	PAS FS2 BNS6	5	120° Bench, Fully Upholstered, Grade 1 Textile	\$2,373	\$11,865	

TOTAL: \$37,177

Typical 2

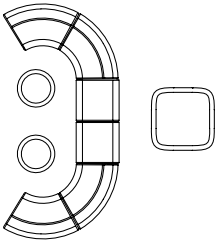
Line	Category	Part Number	Qty	Description	Unit Price	Ext Price	
1	Seating	PAS FS17 SS3	4	120-Degree Inner Seat, Fully Upholstered, Grade 1 Textile	\$3,164	\$12,656	
2	Seating	PAS FS2 BNS1	2	Single Bench, Fully Upholstered, Grade 1 Textile	\$1,320	\$2,640	
3	Seating	PAS FS1 OS1	2	Mini Round Ottoman, Fully Upholstered, Grade 1 Textile	\$793	\$1,586	
4	Seating	PAS FS1 OS4	1	Large Square Ottoman, Fully Upholstered, Grade 1 Textile	\$1,517	\$1,517	

TOTAL: \$18,399

Typical 3

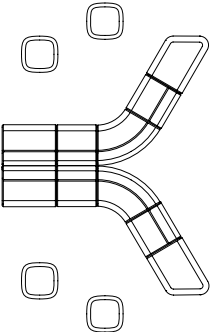
Line	Category	Part Number	Qty	Description	Unit Price	Ext Price	
1	Seating	PAS FS17 SS2	2	1.5 Seat, Fully Upholstered, Grade 1 Textile	\$2,109	\$4,218	
2	Seating	PAS FS17 SS1	4	Single Seat, Fully Upholstered, Grade 1 Textile	\$1,715	\$6,860	
3	Seating	PAS FS17 SS3	2	120° Inner Seat, Fully Upholstered, Grade 1 Textile	\$3,164	\$6,328	
4	Seating	PAS FS2 BNS3	1	Right-Angled End Bench, Fully Upholstered, Grade 1 Textile	\$1,638	\$1,638	
5	Seating	PAS FS2 BNS4	1	Left-Angled End Bench, Fully Upholstered, Grade 1 Textile	\$1,638	\$1,638	
6	Seating	PAS FS1 OS3	4	Mini Square Ottoman, Fully Upholstered, Grade 1 Textile	\$793	\$3,172	

TOTAL: \$23,854

Typical 4

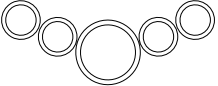
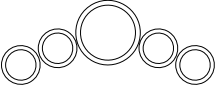
Line	Category	Part Number	Qty	Description	Unit Price	Ext Price	
1	Seating	PAS FS1 OS1	8	Mini Round Ottoman, Fully Upholstered, Grade 1 Textile	\$793	\$6,344	
2	Seating	PAS FS1 OS2	2	Large Round Ottoman, Fully Upholstered, Grade 1 Textile	\$1,517	\$3,034	

TOTAL: \$9,378

EFFECTIVE NOVEMBER 4, 2024 | GSA SIN #: 33721

Typical 5

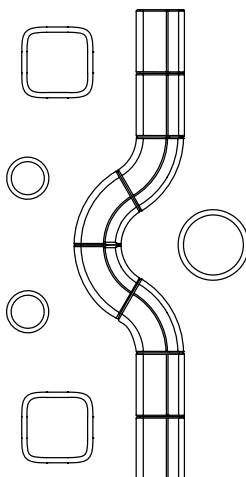
Line	Category	Part Number	Qty	Description	Unit Price	Ext Price	
1	Seating	PAS FS1 OS1	2	Mini Round Ottoman, Fully Upholstered, Grade 1 Textile	\$793	\$1,586	
2	Seating	PAS FS1 OS4	2	Large Square Ottoman, Fully Upholstered, Grade 1 Textile	\$1,517	\$3,034	
3	Seating	PAS FS17 SS4	2	120-Degree Outer Seat, Fully Upholstered, Grade 1 Textile	\$3,164	\$6,328	
4	Seating	PAS FS17 SS3	2	120-Degree Inner Seat, Fully Upholstered, Grade 1 Textile	\$3,164	\$6,328	
5	Seating	PAS FS17 SS2	4	1.5 Seat, Fully Upholstered, Grade 1 Textile	\$2,109	\$8,436	
6	Seating	PAS FS1 OS2	1	Large Round Ottoman, Fully Upholstered, Grade 1 Textile	\$1,517	\$1,517	

TOTAL: \$27,229

Typical 6

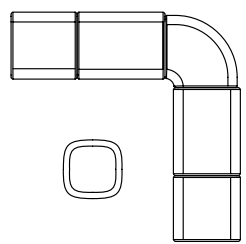
Line	Category	Part Number	Qty	Description	Unit Price	Ext Price	
1	Seating	PAS FS2 BNS1	2	Single Bench, Fully Upholstered, Grade 1 Textile	\$1,320	\$2,640	
2	Seating	PAS FS2 BNS2	2	1.5 Bench, Fully Upholstered, Grade 1 Textile	\$1,715	\$3,430	
3	Seating	PAS FS2 BNS5	1	90-Degree Corner Bench, Fully Upholstered, Grade 1 Textile	\$2,373	\$2,373	
4	Seating	PAS FS1 OS3	1	Mini Square Ottoman, Fully Upholstered, Grade 1 Textile	\$793	\$793	

TOTAL: \$9,236

Typical 7

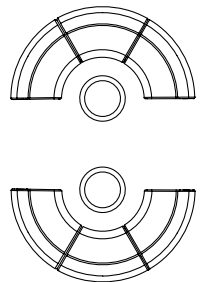
Line	Category	Part Number	Qty	Description	Unit Price	Ext Price	
1	Seating	PAS FS17 SS3	6	120-Degree Inner Seat, Fully Upholstered, Grade 1 Textile	\$3,164	\$18,984	
2	Seating	PAS FS1 OS1	2	Mini Round Ottoman, Fully Upholstered, Grade 1 Textile	\$793	\$1,586	

TOTAL: \$20,570

EFFECTIVE NOVEMBER 4, 2024 | GSA SIN #: 33721

Typical 8

Line	Category	Part Number	Qty	Description	Unit Price	Ext Price	
1	Seating	PAS FS2 BNS2	4	1.5 Bench, Fully Upholstered, Grade 1 Textile	\$1,715	\$6,860	
2	Seating	PAS FS17 SS3	6	120-Degree Inner Seat, Fully Upholstered, Grade 1 Textile	\$3,164	\$18,984	
3	Seating	PAS FS1 OS1	2	Mini Round Ottoman, Fully Upholstered, Grade 1 Textile	\$793	\$1,586	

TOTAL: \$27,430

Typical 9

Line	Category	Part Number	Qty	Description	Unit Price	Ext Price	
1	Seating	PAS FS17 SS3	4	120-Degree Inner Seat, Fully Upholstered, Grade 1 Textile	\$3,164	\$12,656	
2	Seating	PAS FS2 BNS6	2	120-Degree Bench, Fully Upholstered, Grade 1 Textile	\$2,373	\$4,746	
3	Seating	PAS FS1 OS1	2	Mini Round Ottoman, Fully Upholstered, Grade 1 Textile	\$793	\$1,586	

TOTAL: \$18,988

Typical 10

Line	Category	Part Number	Qty	Description	Unit Price	Ext Price	
1	Seating	PAS FS17 SS2	8	1.5 Seat, Fully Upholstered, Grade 1 Textile	\$2,109	\$16,872	
2	Seating	PAS FS2 BNS5	2	90-Degree Corner Bench, Fully Upholstered, Grade 1 Textile	\$2,373	\$4,746	
3	Seating	PAS FS1 OS4	2	Large Square Ottoman, Fully Upholstered, Grade 1 Textile	\$1,517	\$3,034	

TOTAL: \$24,652

EFFECTIVE NOVEMBER 4, 2024 | GSA SIN #: 33721

Typical 11

Line	Category	Part Number	Qty	Description	Unit Price	Ext. Price	
1	Seating	PAS FS1 OS1	3	Mini Round Ottoman, Fully Upholstered, Grade 1 Textile	\$793	\$2,379	
2	Seating	PAS FS2 BNS6	5	120-Degree Bench, Fully Upholstered, Grade 1 Textile	\$2,373	\$11,865	
3	Seating	PAS FS1 OS3	2	Mini Square Ottoman, Fully Upholstered, Grade 1 Textile	\$793	\$1,586	

TOTAL: \$15,830

Typical 12

Line	Category	Part Number	Qty	Description	Unit Price	Ext. Price	
1	Seating	PAS FS1 OS3	4	Mini Square Ottoman, Fully Upholstered, Grade 1 Textile	\$793	\$3,172	
2	Seating	PAS FS2 BNS4	4	Left-Angled End Bench, Fully Upholstered, Grade 1 Textile	\$1,638	\$6,552	
3	Seating	PAS FS2 BNS2	2	1.5 Bench, Fully Upholstered, Grade 1 Textile	\$1,715	\$3,430	

TOTAL: \$13,154

Typical 13

Line	Category	Part Number	Qty	Description	Unit Price	Ext. Price	
1	Seating	PAS FS1 OS1	3	Mini Round Ottoman, Fully Upholstered, Grade 1 Textile	\$793	\$2,379	
2	Seating	PAS FS17 SS4	3	120-Degree Outer Seat, Fully Upholstered, Grade 1 Textile	\$3,164	\$9,492	

TOTAL: \$11,871

Paséa

MODULAR LOUNGE SEATING

Lounge that works.

Work, wait, welcome or wind down, experience the freedom to do anything in a single solution. The tapered base, comfort-scaled seat and built-in backrest with lumbar curve promote an active working posture and lasting support. Rethink what a lounge collection can (and should) be with Paséa.



Single Seat
Featured with SitOnIt Seating's Burst — Papaya
and SitOnIt Seating's Burst — Cornerstone

EFFECTIVE NOVEMBER 4, 2024

Featured Models

SINGLE BENCH :: \$1,387

Single seat bench, fully upholstered, grade 3 seat textile

SINGLE SEAT :: \$1,909

Single seat, multi-upholstery, grade 3 seat and back textile

120° SEAT :: \$3,491

120° inner seat, multi-upholstery, grade 4 seat and back textile

MODULAR LOUNGE SEATING

Features



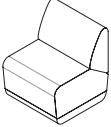
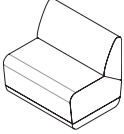
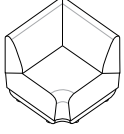
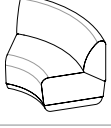
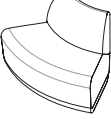

- Choose from a wide variety of benches and seats
- Build using right- or left-angled, 90- or 120-degree pieces
- Configure rectilinear and curvilinear setups with modular seats and benches
- Promote an active working posture with built-in lumbar curve and comfort-scaled seat
- Blend with any environment using graphite or slate base colors

- Add brilliant diamond-cut details with multi-upholstery
- Provide extra convenience with power options
- Adjustable glides standard on modular lounge models
- 400 lb weight capacity warranty (per seat)

1. Product

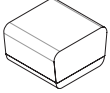
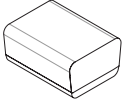
Model	Code	Price	
Seat			
Single Seat	PAS FS17 SS1	\$1,715	
1.5 Seat	PAS FS17 SS2	\$2,109	
90-Degree Corner Seat	PAS FS17 SS5	\$2,611	
120-Degree Inner Seat	PAS FS17 SS3	\$3,164	
120-Degree Outer Seat	PAS FS17 SS4	\$3,164	



1. Product (Cont.)

Model	Code	Price	
Bench			
Single Bench	PAS FS2 BNS1	\$1,320	
1.5 Bench	PAS FS2 BNS2	\$1,715	
Right-Angled End Bench	PAS FS2 BNS3	\$1,638	
Left-Angled End Bench	PAS FS2 BNS4	\$1,638	
90-Degree Corner Bench	PAS FS2 BNS5	\$2,373	
120-Degree Bench	PAS FS2 BNS6	\$2,373	

2. Base

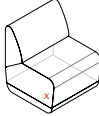
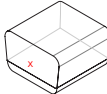
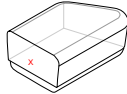
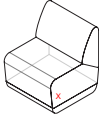
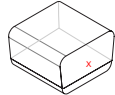
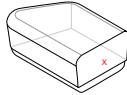
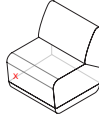
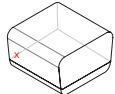

Base Finish	Code	Price
Graphite	LBC2	+ \$0
Slate	LBC3	+ \$0

3. Power

Power Location	Code	Price	
Right-Hand, Side of Unit			
AC/110V	PSR	+ \$125	
Dual USB	PSR	+ \$175	
AC/110V and Dual USB	PSR	+ \$300	
Left-Hand, Side of Unit			
AC/110V	PSL	+ \$125	
Dual USB	PSL	+ \$175	
AC/110V and Dual USB	PSL	+ \$300	
Right-Hand, Front of Unit			
AC/110V	PFR	+ \$125	
Dual USB	PFR	+ \$175	
AC/110V and Dual USB	PFR	+ \$300	



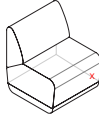
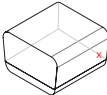
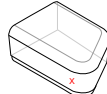
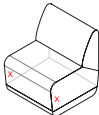
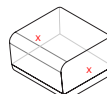

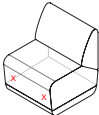
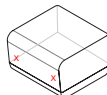
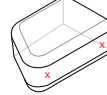
MODULAR LOUNGE SEATING

3. Power (Cont.)



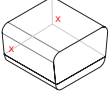
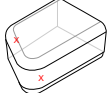
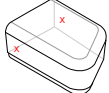
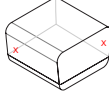

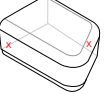
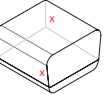
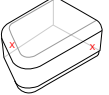
Power Location	Code	Price	
Left-Hand, Front of Unit			
AC/110V	PFL	+ \$125	
Dual USB	PFL	+ \$175	
AC/110V and Dual USB	PFL	+ \$300	
Both Hands, Side of Unit			
AC/110V	PSB	+ \$250	
Dual USB	PSB	+ \$350	
AC/110V and Dual USB	PSB	+ \$600	
Both Hands, Front of Unit			
AC/110V	PFB	+ \$250	
Dual USB	PFB	+ \$350	
AC/110V and Dual USB	PFB	+ \$600	

MODULAR LOUNGE SEATING

3. Power (Cont.)

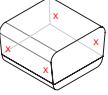
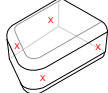
Power Location	Code	Price	
One-Hand, 1 Front and 1 Back			
AC/110V	PBRL	+ \$250	
Dual USB	PBRL	+ \$350	
AC/110V and Dual USB	PBRL	+ \$600	
Both Hands (Right), 1 Front and 1 Back			
AC/110V	PBR	+ \$250	
Dual USB	PBR	+ \$350	
AC/110V and Dual USB	PBR	+ \$600	
Both Hands (Left), 1 Front and 1 Back			
AC/110V	PBL	+ \$250	
Dual USB	PBL	+ \$350	
AC/110V and Dual USB	PBL	+ \$600	

3. Power (Cont.)

Power Location	Code	Price	
Both Hands, 2 Front and Two Back			
AC/110V	PBB	+ \$500	
Dual USB	PBB	+ \$700	
AC/110V and Dual USB	PBB	+ \$1,200	
Power Type	Code	Price	
AC/110V and Dual USB	PT2	Priced by Number of Units and Location	
Dual USB	PT3	Priced by Number of Units and Location	
AC/110V	PT4	Priced by Number of Units and Location	

Power is storm colored. Power not available on 120-Degree models (FS17 SS3, FS17 SS4, FS2 BNS6) or 90-degree models (FS17 SS5, FS2 BNS5).

4. Material

Protection: CAL 133	Code	Price	
Fire Retardancy			
Single Seat	UCAL	+ \$262	
1.5 Seat	UCAL	+ \$393	
90-Degree Corner Seat	UCAL	+ \$377	
120-Degree Seat	UCAL	+ \$377	
Single Bench	UCAL	+ \$88	
1.5 Bench	UCAL	+ \$175	
Angled Bench	UCAL	+ \$175	
90-Degree Bench	UCAL	+ \$175	
120-Degree Bench	UCAL	+ \$175	

Additional CAL 133 information can be found on [page 15](#).

4. Material (Cont.)

Cleaning	Code	Price	
Moisture Barrier: Seat Only			
Single Seat	UM2	+ \$59	
1.5 Seat	UM2	+ \$89	
90-Degree Corner Seat	UM2	+ \$118	
120-Degree Corner Seat	UM2	+ \$118	
Single Bench	UM2	+ \$59	
1.5 Bench	UM2	+ \$118	
Angled Bench	UM2	+ \$118	
90-Degree Bench	UM2	+ \$177	
120-Degree Bench	UM2	+ \$177	
Moisture Barrier: Back Only			
Single Seat	UM1	+ \$59	
1.5 Seat	UM1	+ \$89	
90-Degree Corner Seat	UM1	+ \$118	
120-Degree Corner Seat	UM1	+ \$118	
Moisture Barrier: Seat and Back			
Single Seat	UM3	+ \$118	
1.5 Seat	UM3	+ \$177	
90-Degree Corner Seat	UM3	+ \$236	
120-Degree Corner Seat	UM3	+ \$236	
Fully Upholstered	Code	Price	
Single Seat			
Fabric/Vinyl Grade 1	FG1/VG1	+ \$0	
COM	COM	+ \$65	
Fabric/Vinyl Grade 2	FG2/VG2	+ \$65	
Fabric/Vinyl Grade 3	FG3/VG3	+ \$101	
Fabric/Vinyl Grade 4	FG4/VG4	+ \$144	
Fabric/Vinyl Grade 5	FG5/VG5	+ \$216	
Fabric/Vinyl Grade 6	FG6/VG6	+ \$288	
Fabric/Vinyl Grade 7	FG7/VG7	+ \$360	

4. Material (Cont.)

Fully Upholstered	Code	Price	
1.5 Seat			
Fabric/Vinyl Grade 1	FG1/VG1	+ \$0	
COM	COM	+ \$86	
Fabric/Vinyl Grade 2	FG2/VG2	+ \$86	
Fabric/Vinyl Grade 3	FG3/VG3	+ \$134	
Fabric/Vinyl Grade 4	FG4/VG4	+ \$192	
Fabric/Vinyl Grade 5	FG5/VG5	+ \$288	
Fabric/Vinyl Grade 6	FG6/VG6	+ \$384	
Fabric/Vinyl Grade 7	FG7/VG7	+ \$480	
90-Degree Corner Seat			
Fabric/Vinyl Grade 1	FG1/VG1	+ \$0	
COM	COM	+ \$113	
Fabric/Vinyl Grade 2	FG2/VG2	+ \$113	
Fabric/Vinyl Grade 3	FG3/VG3	+ \$176	
Fabric/Vinyl Grade 4	FG4/VG4	+ \$252	
Fabric/Vinyl Grade 5	FG5/VG5	+ \$378	
Fabric/Vinyl Grade 6	FG6/VG6	+ \$504	
Fabric/Vinyl Grade 7	FG7/VG7	+ \$630	
120-Degree Seat			
Fabric/Vinyl Grade 1	FG1/VG1	+ \$0	
COM	COM	+ \$94	
Fabric/Vinyl Grade 2	FG2/VG2	+ \$94	
Fabric/Vinyl Grade 3	FG3/VG3	+ \$147	
Fabric/Vinyl Grade 4	FG4/VG4	+ \$210	
Fabric/Vinyl Grade 5	FG5/VG5	+ \$315	
Fabric/Vinyl Grade 6	FG6/VG6	+ \$420	
Fabric/Vinyl Grade 7	FG7/VG7	+ \$525	
Single Seat Bench			
Fabric/Vinyl Grade 1	FG1/VG1	+ \$0	
COM	COM	+ \$43	
Fabric/Vinyl Grade 2	FG2/VG2	+ \$43	
Fabric/Vinyl Grade 3	FG3/VG3	+ \$67	
Fabric/Vinyl Grade 4	FG4/VG4	+ \$96	
Fabric/Vinyl Grade 5	FG5/VG5	+ \$144	
Fabric/Vinyl Grade 6	FG6/VG6	+ \$192	
Fabric/Vinyl Grade 7	FG7/VG7	+ \$240	

4. Material (Cont.)

Fully Upholstered	Code	Price
1.5 Seat Bench		
Fabric/Vinyl Grade 1	FG1/VG1	+ \$0
COM	COM	+ \$54
Fabric/Vinyl Grade 2	FG2/VG2	+ \$54
Fabric/Vinyl Grade 3	FG3/VG3	+ \$84
Fabric/Vinyl Grade 4	FG4/VG4	+ \$120
Fabric/Vinyl Grade 5	FG5/VG5	+ \$180
Fabric/Vinyl Grade 6	FG6/VG6	+ \$240
Fabric/Vinyl Grade 7	FG7/VG7	+ \$300
90-Degree Corner Bench		
Fabric/Vinyl Grade 1	FG1/VG1	+ \$0
COM	COM	+ \$54
Fabric/Vinyl Grade 2	FG2/VG2	+ \$54
Fabric/Vinyl Grade 3	FG3/VG3	+ \$84
Fabric/Vinyl Grade 4	FG4/VG4	+ \$120
Fabric/Vinyl Grade 5	FG5/VG5	+ \$180
Fabric/Vinyl Grade 6	FG6/VG6	+ \$240
Fabric/Vinyl Grade 7	FG7/VG7	+ \$300
120-Degree Seat Bench		
Fabric/Vinyl Grade 1	FG1/VG1	+ \$0
COM	COM	+ \$54
Fabric/Vinyl Grade 2	FG2/VG2	+ \$54
Fabric/Vinyl Grade 3	FG3/VG3	+ \$84
Fabric/Vinyl Grade 4	FG4/VG4	+ \$120
Fabric/Vinyl Grade 5	FG5/VG5	+ \$180
Fabric/Vinyl Grade 6	FG6/VG6	+ \$240
Fabric/Vinyl Grade 7	FG7/VG7	+ \$300
Angled End Bench		
Fabric/Vinyl Grade 1	FG1/VG1	+ \$0
COM	COM	+ \$54
Fabric/Vinyl Grade 2	FG2/VG2	+ \$54
Fabric/Vinyl Grade 3	FG3/VG3	+ \$84
Fabric/Vinyl Grade 4	FG4/VG4	+ \$120
Fabric/Vinyl Grade 5	FG5/VG5	+ \$180
Fabric/Vinyl Grade 6	FG6/VG6	+ \$240
Fabric/Vinyl Grade 7	FG7/VG7	+ \$300

MODULAR LOUNGE SEATING

4. Material (Cont.)

Multi-Upholstery	Code	Price
Multi-Upholstery Upcharge	UMU	+ \$75
Single Seat		Seat Only Back Only
Fabric/Vinyl Grade 1	FG1/VG1	+ \$0 + \$0
COM	COM	+ \$43 + \$34
Fabric/Vinyl Grade 2	FG2/VG2	+ \$43 + \$34
Fabric/Vinyl Grade 3	FG3/VG3	+ \$67 + \$52
Fabric/Vinyl Grade 4	FG4/VG4	+ \$96 + \$75
Fabric/Vinyl Grade 5	FG5/VG5	+ \$144 + \$112
Fabric/Vinyl Grade 6	FG6/VG6	+ \$192 + \$150
Fabric/Vinyl Grade 7	FG7/VG7	+ \$240 + \$187
1.5 Seat		Seat Only Back Only
Fabric/Vinyl Grade 1	FG1/VG1	+ \$0 + \$0
COM	COM	+ \$54 + \$38
Fabric/Vinyl Grade 2	FG2/VG2	+ \$54 + \$38
Fabric/Vinyl Grade 3	FG3/VG3	+ \$84 + \$59
Fabric/Vinyl Grade 4	FG4/VG4	+ \$120 + \$84
Fabric/Vinyl Grade 5	FG5/VG5	+ \$180 + \$126
Fabric/Vinyl Grade 6	FG6/VG6	+ \$240 + \$168
Fabric/Vinyl Grade 7	FG7/VG7	+ \$300 + \$210



120-Degree Inner Seat

4. Material (Cont.)

Multi-Upholstery	Code	Price	
90-Degree Seat		Seat Only	Back Only
Fabric/Vinyl Grade 1	FG1/VG1	+ \$0	+ \$0
COM	COM	+ \$59	+ \$65
Fabric/Vinyl Grade 2	FG2/VG2	+ \$59	+ \$65
Fabric/Vinyl Grade 3	FG3/VG3	+ \$92	+ \$101
Fabric/Vinyl Grade 4	FG4/VG4	+ \$132	+ \$144
Fabric/Vinyl Grade 5	FG5/VG5	+ \$198	+ \$216
Fabric/Vinyl Grade 6	FG6/VG6	+ \$264	+ \$288
Fabric/Vinyl Grade 7	FG7/VG7	+ \$330	+ \$360
120-Degree Seat		Seat Only	Back Only
Fabric/Vinyl Grade 1	FG1/VG1	+ \$0	+ \$0
COM	COM	+ \$59	+ \$54
Fabric/Vinyl Grade 2	FG2/VG2	+ \$59	+ \$54
Fabric/Vinyl Grade 3	FG3/VG3	+ \$92	+ \$84
Fabric/Vinyl Grade 4	FG4/VG4	+ \$132	+ \$120
Fabric/Vinyl Grade 5	FG5/VG5	+ \$198	+ \$180
Fabric/Vinyl Grade 6	FG6/VG6	+ \$264	+ \$240
Fabric/Vinyl Grade 7	FG7/VG7	+ \$330	+ \$300

If different fabrics are selected for the seat and back, add the multiple upholstery upcharge as well, even if the fabrics are the same grade.

Please reference the [Textile Reference Guide](#) for pricing on fabric over grade 7. Additional CAL 133 information can be found on [page 15](#).

5. Options

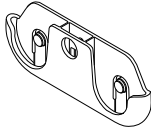
Accessories	Code	Price	
Two Ganging Brackets to Connect to Left-Side or Right-Side	XGV	+ \$52	

One XGV set connects one side of a unit. Order two sets if you need the unit connected on both sides.

6. Packaging

Packaging	Code	Price	
Fully Assembled in Carton	P1	+ \$0	

MODULAR LOUNGE SEATING

SINGLE SEAT AND BENCH SPECIFICATIONS

Model:	PAS FS17 SS1 Single Seat	PAS FS2 BNS1 Single Bench
Dimensions		
Height	31.5"	17.5"
Width	27"	27"
Depth	27"	27"
Seat Depth	17.9"	27"
Seat Height	17.5"	17.5"
Back Height	14.5"	N/A
Materials		
COM (Fully Upholstered)	3 yd	2 yd
COM (Multi-Upholstery) Seat Only	2 yd	N/A
Back Only	1.56 yd	
Weight and Capacity		
Weight	64.5 lb	49 lb
Weight Capacity Warranty	400 lb	400 lb

1.5 SEAT AND BENCH SPECIFICATIONS

Model:	PAS FS17 SS2 1.5 Seat	PAS FS2 BNS2 1.5 Bench
Dimensions		
Height	31.5"	17.5"
Width	36"	36"
Depth	27"	27"
Seat Depth	17.9"	27"
Seat Height	17.5"	17.5"
Back Height	14.5"	N/A
Materials		
COM (Fully Upholstered)	4 yd	2.5 yd
COM (Multi-Upholstery) Seat Only	2.5 yd	N/A
Back Only	1.75 yd	
Weight and Capacity		
Weight	82.5 lb	58.5 lb
Weight Capacity Warranty	800 lb	800 lb

90-DEGREE SEAT AND BENCH SPECIFICATIONS

Model:	PAS FS17 SS5 90-Degree Corner Seat	PAS FS2 BNS5 90-Degree Corner Bench
Dimensions		
Height	31.5"	17.5"
Width	30"	42.5"
Depth	30"	27"
Seat Depth	17.9"	27"
Seat Height	17.5"	17.5"
Back Height	14.5"	N/A
Materials		
COM (Fully Upholstered)	5.25 yd	2.5 yd
COM (Multi-Upholstery)		
Seat Only	2.75 yd	N/A
Back Only	3 yd	
Weight and Capacity		
Weight	86 lb	47 lb
Weight Capacity Warranty	400 lb	400 lb

120-DEGREE SEAT AND BENCH SPECIFICATIONS

Model:	PAS FS17 SS3 120-Degree Inner Seat	PAS FS17 SS4 120-Degree Outer Seat	PAS FS2 BNS6 120-Degree Bench
Dimensions			
Height	31.5"	31.5"	17.5"
Width	47.5"	47.5"	47.5"
Depth	27"	27"	27"
Seat Depth	17.9"	17.9"	27"
Seat Height	17.5"	17.5"	17.5"
Back Height	14.5"	14.5"	N/A
Materials			
COM (Fully Upholstered)	4.38 yd	4.38 yd	2.5 yd
COM (Multi-Upholstery)			
Seat Only	2.75 yd	2.75 yd	N/A
Back Only	2.5 yd	2.5 yd	
Weight and Capacity			
Weight	87.5 lb	78 lb	63 lb
Weight Capacity Warranty	800 lb	800 lb	800 lb

MODULAR LOUNGE SEATING

ANGLED BENCH SPECIFICATIONS

	PAS FS2 BNS3 Right-Angled	PAS FS2 BNS4 Left-Angled
Dimensions		
Height	17.5"	17.5"
Width	47.5"	47.5"
Depth	27"	27"
Seat Depth	27"	27"
Seat Height	17.5"	17.5"
Materials		
COM (Single Upholstery)	2.5 yd	2.5 yd
Weight and Capacity		
Weight	61.5 lb	61.5 lb
Weight Capacity Warranty	800 lb	800 lb



Single Seat Bench

Paséa

TABLES AND OTTOMANS

Lounge that works.

Whether it's to rest your bag or your body, the modularity of the Paséa collection makes it easy to ensure there's always an extra place. This comprehensive collection includes a variety of ottomans and tables that pair perfectly with gapless seats and benches.



Mini Round Ottoman

Large Square Ottoman

EFFECTIVE NOVEMBER 4, 2024

Featured Models

**MINI ROUND
OTTOMAN :: \$868**

Mini round ottoman, multi-upholstery,
grade 1 textiles

**MINI ROUND OTTOMAN
TABLE :: \$1,169**

Mini round ottoman, grade 4 textile,
laminated tabletop



**LARGE SQUARE
OTTOMAN :: \$1,730**

Large square ottoman,
multi-upholstery, grade 4 seat textile
grade 3 chassis textile

Features

- Choose from an assortment of large and mini ottoman and table options, including square and round pieces
- Blend with any environment using graphite or slate base colors
- Tabletops come in five attractive laminate finishes
- Adjustable glides standard on large ottomans
- Fixed multi-surface glides standard on easy-to-move mini ottomans
- 400 lb weight capacity warranty (per seat)

1. Product

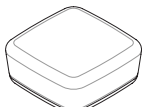
Model	Code	Price	
Mini Round Ottoman	PAS FS1 OS1	\$793	
Mini Square Ottoman	PAS FS1 OS3	\$793	
Large Round Ottoman	PAS FS1 OS2	\$1,517	
Large Square Ottoman	PAS FS1 OS4	\$1,517	

2. Base

Base Finish	Code	Price
Graphite	LBC2	+ \$0
Slate	LBC3	+ \$0

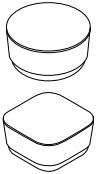
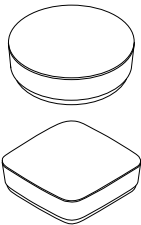

MODULAR TABLES AND OTTOMANS

3. Tabletop

Tabletop Material	Code	Price	
No Tabletop	TM0	+ \$0	
Mini Round or Square Laminate Top	TM3	+ \$328	
Large Round or Square Laminate Top	TM3	+ \$722	

Tabletop Finish	Code	Price	
Field Elm	TL13	+ \$0	
Uptown Walnut	TL14	+ \$0	
Skyline Walnut	TL15	+ \$0	
Frosty White	TL16	+ \$0	
Classic Linen	TL17	+ \$0	

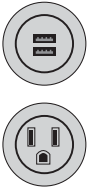
4. Power

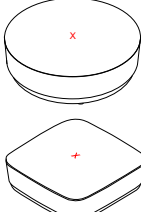
Power Type	Code	Price	
AC/110V and Dual USB	PT2	+ \$300	
Dual USB	PT3	+ \$175	
AC/110V	PT4	+ \$125	
Power Location	Code	Price	
Top Center	PTCC	Priced by Power Type	

Power is only available on large ottomans with tabletops. Power is located in the center of the laminate top.

5. Material

Protection	Code	Price	
Fire Retardancy		Mini Ottoman	Large Ottoman
CAL 133	UCAL	+ \$88	+ \$262
Cleaning	Code	Price	
Moisture Barrier		Mini Ottoman	Large Ottoman
Seat Only	UM2	+ \$35	+ \$177
Fully Upholstered	Code	Price	
Round		Mini Ottoman	Large Ottoman
Fabric/Vinyl Grade 1	FG1/VG1	+ \$0	+ \$0
COM	COM	+ \$38	+ \$72
Fabric/Vinyl Grade 2	FG2/VG2	+ \$38	+ \$72
Fabric/Vinyl Grade 3	FG3/VG3	+ \$59	+ \$112
Fabric/Vinyl Grade 4	FG4/VG4	+ \$84	+ \$161
Fabric/Vinyl Grade 5	FG5/VG5	+ \$126	+ \$241
Fabric/Vinyl Grade 6	FG6/VG6	+ \$168	+ \$322
Fabric/Vinyl Grade 7	FG7/VG7	+ \$210	+ \$402
Square		Mini Ottoman	Large Ottoman
Fabric/Vinyl Grade 1	FG1/VG1	+ \$0	+ \$0
COM	COM	+ \$40	+ \$74
Fabric/Vinyl Grade 2	FG2/VG2	+ \$40	+ \$74
Fabric/Vinyl Grade 3	FG3/VG3	+ \$63	+ \$115
Fabric/Vinyl Grade 4	FG4/VG4	+ \$90	+ \$165
Fabric/Vinyl Grade 5	FG5/VG5	+ \$135	+ \$247
Fabric/Vinyl Grade 6	FG6/VG6	+ \$180	+ \$330
Fabric/Vinyl Grade 7	FG7/VG7	+ \$225	+ \$412
Round or Square With Tabletop		Mini Ottoman	Large Ottoman
Fabric/Vinyl Grade 1	FG1/VG1	+ \$0	+ \$0
COM	COM	+ \$22	+ \$40
Fabric/Vinyl Grade 2	FG2/VG2	+ \$22	+ \$40
Fabric/Vinyl Grade 3	FG3/VG3	+ \$34	+ \$63
Fabric/Vinyl Grade 4	FG4/VG4	+ \$48	+ \$90
Fabric/Vinyl Grade 5	FG5/VG5	+ \$72	+ \$135
Fabric/Vinyl Grade 6	FG6/VG6	+ \$96	+ \$180
Fabric/Vinyl Grade 7	FG7/VG7	+ \$120	+ \$225

Cleaning and protection options are not applicable on ottomans with laminate tops.

5. Material (Cont.)

Multi-Upholstery	Code	Price	
Multi-Upholstery Upcharge	UMU	+ \$75	
Mini Round or Square Ottoman	Seat	Chassis	
Fabric/Vinyl Grade 1	FG1/VG1	+ \$0	+ \$0
COM	COM	+ \$22	+ \$22
Fabric/Vinyl Grade 2	FG2/VG2	+ \$22	+ \$22
Fabric/Vinyl Grade 3	FG3/VG3	+ \$34	+ \$34
Fabric/Vinyl Grade 4	FG4/VG4	+ \$48	+ \$48
Fabric/Vinyl Grade 5	FG5/VG5	+ \$72	+ \$72
Fabric/Vinyl Grade 6	FG6/VG6	+ \$96	+ \$96
Fabric/Vinyl Grade 7	FG7/VG7	+ \$120	+ \$120
Large Round or Square Ottoman	Seat	Chassis	
Fabric/Vinyl Grade 1	FG1/VG1	+ \$0	+ \$0
COM	COM	+ \$34	+ \$40
Fabric/Vinyl Grade 2	FG2/VG2	+ \$34	+ \$40
Fabric/Vinyl Grade 3	FG3/VG3	+ \$52	+ \$63
Fabric/Vinyl Grade 4	FG4/VG4	+ \$75	+ \$90
Fabric/Vinyl Grade 5	FG5/VG5	+ \$112	+ \$135
Fabric/Vinyl Grade 6	FG6/VG6	+ \$150	+ \$180
Fabric/Vinyl Grade 7	FG7/VG7	+ \$187	+ \$225

Ottomans with tabletops are only available fully upholstered.

If different fabrics are selected for the seat and chassis, add the multi-upholstery upcharge as well, even if the fabrics are the same grade

Please reference the [Textile Reference Guide](#) for pricing on fabric over grade 7. Additional CAL 133 information can be found on [page 15](#).

6. Packaging

Packaging	Code	Price	
Fully Assembled in Carton	P1	+ \$0	

SPECIFICATIONS: MINI OTTOMAN

Model:	PAS FS1 OS1 Mini Round Ottoman	PAS FS1 OS3 Mini Square Ottoman
Dimensions		
Height	17.5"	17.5"
Width	24"	24"
Depth	24"	24"
Seat Depth	24"	24"
Seat Height	17.5"	17.5"
Materials		
COM (Fully Upholstered)	1.75 lb	1.88 yd
COM (Multi-Upholstery)		
Seat Top Only	1 yd	1 yd
Chassis Only	1 yd	1 yd
Weight and Capacity		
Weight	34 lb	43.5 lb
Weight Capacity Warranty	400 lb	400 lb

SPECIFICATIONS: LARGE OTTOMAN

Model:	PAS FS1 OS2 Large Round Ottoman	PAS FS1 OS4 Large Square Ottoman
Dimensions		
Height	17.5"	17.5"
Width	40"	40"
Depth	40"	40"
Seat Depth	40"	40"
Seat Height	17.5"	17.5"
Materials		
COM (Fully Upholstered)	3.35 yd	3.44 yd
COM (Multi-Upholstery)		
Seat Top Only	1.56 yd	1.56 yd
Chassis Only	1.88 yd	1.88 yd
Weight and Capacity		
Weight	74.5 lb	89.5 lb
Weight Capacity Warranty	800 lb	800 lb

MODULAR TABLES AND OTTOMANS

SPECIFICATIONS: MINI OTTOMAN TABLES

Model:	FS1 OS1 Mini Round Table	FS1 OS3 Mini Square Table
Dimensions		
Height	13"	13"
Width	24"	24"
Depth	24"	24"
Materials		
COM	1.25 yd	1.25 yd
Weight and Capacity		
Weight	37 lb	37 lb
Weight Capacity Warranty	400 lb	400 lb

SPECIFICATIONS: LARGE OTTOMAN TABLES

Model:	FS1 OS2 Large Round Table	FS1 OS4 Large Square Table
Dimensions		
Height	13.3"	13.3"
Width	40"	40"
Depth	40"	40"
Materials		
COM	2 yd	2 yd
Weight and Capacity		
Weight	85 lb	85 lb
Weight Capacity Warranty	800 lb	800 lb

Paséa

INLINE TABLES

Lounge that works.

Whether it's to rest your bag or your body, the modularity of the Paséa collection makes it easy to ensure there's always an extra place. This comprehensive collection includes a variety of inline tables that pair perfectly with gapless seats and benches.



13" x 27" Table
Featured with Uptown Walnut laminate
and SitOnIt Seating's Venice — Mainstream

27" x 27" Table
Featured with Skyline Walnut laminate
and SitOnIt Seating's Huntington — Splash

EFFECTIVE NOVEMBER 4, 2024

Featured Models

13" x 27" :: \$1,241

13" x 27" table, laminate top,
grade 1 textile

27" x 27" :: \$1,661

27" x 27" table, laminate top,
grade 1 textile

90° CORNER :: \$2,570

90-degree corner table, laminate top,
grade 1 textile

Features

- Choose from an assortment of large and mini ottoman
Designed by Q Design
- Part of a comprehensive collection that also includes seats, benches and ottomans
- Provide extra convenience with available AC and USB power options
- Three tables that are designed to be used inline with Paséa seats and benches: the 13" x 27" table, 27" x 27" table and the 90-degree corner table
- Adjustable glides standard on all Paséa tables (except mini ottoman tables).
- Blend with any environment using graphite or slate base colors
- Tabletops come in five attractive laminate finishes

1. Product

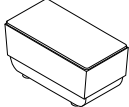
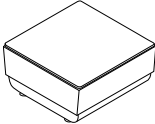
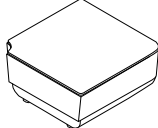
Model	Code	Price	
13" x 27" Table	FS18 BNS7	\$1,241	
27" x 27" Table	FS18 BNS1	\$1,661	
90-Degree Corner Table	FS18 BNS5	\$2,570	

2. Table Base



Base Finish	Code	Price
Graphite	LBC2	+ \$0
Slate	LBC3	+ \$0

INLINE TABLES

3. Tabletop

Top Material	Code	Price
Laminate	TM3	+ \$0
Laminate Finish	Code	Price
Field Elm	TL13	+ \$0
Uptown Walnut	TL14	+ \$0
Skyline Walnut	TL15	+ \$0
Frosty White	TL16	+ \$0
Classic Linen	TL17	+ \$0

4. Power

Power Type	Code	Price	
AC/110V and Dual USB	PT2	+ \$300	
Dual USB	PT3	+ \$175	
AC/110V	PT4	+ \$125	

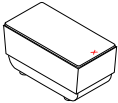
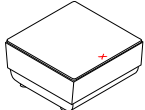
Power Location	Code	Price	
Top Rear	PTRC	Priced by Power Type	
Top Center	PTCC	Priced by Power Type	

13" x 27" (FS18 BNS7) and 27" x 27" (FS18 BNS1) tables are available with top rear power only. 90-degree corner table (FS18 BNS5) is available with top center power only.

5. Material

Fully Upholstered	Code	Price	
13" x 27" Table			
Fabric/Vinyl Grade 1	FG1/VG1	+ \$0	
COM	COM	+ \$27	
Fabric/Vinyl Grade 2	FG2/VG2	+ \$27	
Fabric/Vinyl Grade 3	FG3/VG3	+ \$42	
Fabric/Vinyl Grade 4	FG4/VG4	+ \$60	
Fabric/Vinyl Grade 5	FG5/VG5	+ \$90	
Fabric/Vinyl Grade 6	FG6/VG6	+ \$120	
Fabric/Vinyl Grade 7	FG7/VG7	+ \$150	
27" x 27" Table			
Fabric/Vinyl Grade 1	FG1/VG1	+ \$0	
COM	COM	+ \$40	
Fabric/Vinyl Grade 2	FG2/VG2	+ \$40	
Fabric/Vinyl Grade 3	FG3/VG3	+ \$63	
Fabric/Vinyl Grade 4	FG4/VG4	+ \$90	
Fabric/Vinyl Grade 5	FG5/VG5	+ \$135	
Fabric/Vinyl Grade 6	FG6/VG6	+ \$180	
Fabric/Vinyl Grade 7	FG7/VG7	+ \$225	
90-Degree Corner Table			
Fabric/Vinyl Grade 1	FG1/VG1	+ \$0	
COM	COM	+ \$40	
Fabric/Vinyl Grade 2	FG2/VG2	+ \$40	
Fabric/Vinyl Grade 3	FG3/VG3	+ \$63	
Fabric/Vinyl Grade 4	FG4/VG4	+ \$90	
Fabric/Vinyl Grade 5	FG5/VG5	+ \$135	
Fabric/Vinyl Grade 6	FG6/VG6	+ \$180	
Fabric/Vinyl Grade 7	FG7/VG7	+ \$225	

Please reference the [Textile Reference Guide](#) for pricing on fabric over grade 7. Additional CAL 133 information can be found on [page 15](#).

INLINE TABLES

6. Packaging

Packaging	Code	Price	
Fully Assembled in Carton	P1	+ \$0	

SPECIFICATIONS

Model:	FS18 BNS7 13" x 27" Table	FS18 BNS1 27" x 27" Table	FS18 BNS5 90-Degree Corner Table
Dimensions			
Height	13.3"	13.3"	13.3"
Width	13.4"	27"	30"
Depth	27"	27"	30"
Materials			
COM	1.25 yd	1.5 yd	1.5 yd
Weight and Capacity			
Weight	35 lb	64 lb	64 lb
Weight Capacity Warranty	400 lb	400 lb	400 lb

Sable

LOUNGE SEATING

Modern lines. Classic comfort.

Lift up any space with our elegantly elevated, subtly sophisticated Sable. With impeccable tailoring and refined styling, this residential-inspired collection gives any environment the perfect place to relax reliably (and comfortably).



Settee

*Featured with SitOnIt Seating's Aline Plus – Waterfall
and Manitoba Wood Grain Legs*

EFFECTIVE NOVEMBER 4, 2024

Featured Models

SETTEE :: \$3,798

Fully upholstered, wood grain legs,
grade 3 textile

CLUB CHAIR :: \$2,301

Fully upholstered, wood grain legs,
grade 1 textile

2-SEAT BENCH :: \$2,103

Fully upholstered, grade 4 textile

Features

- Residential-inspired design with contract-grade construction
- Modern lines meet timeless comfort across an array of configurations
- Wraparound seat cushions add a touch of design detail and extra comfort
- Hidden clean-out is perfect for healthcare and high-traffic spaces
- Customizable steel legs with powder-coated or wood grain finishes
- Modular frame construction allows for easy parts replacement

1. Product

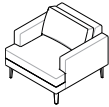
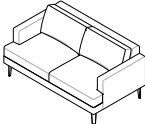
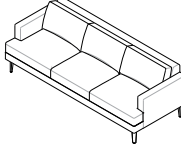
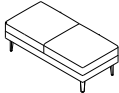
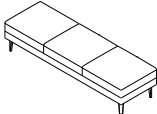
Collection	Code	Price	
Sable Lounge	2060	Priced by Product Type	
Product Type	Code	Price	
Club Chair With Arms	FS30 CN1	\$2,251	
Settee With Arms	FS45 CN2	\$3,396	
Sofa With Arms	FS49 CN3	\$4,409	
2-Seat Bench	FS59 CN2	\$1,876	
3-Seat Bench	FS60 CN3	\$2,345	

LOUNGE SEATING

2. Leg

Leg Style	Code	Price	
Tapered Metal Leg	LS26	+ \$0	
Metal Leg Finish	Code	Price	
Charcoal	FCM4	+ \$0	
Natural Steel	FCM11	+ \$0	
Neo Wood Grain	FCM14	+ \$50	
Manitoba Wood Grain	FCM13	+ \$50	
Glides	Code	Price	
Standard Multi-Surface Glides	GL1	+ \$0	

3. Material

Cleaning	Code	Price		
Moisture Barrier: Seats		Chair	Settee	Sofa
None	UM0	+ \$0	+ \$0	+ \$0
Seat Only	UM2	+\$59	+\$118	+\$177
Back Only	UM1	+\$59	+\$118	+\$177
Seat and Back	UM3	+\$118	+\$236	+\$354
Moisture Barrier: Benches			2-Seat	3-Seat
Seat Only	UM2		+\$118	+\$177
Clean-Out Feature				
Hidden Clean-Out	SX4	+ \$0		
Fully Upholstered	Code	Price		
Club Chair				
Fabric/Vinyl Grade 1	FG1/VG1	+ \$0		
COM	COM	+ \$153		
Fabric/Vinyl Grade 2	FG2/VG2	+ \$153		
Fabric/Vinyl Grade 3	FG3/VG3	+ \$239		
Fabric/Vinyl Grade 4	FG4/VG4	+ \$341		
Fabric/Vinyl Grade 5	FG5/VG5	+ \$512		
Fabric/Vinyl Grade 6	FG6/VG6	+ \$682		
Fabric/Vinyl Grade 7	FG7/VG7	+ \$853		
Leather Grade 1	LG1	+ \$1,275		
COL	COL	+ \$1,615		
Leather Grade 2	LG2	+ \$1,615		
Leather Grade 3	LG3	+ \$2,040		

3. Material (Cont.)

Fully Upholstered	Code	Price
Settee		
Fabric/Vinyl Grade 1	FG1/VG1	+ \$0
COM	COM	+ \$226
Fabric/Vinyl Grade 2	FG2/VG2	+ \$226
Fabric/Vinyl Grade 3	FG3/VG3	+ \$352
Fabric/Vinyl Grade 4	FG4/VG4	+ \$503
Fabric/Vinyl Grade 5	FG5/VG5	+ \$755
Fabric/Vinyl Grade 6	FG6/VG6	+ \$1,007
Fabric/Vinyl Grade 7	FG7/VG7	+ \$1,259
Leather Grade1	LG1	+ \$1,875
COL	COL	+ \$2,375
Leather Grade 2	LG2	+ \$2,375
Leather Grade 3	LG3	+ \$3,000
Sofa		
Fabric/Vinyl Grade 1	FG1/VG1	+ \$0
COM	COM	+ \$307
Fabric/Vinyl Grade 2	FG2/VG2	+ \$307
Fabric/Vinyl Grade 3	FG3/VG3	+ \$477
Fabric/Vinyl Grade 4	FG4/VG4	+ \$682
Fabric/Vinyl Grade 5	FG5/VG5	+ \$1,023
Fabric/Vinyl Grade 6	FG6/VG6	+ \$1,365
Fabric/Vinyl Grade 7	FG7/VG7	+ \$1,706
Leather Grade1	LG1	+ \$2,475
COL	COL	+ \$3,135
Leather Grade 2	LG2	+ \$3,135
Leather Grade 3	LG3	+ \$3,960
2-Seat Bench		
Fabric/Vinyl Grade 1	FG1/VG1	+ \$0
COM	COM	+ \$102
Fabric/Vinyl Grade 2	FG2/VG2	+ \$102
Fabric/Vinyl Grade 3	FG3/VG3	+ \$159
Fabric/Vinyl Grade 4	FG4/VG4	+ \$227
Fabric/Vinyl Grade 5	FG5/VG5	+ \$341
Fabric/Vinyl Grade 6	FG6/VG6	+ \$455
Fabric/Vinyl Grade 7	FG7/VG7	+ \$569
Leather Grade1	LG1	+ \$750
COL	COL	+ \$950
Leather Grade 2	LG2	+ \$950
Leather Grade 3	LG3	+ \$1,200

3. Material (Cont.)

Fully Upholstered	Code	Price		
3-Seat-Bench				
Fabric/Vinyl Grade 1	FG1/VG1	+ \$0		
COM	COM	+ \$131		
Fabric/Vinyl Grade 2	FG2/VG2	+ \$131		
Fabric/Vinyl Grade 3	FG3/VG3	+ \$205		
Fabric/Vinyl Grade 4	FG4/VG4	+ \$292		
Fabric/Vinyl Grade 5	FG5/VG5	+ \$439		
Fabric/Vinyl Grade 6	FG6/VG6	+ \$585		
Fabric/Vinyl Grade 7	FG7/VG7	+ \$731		
Leather Grade1	LG1	+ \$975		
COL	COL	+ \$1,235		
Leather Grade 2	LG2	+ \$1,235		
Leather Grade 3	LG2	+ \$1,560		
Multi-Upholstery	Code	Price		
Multi-Upholstery Upcharge	UMU	+ \$75		
Club Chair	Seat	Back	Shell	
Fabric/Vinyl Grade 1	FG1/VG1	+ \$0	+ \$0	+ \$0
COM	COM	+ \$58	+ \$37	+ \$110
Fabric/Vinyl Grade 2	FG2/VG2	+ \$58	+ \$37	+ \$110
Fabric/Vinyl Grade 3	FG3/VG3	+ \$91	+ \$57	+ \$171
Fabric/Vinyl Grade 4	FG4/VG4	+ \$130	+ \$81	+ \$244
Fabric/Vinyl Grade 5	FG5/VG5	+ \$195	+ \$122	+ \$366
Fabric/Vinyl Grade 6	FG6/VG6	+ \$260	+ \$162	+ \$487
Fabric/Vinyl Grade 7	FG7/VG7	+ \$325	+ \$203	+ \$609
Leather Grade 1	LG1	+ \$450	+ \$300	+ \$900
COL	COL	+ \$570	+ \$380	+ \$1,140
Leather Grade 2	LG2	+ \$570	+ \$380	+ \$1,140
Leather Grade 3	LG3	+ \$720	+ \$480	+ \$1,440
Settee	Seat	Back	Shell	
Fabric/Vinyl Grade 1	FG1/VG1	+ \$0	+ \$0	+ \$0
COM	COM	+ \$80	+ \$58	+ \$139
Fabric/Vinyl Grade 2	FG2/VG2	+ \$80	+ \$58	+ \$139
Fabric/Vinyl Grade 3	FG3/VG3	+ \$125	+ \$91	+ \$216
Fabric/Vinyl Grade 4	FG4/VG4	+ \$179	+ \$130	+ \$309
Fabric/Vinyl Grade 5	FG5/VG5	+ \$268	+ \$195	+ \$463
Fabric/Vinyl Grade 6	FG6/VG6	+ \$357	+ \$260	+ \$617
Fabric/Vinyl Grade 7	FG7/VG7	+ \$447	+ \$325	+ \$772
Leather Grade 1	LG1	+ \$600	+ \$450	+ \$1,125
COL	COL	+ \$760	+ \$570	+ \$1,425
Leather Grade 2	LG2	+ \$760	+ \$570	+ \$1,425
Leather Grade 3	LG3	+ \$960	+ \$720	+ \$1,800

3. Material (Cont.)

Multi-Upholstery	Code	Price		
		Seat	Back	Shell
Sofa				
Fabric/Vinyl Grade 1	FG1/VG1	+ \$0	+ \$0	+ \$0
COM	COM	+ \$110	+ \$102	+ \$168
Fabric/Vinyl Grade 2	FG2/VG2	+ \$110	+ \$102	+ \$168
Fabric/Vinyl Grade 3	FG3/VG3	+ \$171	+ \$159	+ \$261
Fabric/Vinyl Grade 4	FG4/VG4	+ \$244	+ \$227	+ \$374
Fabric/Vinyl Grade 5	FG5/VG5	+ \$366	+ \$341	+ \$560
Fabric/Vinyl Grade 6	FG6/VG6	+ \$487	+ \$455	+ \$747
Fabric/Vinyl Grade 7	FG7/VG7	+ \$609	+ \$569	+ \$934
Leather Grade 1	LG1	+ \$825	+ \$675	+ \$1,350
COL	COL	+ \$1,045	+ \$855	+ \$1,710
Leather Grade 2	LG2	+ \$1,045	+ \$855	+ \$1,710
Leather Grade 3	LG3	+ \$1,320	+ \$1,080	+ \$2,160

If different fabrics are selected for the seat and back/arms, add the multiple upholstery upcharge as well, even if the fabrics are the same grade.

Please reference the [Textile Reference Guide](#) for pricing on fabric over grade 7 and leather over grade 3.

4. Packaging

Packaging	Code	Price
Fully Assembled in a Carton	P1	+ \$0



Club Chair
 Featured with SitOnIt Seating's Huntington — Fleece
 and Neo Wood Grain Legs

SABLE

EFFECTIVE NOVEMBER 4, 2024 | GSA SIN #: 33721

SPECIFICATIONS

Model: 2060	FS30 CN1 Club Chair	FS45 CN2 Settee	FS49 CN3 Sofa
Dimensions			
Width	34.5"	60.5"	86.5"
Height	32"	32"	32"
Depth	34.75"	34.75"	34.75"
Seat Width	26"	52"	78"
Seat Depth	20.5"	20.5"	20.5"
Seat Height	18"	18"	18"
Back Height	14"	14"	14"
Arm Width	4"	4"	4"
Materials			
COM (Fully Upholstered)	6.5 yd	11 yd	14 yd
COM (Multi-Upholstery)			
Seat Only	2.5 yd	3 yd	4.25 yd
Back Only	1.5 yd	2.75 yd	4 yd
Shell Only	5 yd	5 yd	7.5 yd
COL (Fully Upholstered)	119 sq ft	175 sq ft	230 sq ft
COL (Multi-Upholstery)			
Seat Only	42 sq ft	56 sq ft	75 sq ft
Back Only	28 sq ft	42 sq ft	60 sq ft
Shell Only	84 sq ft	100 sq ft	120 sq ft
Weight and Capacity			
Weight	80 lb	110 lb	190 lb
Weight Capacity Warranty	400 lb	600 lb	750 lb

SPECIFICATIONS

Model: 2060	FS59 CN2 2-Seat Bench	FS60 CN3 3-Seat Bench
Dimensions		
Width	52"	78"
Height	18"	18"
Depth	24"	24"
Seat Width	52"	78"
Seat Depth	24"	24"
Seat Height	18"	18"
Arm Width	4"	4"
Materials		
COM (Fully Upholstered)	4 yd	5 yd
COL (Fully Upholstered)	70 sq ft	90 sq ft
Weight and Capacity		
Weight	65 lb	85 lb
Weight Capacity Warranty	600 lb	750 lb



2-Seat Bench
 Featured with SitOnIt Seating's Sili-Tex Leather — Black
 and Natural Steel Legs

Visit Modular

CLUB CHAIR AND OTTOMAN

Sit. Stay awhile.

With contemporary aesthetics, the Visit Modular collection features flexible modularity and arm options for inventive space planning. Link arm and armless models with ganging brackets and an ottoman for common areas and waiting rooms. Handy seat-back handles and functional tablet arms make Visit Modular perfect for collaborative spaces and pull-up meetings.

Our customizable lounge line is now even more convenient thanks to our new power modules. Crafted with minimal seams for smoother integration and a cleaner look, they can be installed on either the fronts or sides of our models.



Armless Club Chair

EFFECTIVE NOVEMBER 4, 2024

Featured Models

OTTOMAN :: \$1,388

Ottoman, fully upholstered, plastic feet, multi-upholstery, grade 5 top and front textile, grade 4 side textile

ARMLESS CLUB CHAIR :: \$2,108

Club chair, armless, wood tapered cylinder feet, multi-upholstery, grade 3 textiles

CLUB CHAIR WITH ARMS :: \$2,219

Club chair, two upholstered arms, brushed aluminum pole feet, fully upholstered, grade 3 textile

Features

- Armless chair and ottoman for modular seating
- Ganging brackets
- Two arm styles: armless or upholstered
- Optional tablet arm
- Back hook or handle
- Optional power module available
- 300 lb weight capacity warranty

1. Product

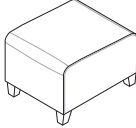
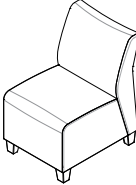
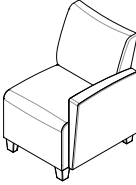
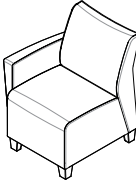
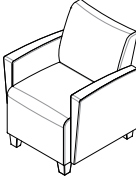
Model and Arm Style	Code	Price	
Ottoman	VS FS1	\$1,133	
Armless Club Chair	VS	\$1,749	
Club Chair With Upholstered Left Arm	VS FS12	\$1,849	
Club Chair With Upholstered Right Arm	VS FS10	\$1,849	
Club Chair With Upholstered Left and Right Arms	VS FS8	\$1,949	

Left and right arms are designated from the seated position.

CLUB CHAIR AND OTTOMAN

2. Back

Back Options	Code	Price	
Hook/Handle (Not Available on Ottoman)	BX1	+ \$147	

3. Tablet Arm

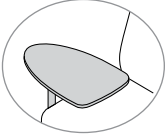
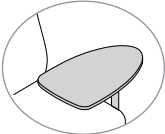

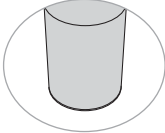
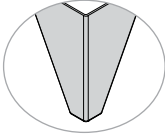
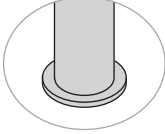

Tablet Arm	Code	Price	
Tablet Arm, Right, Black Pole	AX3	+ \$342	
Tablet Arm, Right, Silver Pole	AX2	+ \$342	
Tablet Arm, Left, Black Pole	AX6	+ \$342	
Tablet Arm, Left, Silver Pole	AX5	+ \$342	

Tablet arms are available on the left or right side if the chair is configured as armless.

4. Foot

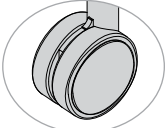
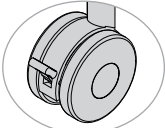
Front Foot Style and Color	Code	Price	
Feet			
Standard Plastic, Black	LS1	+ \$0	
Wood Tapered Square	LS12	+ \$70	
Wood Tapered Cylinder	LS11	+ \$70	
Metal Angular, Brushed Aluminum	LS6	+ \$60	
Metal 1.5" Pole, Brushed Aluminum	LS7	+ \$60	
Metal 1.5" Pole, Silver Powder Coat	LS8	+ \$60	

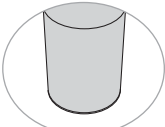
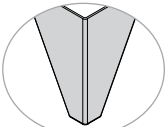
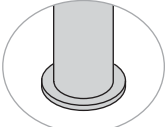
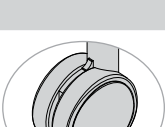
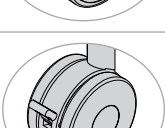
4. Foot (Cont.)

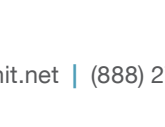
Front Foot Style and Color	Code	Price	
Casters			
Non-Locking Caster, Black	LS2	+ \$50	
Non-Locking Caster, Silver	LS3	+ \$50	
Locking Caster, Black	LS4	+ \$60	
Locking Caster, Silver	LS5	+ \$60	
Back Foot Style and Color	Code	Price	
Feet			
Standard Plastic, Black	LS1	+ \$0	
Wood Tapered Square	LS12	+ \$70	
Wood Tapered Cylinder	LS11	+ \$70	
Metal Angular, Brushed Aluminum	LS6	+ \$60	
Metal 1.5" Pole, Brushed Aluminum	LS7	+ \$60	
Metal 1.5" Pole, Silver Powder Coat	LS8	+ \$60	
Casters			
Non-Locking Caster, Black	LS2	+ \$50	
Non-Locking Caster, Silver	LS3	+ \$50	
Locking Caster, Black	LS4	+ \$60	
Locking Caster, Silver	LS5	+ \$60	

CLUB CHAIR AND OTTOMAN

5. Frame (For Wooden Feet L11/L12)

Frame Finish Color	Code	Price	
Clear Maple	FCW1	+ \$0	
Medium Cherry	FCW2	+ \$0	
Amber Mahogany	FCW3	+ \$0	
Espresso	FCW4	+ \$0	
Stain-to-Match	STM	+ \$70	

Stain-to-Match (STM) requires a one-time set up fee of \$275.

6. Power

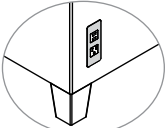
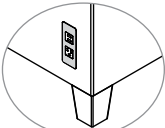
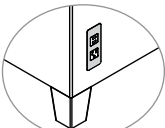
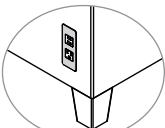
Location	Code	Price	
Right Hand, Front of Chair	PFR	+ \$250	
Left Hand, Front of Chair	PFL	+ \$250	
Right Hand, Side of Chair (Only Available on Armless Model)	PSR	+ \$250	
Left Hand, Side of Chair (Only Available on Armless Model)	PSL	+ \$250	
Color	Code	Price	
Silver	PC2	+ \$0	
Black	PC1	+ \$0	

Power only available on the side of chairs.

Each chair can only have power specified in one of the location options. Power cannot be specified on the same side of a chair where a tablet arm or magazine rack is specified.

7. Material

Protection	Code	Price	
Fire Retardancy			
CAL 133	UCAL	+ \$262	
Cleaning	Code	Price	
Moisture Barrier			
Seat Only	UM2	+ \$59	
Back Only	UM1	+ \$59	
Seat and Back	UM3	+ \$118	
Upholstery	Code	Price	
Fully Upholstered		Two Arms	One Arm
Fabric/Vinyl Grade 1	FG1/VG1	+ \$0	+ \$0
COM	COM	+ \$50	+ \$39
Fabric/Vinyl Grade 2	FG2/VG2	+ \$50	+ \$39
Fabric/Vinyl Grade 3	FG3/VG3	+ \$150	+ \$119
Fabric/Vinyl Grade 4	FG4/VG4	+ \$250	+ \$198
Fabric/Vinyl Grade 5	FG5/VG5	+ \$375	+ \$298
Fabric/Vinyl Grade 6	FG6/VG6	+ \$550	+ \$439
Fabric/Vinyl Grade 7	FG7/VG7	+ \$775	+ \$616
Leather Grade 1	LG1	+ \$800	+ \$636
COL	COL	+ \$1,050	+ \$834
Leather Grade 2	LG2	+ \$1,050	+ \$834
Leather Grade 3	LG3	+ \$1,450	+ \$1,152
Fully Upholstered		Armless	Ottoman
Fabric/Vinyl Grade 1	FG1/VG1	+ \$0	+ \$0
COM	COM	+ \$35	+ \$23
Fabric/Vinyl Grade 2	FG2/VG2	+ \$35	+ \$23
Fabric/Vinyl Grade 3	FG3/VG3	+ \$105	+ \$68
Fabric/Vinyl Grade 4	FG4/VG4	+ \$175	+ \$113
Fabric/Vinyl Grade 5	FG5/VG5	+ \$263	+ \$169
Fabric/Vinyl Grade 6	FG6/VG6	+ \$385	+ \$248
Fabric/Vinyl Grade 7	FG7/VG7	+ \$543	+ \$349
Leather Grade 1	LG1	+ \$556	+ \$363
COL	COL	+ \$730	+ \$476
Leather Grade 2	LG2	+ \$730	+ \$476
Leather Grade 3	LG3	+ \$1,008	+ \$657

CLUB CHAIR AND OTTOMAN

7. Material (Cont.)

Multi-Upholstery		Price	
Multi-Upholstery	UMU	+ \$113	
Seat or Top and Front Textile Only		Two Arms	One Arm
Fabric/Vinyl Grade 1	FG1/VG1	+ \$0	+ \$0
COM	COM	+ \$15	+ \$15
Fabric/Vinyl Grade 2	FG2/VG2	+ \$15	+ \$15
Fabric/Vinyl Grade 3	FG3/VG3	+ \$45	+ \$45
Fabric/Vinyl Grade 4	FG4/VG4	+ \$74	+ \$74
Fabric/Vinyl Grade 5	FG5/VG5	+ \$111	+ \$111
Fabric/Vinyl Grade 6	FG6/VG6	+ \$163	+ \$163
Fabric/Vinyl Grade 7	FG7/VG7	+ \$229	+ \$229
Leather Grade 1	LG1	+ \$237	+ \$237
COL	COL	+ \$310	+ \$310
Leather Grade 2	LG2	+ \$310	+ \$310
Leather Grade 3	LG3	+ \$428	+ \$428
Seat or Top and Front Textile Only		Armless	Ottoman
Fabric/Vinyl Grade 1	FG1/VG1	+ \$0	+ \$0
COM	COM	+ \$18	+ \$12
Fabric/Vinyl Grade 2	FG2/VG2	+ \$18	+ \$12
Fabric/Vinyl Grade 3	FG3/VG3	+ \$53	+ \$34
Fabric/Vinyl Grade 4	FG4/VG4	+ \$88	+ \$57
Fabric/Vinyl Grade 5	FG5/VG5	+ \$132	+ \$85
Fabric/Vinyl Grade 6	FG6/VG6	+ \$193	+ \$124
Fabric/Vinyl Grade 7	FG7/VG7	+ \$272	+ \$175
Leather Grade 1	LG1	+ \$278	+ \$182
COL	COL	+ \$365	+ \$238
Leather Grade 2	LG2	+ \$365	+ \$238
Leather Grade 3	LG3	+ \$504	+ \$329

If different fabrics are selected for the seat and back, add the multiple upholstery upcharge as well, even if the fabrics are the same grade

Please reference the [Textile Reference Guide](#) for pricing on fabric over grade 7 and leather over grade 3. Additional CAL 133 information can be found on [page 15](#).



Ottoman

7. Material (Cont.)

Multi-Upholstery	Code	Price	
Back or Side Textile Only		Two Arms	One Arm
Fabric/Vinyl Grade 1	FG1/VG1	+ \$0	+ \$0
COM	COM	+ \$15	+ \$15
Fabric/Vinyl Grade 2	FG2/VG2	+ \$15	+ \$15
Fabric/Vinyl Grade 3	FG3/VG3	+ \$45	+ \$45
Fabric/Vinyl Grade 4	FG4/VG4	+ \$74	+ \$74
Fabric/Vinyl Grade 5	FG5/VG5	+ \$111	+ \$111
Fabric/Vinyl Grade 6	FG6/VG6	+ \$163	+ \$163
Fabric/Vinyl Grade 7	FG7/VG7	+ \$229	+ \$229
Leather Grade 1	LG1	+ \$237	+ \$237
COL	COL	+ \$310	+ \$310
Leather Grade 2	LG2	+ \$310	+ \$310
Leather Grade 3	LG3	+ \$428	+ \$428
Back or Side Textile Only		Armless	Ottoman
Fabric/Vinyl Grade 1	FG1/VG1	+ \$0	+ \$0
COM	COM	+ \$18	+ \$12
Fabric/Vinyl Grade 2	FG2/VG2	+ \$18	+ \$12
Fabric/Vinyl Grade 3	FG3/VG3	+ \$53	+ \$34
Fabric/Vinyl Grade 4	FG4/VG4	+ \$88	+ \$57
Fabric/Vinyl Grade 5	FG5/VG5	+ \$132	+ \$85
Fabric/Vinyl Grade 6	FG6/VG6	+ \$193	+ \$124
Fabric/Vinyl Grade 7	FG7/VG7	+ \$272	+ \$175
Leather Grade 1	LG1	+ \$278	+ \$182
COL	COL	+ \$365	+ \$238
Leather Grade 2	LG2	+ \$365	+ \$238
Leather Grade 3	LG3	+ \$504	+ \$329
Arm/Arms Textile Only		Two Arms	One Arm
Fabric/Vinyl Grade 1	FG1/VG1	+ \$0	+ \$0
COM	COM	+ \$21	+ \$11
Fabric/Vinyl Grade 2	FG2/VG2	+ \$21	+ \$11
Fabric/Vinyl Grade 3	FG3/VG3	+ \$62	+ \$31
Fabric/Vinyl Grade 4	FG4/VG4	+ \$103	+ \$52
Fabric/Vinyl Grade 5	FG5/VG5	+ \$154	+ \$77
Fabric/Vinyl Grade 6	FG6/VG6	+ \$226	+ \$113
Fabric/Vinyl Grade 7	FG7/VG7	+ \$318	+ \$159
Leather Grade 1	LG1	+ \$328	+ \$164
COL	COL	+ \$431	+ \$216
Leather Grade 2	LG2	+ \$431	+ \$216
Leather Grade 3	LG3	+ \$595	+ \$298

If different fabrics are selected for the seat and back, add the multiple upholstery upcharge as well, even if the fabrics are the same grade.

Please reference the [Textile Reference Guide](#) for pricing on fabric over grade 7 and leather over grade 3. Additional CAL 133 information can be found on [page 15](#).

CLUB CHAIR AND OTTOMAN

8. Options

Ganging Bracket	Code	Price
One Set of Ganging Brackets, Left-Attaching	XGVL	+ \$52
One Set of Ganging Brackets, Right-Attaching	XGVR	+ \$52
Two Sets of Ganging Brackets, One Set Left-Attaching and One Set Right-Attaching	XGV	+ \$103

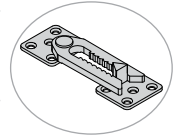

SPECIFICATIONS: WITH ARMS

Model:	VS FS8 Club Chair With 2 Upholstered Arms	VS FS11 / VS FS12 Club Chair With 1 Upholstered Arm
Dimensions		
Height	35"	35"
Width	28.5"	25.5"
Depth	29"	29"
Seat Width	22"	22"
Seat Depth	21"	21"
Seat Height	19.5"	19.5"
Back Height	17"	17"
Arm Height	26.5"	26.5"
Materials		
COM		
Fully Upholstered	5.4 yd	4.25 yd
Seat Only	1.9 yd	1.9 yd
Back Only	2.2 yd	2.2 yd
Arms Only	2.9 yd	1.75 yd
Side Only	N/A	N/A
Seat and Side Only	N/A	N/A
COL		
Fully Upholstered	83.3 sq ft	72 sq ft
Seat Only	29.4 sq ft	29.4 sq ft
Back Only	34.3 sq ft	34.3 sq ft
Arms Only	44.1 sq ft	26 sq ft
Side Only	N/A	N/A
Seat and Side Only	N/A	N/A
Weight and Capacity		
Weight	48 lb	43 lb
Weight Capacity	300 lb	300 lb
Warranty (Per Seat)		

Yardage requirements for COM and COL are for solid and non-directional fabrics. Additional material may be required for larger repeating patterns.

EFFECTIVE NOVEMBER 4, 2024 | GSA SIN #: 33721

SPECIFICATIONS: NO ARMS

Model:	VS Armless Club Chair	VS S1 Ottoman
Dimensions		
Height	35"	N/A
Width	22.5"	N/A
Depth	29"	N/A
Seat Width	22"	22"
Seat Depth	21"	21"
Seat Height	19.5"	17.5"
Back Height	17"	N/A
Arm Height	N/A	N/A
Materials		
COM		
Fully Upholstered	3.5 yd	1.88 yd
Seat Only	1.9 yd	N/A
Back Only	2.2 yd	N/A
Side Only	N/A	0.94 yd
Seat and Side Only	N/A	1.88 yd
COL		
Fully Upholstered	54.5 sq ft	29.4 sq ft
Seat Only	29.4 sq ft	N/A
Back Only	34.3 sq ft.	N/A
Side Only	N/A	14.7 sq ft
Seat and Side Only	N/A	29.4 sq ft
Weight and Capacity		
Weight	38 lb	28 lb
Weight Capacity	300 lb	300 lb
Warranty (Per Seat)		

Yardage requirements for COM and COL are for solid and non-directional fabrics. Additional material may be required for larger repeating patterns.



Club Chair With Arms

Tables and Desks

COFFEE TABLE | END TABLE
HEIGHT-ADJUSTABLE TABLE
MULTIPURPOSE TABLE
DESK AND RETURN

Statement of Line

COFFEE TABLE | END TABLE | CAFÉ TABLE | MULTIPURPOSE TABLE
HEIGHT-ADJUSTABLE TABLE | DESK AND RETURN

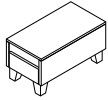

Mezzanine

Cube End Table | MCM TT1
Tapered Square Feet | LS1/LS12
[Page 443](#)

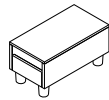

Mezzanine

Cube End Table | MCM TT1
Tapered Cylinder Feet | LS11
[Page 443](#)

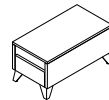

Mezzanine

Cube End Table | MCM TT1
Angular Feet | LS6
[Page 443](#)

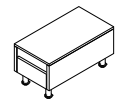

Mezzanine

Cube End Table | MCM TT1
Pole Feet | LS7/LS8
[Page 443](#)

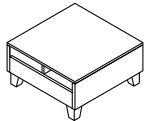

Mezzanine

Cube Coffee Table | MCM TT2
Tapered Square Feet | LS1/LS12
[Page 443](#)

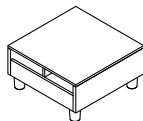

Mezzanine

Cube Coffee Table | MCM TT2
Tapered Cylinder Feet | LS11
[Page 443](#)

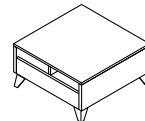

Mezzanine

Cube End Table | MCM TT2
Angular Feet | LS6
[Page 443](#)

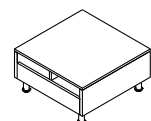

Mezzanine

Cube End Table | MCM TT2
Pole Feet | LS7/LS8
[Page 443](#)

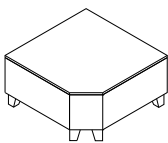

Mezzanine

Cube Coffee Table | MCM TT3
Tapered Square Feet | LS1/LS12
[Page 443](#)

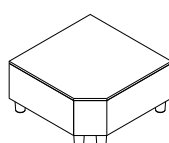

Mezzanine

Cube Coffee Table | MCM TT3
Tapered Cylinder Feet | LS11
[Page 443](#)

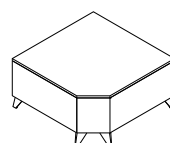

Mezzanine

Cube End Table | MCM TT3
Angular Feet | LS6
[Page 443](#)

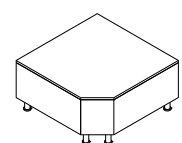

Mezzanine

Cube End Table | MCM TT3
Pole Feet | LS7/LS8
[Page 443](#)

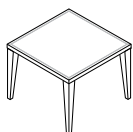

Mezzanine

Square Occasional Table | MZM TT8
Tapered Square Legs | LSL2
[Page 446](#)

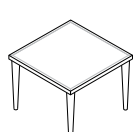

Mezzanine

Square Occasional Table | MZM TT8
Tapered Cylinder Legs | LSL3
[Page 446](#)

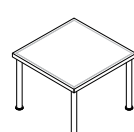

Mezzanine

Square Occasional Table | MZM TT8
Pole Legs | LSL1
[Page 446](#)



Mezzanine

Round Occasional Table | MZM TT6
Wood Tapered Square Legs | LSL2
[Page 446](#)

Statement of Line

COFFEE TABLE | END TABLE | CAFÉ TABLE | MULTIPURPOSE TABLE
HEIGHT-ADJUSTABLE TABLE | DESK AND RETURN



Mezzanine

Round Occasional Table | MZM TT6
Tapered Cylinder Legs | LSL3
Page 446

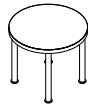

Mezzanine

Round Occasional Table | MZM TT6
Pole Legs | LSL1
Page 446

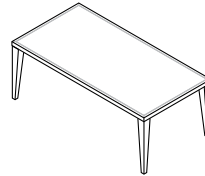

Mezzanine

Rectangular Occasional Table | MZM TT5
Tapered Square Legs | LSL2
Page 446

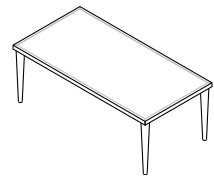

Mezzanine

Rectangular Occasional Table | MZM TT5
Tapered Cylinder Legs | LSL3
Page 446

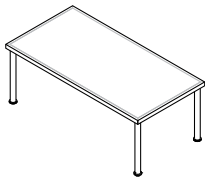

Mezzanine

Rectangular Occasional Table | MZM TT5
Tapered Square Legs | LSL1
Page 446

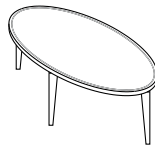

Mezzanine

Oval Occasional Table | MZM TT4
Tapered Square Legs | LSL2
Page 446

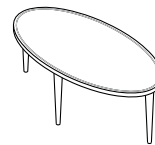

Mezzanine

Oval Occasional Table | MZM TT4
Tapered Cylinder Legs | LSL2
Page 446

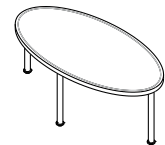

Mezzanine

Oval Occasional Table | MZM TT4
Pole Legs | LSL1
Page 446

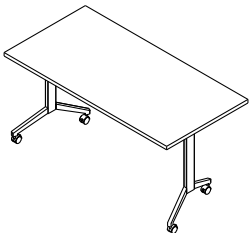

Ocala

Rectangular Top | 3061 TZ
Flip-Top Base | 3062 TBT2
Page 449

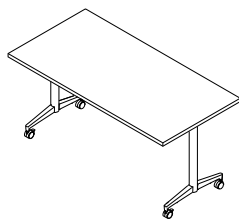

Parallon Training

Rectangular Tabletop | 3271 TZ
T-Leg Base | 3272 TBT2/TBT3
Page 457

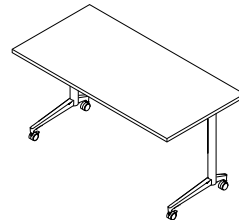

Parallon Training

Rectangular Tabletop | 3271 TZ
C-Leg Base | 3272 TBT3C Page 457

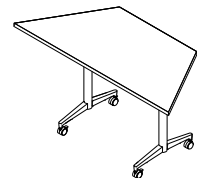

Parallon Training

Trapezoid Tabletop | 3271 TPZ
T-Leg Base | 3272 TBT2/TBT3
Page 457

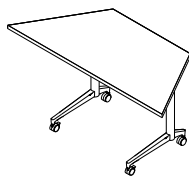

Parallon Training

Trapezoid Tabletop | 3271 TPZ
C-Leg Base | 3272 TBT3C
Page 457

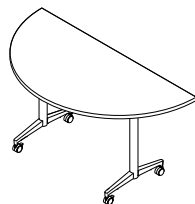

Parallon Training

Half-Round Tabletop | 3271 THR
T-Leg Base | 3272 TBT2/TBT3
Page 457

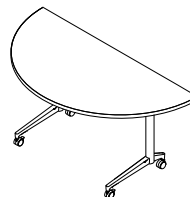

Parallon Training

Half-Round Tabletop | 3271 THR
C-Leg Base | 3272 TBT3C
Page 457

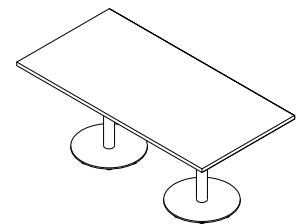

Parallon Meeting

Rectangular Tabletop | 3271 TZ
Standard-Height Dual-Disc Base |
3272 TH29 TBT16... Page 465

Statement of Line

COFFEE TABLE | END TABLE | CAFÉ TABLE | MULTIPURPOSE TABLE
HEIGHT-ADJUSTABLE TABLE | DESK AND RETURN

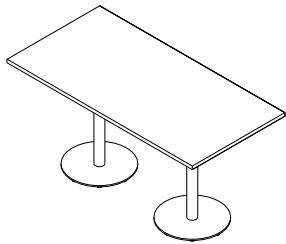

Parallon Meeting

Rectangular Tabletop | 3271 TZ
Counter-Height Dual-Disc Base |
3272 TH36 TBT16... [Page 465](#)

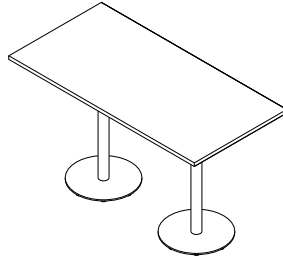

Parallon Meeting

Rectangular Tabletop | 3271 TZ
Bar-Height Dual-Disc Base |
3272 TH42 TBT16... [Page 465](#)

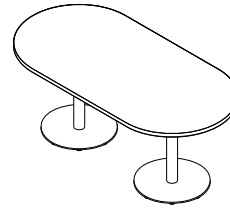

Parallon Meeting

Racetrack Tabletop | 3271 TK
Standard-Height Dual-Disc Base |
3272 TH29 TBT16... [Page 465](#)

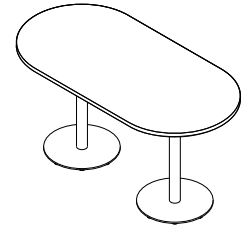

Parallon Meeting

Racetrack Tabletop | 3271 TK
Counter-Height Dual-Disc Base |
3272 TH36 TBT16... [Page 465](#)

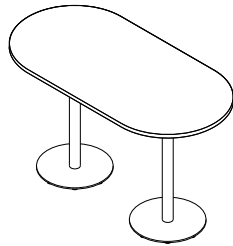

Parallon Meeting

Racetrack Tabletop | 3271 TK
Bar-Height Dual-Disc Base |
3272 TH42 TBT16... [Page 465](#)



Parallon Café

Square Tabletop | 3271 TS
Occasional-Height X-Base |
3272 TH16/TH20 TBT4 [Page 465](#)

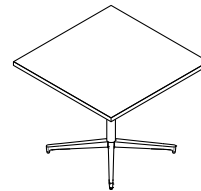

Parallon Café

Square Tabletop | 3271 TS
Standard-Height X-Base |
3272 TH29 TBT4..... [Page 465](#)

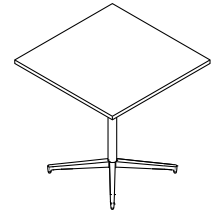

Parallon Café

Square Tabletop | 3271 TS
Counter-Height X-Base |
3272 TH36 TBT4..... [Page 465](#)

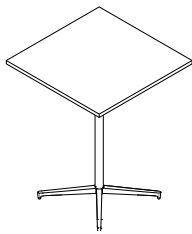

Parallon Café

Square Tabletop | 3271 TS
Bar-Height X-Base |
3272 TH42 TBT4..... [Page 465](#)

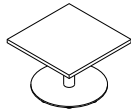

Parallon Café

Square Tabletop | 3271 TS
Occasional-Height Disc-Base |
3272 TH16/TH20 TBT15 [Page 465](#)

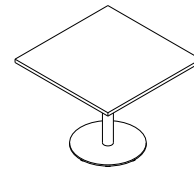

Parallon Café

Square Tabletop | 3271 TS
Standard-Height Disc-Base |
3272 TH29 TBT15... [Page 465](#)

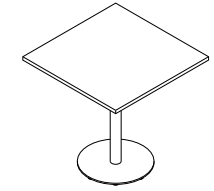

Parallon Café

Square Tabletop | 3271 TS
Counter-Height Disc-Base |
3272 TH36 TBT15... [Page 465](#)

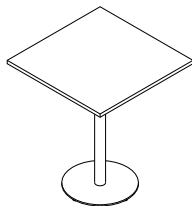

Parallon Café

Square Tabletop | 3271 TS
Bar-Height X-Base |
3272 TH42 TBT15... [Page 465](#)



Parallon Café

Round Tabletop | 3271 TR
Occasional-Height X-Base |
3272 TH16/TH20 TBT4 [Page 465](#)

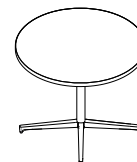

Parallon Café

Round Tabletop | 3271 TR
Standard-Height X-Base |
3272 TH29 TBT4..... [Page 465](#)



Parallon Café

Round Tabletop | 3271 TR
Counter-Height X-Base |
3272 TH36 TBT4..... [Page 465](#)

Statement of Line

COFFEE TABLE | END TABLE | CAFÉ TABLE | MULTIPURPOSE TABLE
HEIGHT-ADJUSTABLE TABLE | DESK AND RETURN

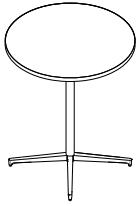

Parallon Café

Round Tabletop | 3271 TR
Bar-Height X-Base |
3272 TH42 TBT4..... [Page 465](#)

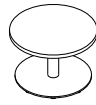

Parallon Café

Round Tabletop | 3271 TR
Occasional-Height Disc-Base |
3272 TH16/TH20 TBT15...[Page 465](#)

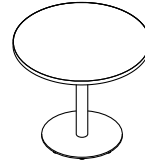

Parallon Café

Round Tabletop | 3271 TR
Standard-Height Disc-Base |
3272 TH29 TBT15... [Page 465](#)

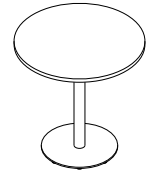

Parallon Café

Round Tabletop | 3271 TR
Counter-Height Disc-Base |
3272 TH36 TBT15... [Page 465](#)

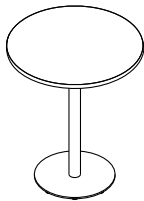

Parallon Café

Round Tabletop | 3271 TR
Bar-Height Disc-Base |
3272 TH42 TBT15... [Page 465](#)

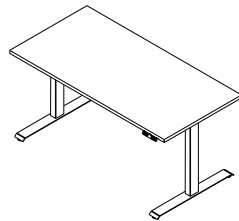

Surge

Rectangular Tabletop | 3301 TZ
2-Leg T-Leg | 3302 TBT6
[Page 470](#)

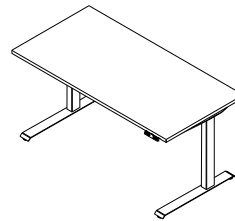

Surge

Rectangular Tabletop | 3301 TZ
2-Leg C-Leg | 3302 TBT6C
[Page 470](#)

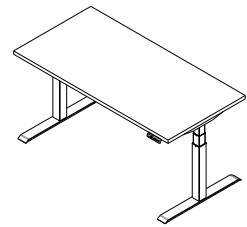

Switchback

Rectangular Tabletop | 3161 TZ
2-Leg T-Leg | 3162 TBT6/TBT7
[Page 480](#)

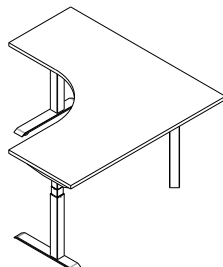

Switchback

90-Degree Tabletop | 3161 TBCR/TBCL
3-Leg C-Leg | 3162 TBT8C
[Page 488](#)

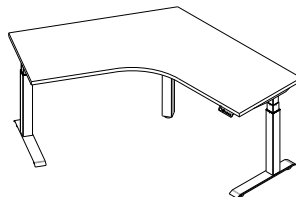

Switchback

120-Degree Tabletop | 3161 TA
3-Leg C-Leg | 3162 TBT8C
[Page 488](#)

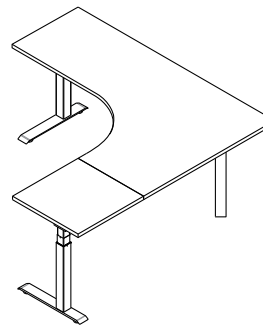

Switchback

Extended Left Corner | 3161 OL
C-Leg | 3162 TBT8C
[Page 488](#)

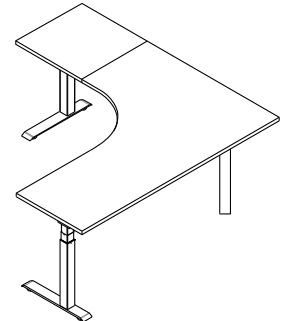

Switchback

Extended Right Corner | 3161 OR
C-Leg | 3162 TBT8C
[Page 488](#)

Statement of Line

COFFEE TABLE | END TABLE | CAFÉ TABLE | MULTIPURPOSE TABLE
HEIGHT-ADJUSTABLE TABLE | DESK AND RETURN

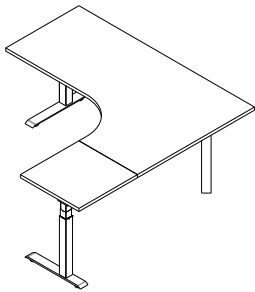

Switchback

Extended Offset Left Corner | 3161 OL
C-Leg | 3162 TBT8C
Page 488

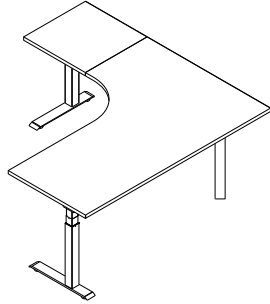

Switchback

Extended Offset Right Corner | 3162 OR
C-Leg | 3162 TBT8C
Page 488

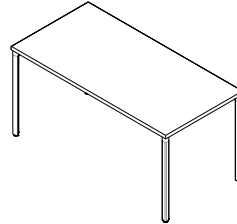

Tensor Multipurpose

Rectangular Tabletop | 3231 TZ
Table Base | 3232 TBT9
Page 506

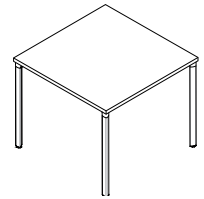

Tensor Café

Square Tabletop | 3231 TS
Table Base | 3232 TBT9
Page 502

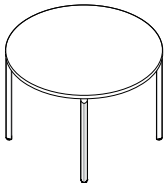

Tensor Café

Round Tabletop | 3231 TR
Table Base | 3232 TBT9
Page 502



Uni

Laptop Table
3260 TT9
Page 520

Mezzanine

END TABLE, COFFEE TABLE AND CORNER TABLE

Get in top shape.

Mezzanine® tables are available in two popular styles—cube and occasional. From the modernist cube to the transitional occasional style, these accent pieces are designed to complement any SitOnIt Seating chair, settee or sofa. Built with the highest quality veneers and hardwoods, Mezzanine tables are designed to withstand the repeated use required of high traffic lobbies and waiting areas. Add a finishing touch to any space with tables as distinctive as your seating.



Coffee Table
Featured with a Clear Maple finish

EFFECTIVE NOVEMBER 4, 2024

Featured Models

END TABLE :: \$1,157

End table, standard black plastic feet

COFFEE TABLE :: \$1,595

Coffee table, wood tapered square feet

CORNER TABLE :: \$1,871

Corner table, brushed aluminum pole feet

MEZZANINE

EFFECTIVE NOVEMBER 4, 2024 | GSA SIN #: 33721

Features

- Three functional cube designs
- Four finishes
- 10 foot/caster styles

1. Product

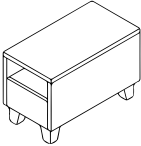
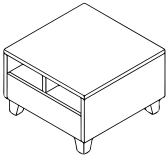
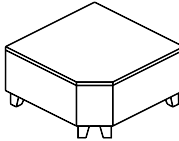
Table Type	Code	Price	
End Table	MCM TT1	\$1,157	
Coffee Table	MCM TT2	\$1,455	
Corner Table	MCM TT3	\$1,751	



End Table
Featured with a Medium Cherry finish

END TABLE, COFFEE TABLE AND CORNER TABLE

2. Appearance

Table Finish Color	Code	Price	
Clear Maple	FCW1	+ \$0	
Medium Cherry	FCW2	+ \$0	
Amber Mahogany	FCW3	+ \$0	
Espresso	FCW4	+ \$0	
Stain-to-Match	STM	+ \$70	

Stain-to-Match (STM) requires a one-time set up fee of \$275.

2. Feet

Foot Style and Color	Code	Price	
Feet			
Standard Plastic, Black	LS1	+ \$0	
Wood Tapered Square	LS12	+ \$140	
Wood Tapered Cylinder	LS11	+ \$140	
Metal Angular, Brushed Aluminum	LS6	+ \$120	
Metal 1.5" Pole, Brushed Aluminum	LS7	+ \$120	
Metal 1.5" Pole, Silver Powder Coat	LS8	+ \$120	
Casters			
Non-Locking Caster, Black	LS2	+ \$100	
Non-Locking Caster, Silver	LS3	+ \$100	
Locking Caster, Black	LS4	+ \$120	
Locking Caster, Silver	LS5	+ \$120	

EFFECTIVE NOVEMBER 4, 2024 | GSA SIN #: 33721

3. Options

Ganging Brackets	Code	Price
One Set, Left-Attaching	XGVL	+ \$52
One Set, Right-Attaching	XGVR	+ \$52
Two Sets, Left- and Right-Attaching	XGV	+ \$103

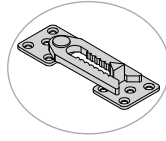

4. Packaging

Packaging	Code	Price
Knocked Down	P7	+ \$0

SPECIFICATIONS

Model:	MCM TT1 End Table	MCM TT2 Coffee Table	MCM TT3 Corner Table
Height	17"	17"	17"
Width	13.5"	25"	31.5"
Depth	25"	25"	31.5"
Weight	35 lb	52 lb	59 lb



Coffee Table
Featured with an Espresso finish

Mezzanine

OCCASIONAL TABLE

Get in top shape.

Mezzanine® tables are available in two popular styles—cube and occasional. From the modernist cube to the transitional occasional style, these accent pieces are designed to complement any chair, settee or sofa. Built with the highest quality veneers and hardwoods, Mezzanine tables are designed to withstand the repeated use required of high traffic lobbies and waiting areas. Add a finishing touch to any space with tables as distinctive as your seating.



Square Occasional Table

EFFECTIVE NOVEMBER 4, 2024

Featured Models

SQUARE :: \$1,594

Square occasional table, 21" tabletop, 24" high, wood tapered square legs

RECTANGULAR :: \$2,096

Rectangular occasional table, 48" tabletop, 24" high, wood tapered square legs





OVAL :: \$2,196

Oval occasional table, 48" tabletop, 18" high, brushed aluminum pole legs

Features

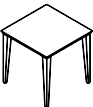
- Four occasional table shapes
- Three edge types
- Three leg styles
- Four wood stain finishes and stain-to-match program

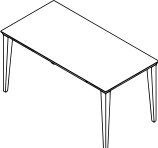
1. Product

Table Type	Code	Price	
Square Occasional Table	MZM TT8	\$1,534	
Round Occasional Table	MZM TT6	\$1,534	
Rectangular Occasional Table	MZM TT5	\$2,036	
Oval Occasional Table	MZM TT4	\$2,036	

2. Size

Table Top Size	Code	Price	
For Square and Round Tables			
21"	TZ21	+\$0	
24"	TZ24	+\$99	
36"	TZ36	+\$495	
For Rectangular and Oval Tables			
48"	TZ48	+\$0	
Table Height	Code	Price	
16"	TH16	+\$0	
18"	TH18	+\$20	
21"	TH21	+\$40	
24"	TH24	+\$60	

OCCASIONAL TABLES

3. Appearance

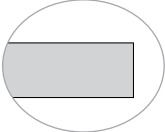
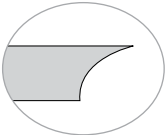
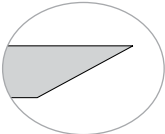
Table Top Edge Style	Code	Price	
Square	TE1	+\$0	
Bevel	TE2	+\$0	
Knife	TE3	+\$0	

Finish Color	Code	Price	
Clear Maple	FCW1	+\$0	
Medium Cherry	FCW2	+\$0	
Amber Mahogany	FCW3	+\$0	
Espresso	FCW4	+\$0	
Stain-to-Match	STM	+\$70	

Stain-to-Match (STM) requires a one-time set up fee of \$275.

4. Legs

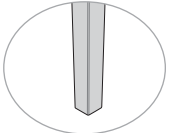
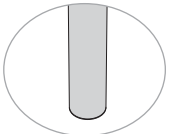
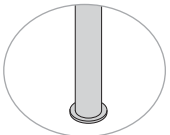
Leg Style	Code	Price	
Wood Tapered Square Leg	LSL2	+\$0	
Wood Tapered Cylinder Leg	LSL3	+\$0	
Metal 1.5" Pole, Brushed Aluminum Leg	LSL1	+\$140	

5. Options

Protection	Code	Price
Protective Wood Guard Clear Tape	LX1	+ \$84

Protective Wood Guard (LX1) is available on wood legs (LSL2/LSL3) only.

4. Packaging

Packaging	Code	Price
Knocked Down	P7	+ \$0

OCCASIONAL TABLES

SPECIFICATIONS

Model:	MZM TT8 Square Table		
	21"	24"	36"

Width	21"	24"	36"
-------	-----	-----	-----

Depth	21"	24"	36"
-------	-----	-----	-----

Weight	30 lb	34 lb	57 lb
--------	-------	-------	-------

Model:	MZM TT6 Round Table		
	21"	24"	36"

Width	21"	24"	36"
-------	-----	-----	-----

Depth	21"	24"	36"
-------	-----	-----	-----

Weight	27 lb	30 lb	48 lb
--------	-------	-------	-------

Model:	MZM TT5 Rectangular Table		
--------	---------------------------	--	--

Width	48"
-------	-----

Depth	24"
-------	-----

Weight	52 lb
--------	-------

Model:	MZM TT4 Oval Table		
--------	--------------------	--	--

Width	48"
-------	-----

Depth	24"
-------	-----

Weight	52 lb
--------	-------

Square, round, rectangular and oval tables are available in multiple heights.



Rectangular Occasional Table

Ocala

FLIP-TOP TABLES

Mighty and mobile.

The Ocala flip-top table is the simple yet sophisticated nesting table that solves all of your training and meeting room needs. Set-up takes just seconds—table surface flips and locks with the pull of a lever. The table nests for convenient, space-saving storage.



24" x 60"

Chair sold separately; see [page 267](#) for Movi.
Featured with a White laminate tabletop

EFFECTIVE NOVEMBER 4, 2024

Featured Models

24" x 60" :: \$946

24" x 60" top, grade 1 laminate, flip-top base, no grommets

30" x 72" :: \$1,106

30" x 72" top, grade 1 laminate, flip-top base, no grommets

Features

- Welded and bolted construction with steel end caps
- Multiple laminate options to fit your style
- Optional grommets for easy and clean setup of electronic devices
- Silver and white base finishes
- Casters are standard on all models
- 60", 66" and 72" top lengths
- 130 lb weight capacity warranty

SPECIFICATIONS

	3061 TBT2 Ocala Flip-Top Table
Height	28.59"
Height With Top Flipped Up	41.11"
Base Length	58.99"
Foot Length:	21.9"
Base Top Support Length:	52.84"
Distance Between Legs:	50.15"
Weight Capacity Warranty	130 lb

Height includes 1.125" tabletop and casters.

See the Stand-Alone Tabletop appendix on [page 623](#) for tabletop weights.

TABLETOP

TOPS AND BASES ARE SPECIFIED AND SOLD SEPARATELY.

1. Product

Product Type	Code	Price
Tabletop	3061 TBT2	Priced by Size

2. Finish

Laminate	Code	Price
Grade 1 Laminate		
Ankara Cherry	TL18	Priced by Size
Black	TL19	Priced by Size
Brazilian Walnut	TL20	Priced by Size
Cabinet Maple	TL21	Priced by Size
Driftwood	TL23	Priced by Size
Folkstone Grey	TL24	Priced by Size
Libretti	TL25	Priced by Size
Queenston Oak	TL26	Priced by Size
Sandalwood	TL27	Priced by Size
Walnut Amati	TL28	Priced by Size
White	TL29	Priced by Size
Grade 2 Laminate		
Classic Linen	TL17	Priced by Size
Colombian Walnut	TL55	Priced by Size
Crisp Linen	TL64	Priced by Size
Designer White	TL66	Priced by Size
Field Elm	TL13	Priced by Size
Frosty White	TL16	Priced by Size
Grey	TL62	Priced by Size
Grey Elm	TL51	Priced by Size
Kingswood Walnut	TL53	Priced by Size
Manitoba	TL56	Priced by Size
Neo Walnut	TL50	Priced by Size
Platinum	TL61	Priced by Size
Portico Teak	TL60	Priced by Size
Skyline Walnut	TL15	Priced by Size
Steel Mesh	TL59	Priced by Size
Tuscan Walnut	TL57	Priced by Size
Uptown Walnut	TL14	Priced by Size
Laminate Grade	Code	Price
Laminate Grade 1	GR1	Priced by Size
Laminate Grade 2	GR2	Priced by Size

EFFECTIVE NOVEMBER 4, 2024

TABLETOP

TOPS AND BASES ARE SPECIFIED AND SOLD SEPARATELY.

3. Shape

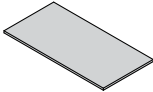
Product Type	Code	Price	
Rectangular Tabletop	TZ	Priced by Size	

4. Size

Tabletop Size (D x W)	Code	Price	
Rectangular Tabletop		Grade 1	Grade 2
24" x 60"	2460	\$324	\$486
24" x 66"	2466	\$358	\$537
24" x 72"	2472	\$389	\$584
30" x 60"	3060	\$404	\$606
30" x 66"	3066	\$445	\$668
30" x 72"	3072	\$484	\$726

5. Grommets

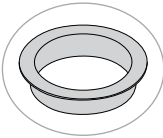
Grommet Location	Code	Price	
None	GP00	+ \$0	
Left	GP01	+ \$30	
Center	GP02	+ \$30	
Right	GP03	+ \$30	
Left and Center	GP04	+ \$60	
Left and Right	GP05	+ \$60	
Right and Center	GP06	+ \$60	
Left, Right and Center	GP07	+ \$90	
Grommet Color	Code	Price	
Black	GC01	+ \$0	
White	GC02	+ \$0	

EFFECTIVE NOVEMBER 4, 2024

1. Product

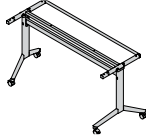
Product Type	Code	Price	
Flip-Top Base	3062 TBT2	\$622	

2. Finish

Paint Color	Code	Price
Silver	BF01	+ \$0
White	BF02	+ \$0

TABLE BASE

TOPS AND BASES ARE SPECIFIED AND SOLD SEPARATELY.

3. Matching Tabletop

Tabletop Shape	Code	Price
Matching Tabletop	TZ	+ \$0
Tabletop Size (D x W)	Code	Price
24" x 60"	TZ2460	+ \$0
24" x 66"	TZ2466	+ \$0
24" x 72"	TZ2472	+ \$0
30" x 60"	TZ3060	+ \$0
30" x 66"	TZ3066	+ \$0
30" x 72"	TZ3072	+ \$0

Bases require the specification of a tabletop size. Bases take their size from their corresponding tabletop.

1. Additional Options (Sold Separately)

Product Type	Code	Price	
Pair of Ganging Brackets	3159 XGV	\$50	



Featured with a Driftwood laminate tabletop

Parallon

TYPICALS

Everything to the table.

When you want cohesion in spaces large, small, shared or separate, there's Parallon. It's a single collection with a singular look, offering an array of choices for a variety of environments—and all the features to fit. Continue the cohesion even when it's time to “take five” from meeting or training. Our café + occasional tables help carry the design into your casual and touch-down spaces.



EFFECTIVE NOVEMBER 4, 2024

1. Collaborative Hexagon

Category	Code	Quantity	Description	List Price	Ext Price
Tabletop	3271 TBT3 GR1 TPZ 3060 GP00	6	Trapezoidal Tabletop: 30" x 60", Grade 1 Laminate, No Grommets	\$600	\$3,600
Table Base	3272 TBT3C TPZ 3060 LS18	6	Fixed Top C-Leg Base, Glides	\$515	\$3,090
Ganging	3159 XGV	3	Pair of Ganging Brackets	\$50	\$150

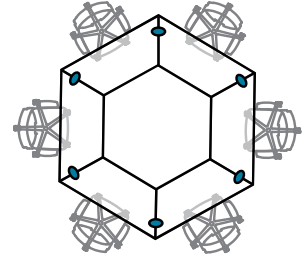

TOTAL: \$6,840

2. Small U-Shaped Training Space

Category	Code	Quantity	Description	List Price	Ext Price
Tabletop	3271 TBT3 GR1 TZ 3060 GP00	2	Rectangular Tabletop: 30" x 60", Grade 1 Laminate, No Grommets	\$404	\$808
Table Base	3272 TBT3 TZ 3060 TBT3C LS18	2	Fixed Top T-Leg Base, Glides (Pairs With 30" x 60" Rectangular Tabletop)	\$515	\$1,030
Tabletop	3271 TBT3 GR1 TPZ 3060 GP00	3	Trapezoidal Tabletop: 30" x 60", Grade 1 Laminate, No Grommets	\$600	\$1,800
Table Base	3272 TBT3 TPZ 3060 TBT3C LS18	3	Fixed Top T-Leg Base, Glides (Pairs With 30" x 60" Trapezoid Tabletop)	\$515	\$1,545
Ganging	3159 XGV	2	Pair of Ganging Brackets	\$50	\$100

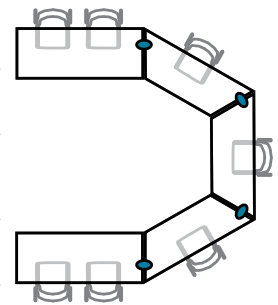

TOTAL: \$5,283

3. U-Shaped Training Space

Category	Code	Quantity	Description	List Price	Ext Price
Tabletop	3271 TBT2 GR1 TZ 3060 TE5 GP00	7	Rectangular Tabletop: 30" x 60", Grade 1 Laminate, No Grommets	\$404	\$2,828
Table Base	3260 TBT2 TZ 3072 LS18	7	Flip-Top T-Leg Base (Pairs With 30" x 60" Rectangular Tabletop)	\$753	\$5,271
Ganging	3159 XGV	6	Pair of Ganging Brackets	\$50	\$300

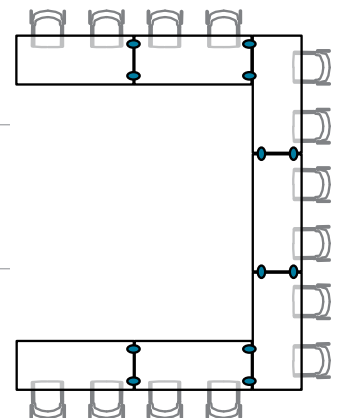

TOTAL: \$8,399

EFFECTIVE NOVEMBER 4, 2024

4. Collaborative Trapezoid Workstation

Category	Code	Quantity	Description	List Price	Ext Price
Tabletop	3271 TBT3 GR1 TPZ 3060 TE5 GP00	8	Trapezoidal Tabletop: 30" x 60", Grade 1 Laminate, No Grommets	\$600	\$4,800
Table Base	3272 TBT3 TPZ 3060 TBT3C LS18	8	Fixed Top T-Leg Base, Casters Pairs With 30" x 60" Trapezoid Tabletop	\$515	\$4,120
Ganging	3159 XGV	4	Pair of Ganging Brackets	\$50	\$200
TOTAL:					\$9,120

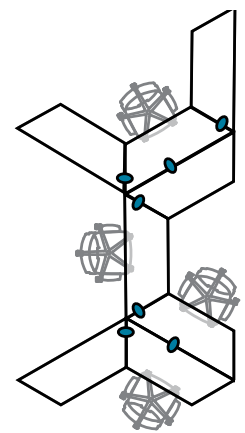

5. Classroom-Style, Individual Tables

Category	Code	Quantity	Description	List Price	Ext Price
Tabletop	3271 TBT2 GR2 TZ 3060 TE31 GP00	6	Rectangular Tabletop: 30" x 60", Grade 2 Laminate, Knife-Edged, No Grommets	\$728	\$4,368
Table Base	3272 TBT2 TZ 3060 LS18	6	Flip-Top T-Leg Base (Pairs With 30" x 60" Rectangular Tabletop)	\$753	\$4,518
TOTAL:					\$8,886

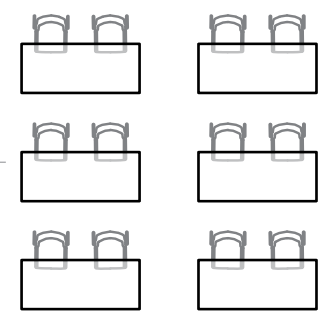

6. Classroom-Style, Rows

Category	Code	Quantity	Description	List Price	Ext Price
Tabletop	3271 TBT2 GR1 TZ 3060 TE5 GP00	6	Rectangular Tabletop: 30" x 60", Grade 1 Laminate, Flat-Edged No Grommets	\$404	\$2,424
Table Base	3272 TBT2C TZ 3060 LS18	6	Fixed-Top C-Leg Base, Casters (Pairs With 30" x 60" Rectangular Tabletop)	\$515	\$3,090
Ganging	3159 XGV	4	Pair of Ganging Brackets	\$50	\$200
TOTAL:					\$5,714

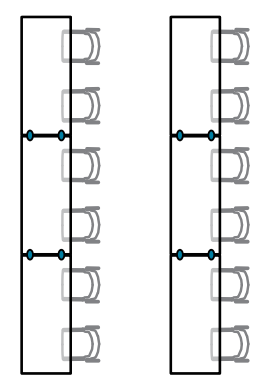

EFFECTIVE NOVEMBER 4, 2024

7. Reconfigurable Conference Table

Category	Code	Quantity	Description	List Price	Ext Price
Tabletop	3271 TBT2 GR1 TZ 3060 TL27 GP00	6	Rectangular Tabletop: 30" x 60", Flat-Edged Laminate, No Grommets	\$404	\$2,424
Table Base	3272 TBT2 TZ 3060 LS18	6	Flip-Top T-Leg Base (Pairs With 30" x 60" Rectangular Tabletop)	\$515	\$3,090
Ganging	3159 XGV	5	Pair of Ganging Brackets	\$50	\$250
TOTAL:				\$5,764	

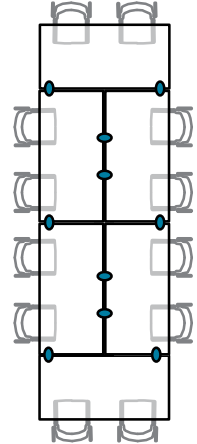

8. Impromptu Conference Table

Category	Code	Quantity	Description	List Price	Ext Price
Tabletop	3271 TBT3 GR1 TZ 3060 GP00	2	Rectangular Tabletop: 30" x 72", Grade 1 Laminate, No Grommets	\$484	\$968
Table Base	3272 TBT3 TZ 3060 TBT2 LS19	2	Fixed-Top T-Leg Base, Casters (Pairs With 30" x 72" Rectangular Tabletop)	\$515	\$1,030
Tabletop	3271 TBT3 GR1 THR 3060 GP00	2	Half-Round Tabletop: 30" x 60", Grade 1 Laminate, No Grommets	\$600	\$1,200
Table Base	3272 TBT3 TE5 THR 3060 LS19	2	Fixed-Top T-Leg Base, Casters (Pairs With 30" x 60" Half Round Tabletop)	\$515	\$1,030
Ganging	3159 XGV	3	Pair of Ganging Brackets	\$50	\$150
TOTAL:				\$4,378	

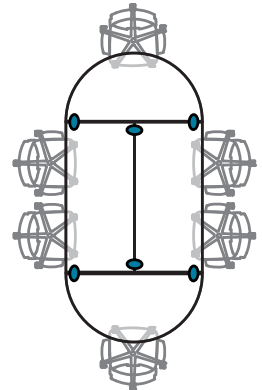

9. Collapsible Round

Category	Code	Quantity	Description	List Price	Ext Price
Tabletop	3271 TBT3 GR1 THR 3060 GP00	2	Half-Round Tabletop: 30" x 60", Grade 1 Laminate, No Grommets	\$600	\$1,200
Table Base	3272 TBT3 TE5 THR 3060 LS19	2	Flip-Top T-Leg Base, Casters (Pairs With 30" x 60" Half Round Tabletop)	\$753	\$1,506
Ganging	3159 XGV	1	Pair of Ganging Brackets	\$50	\$50
TOTAL:				\$2,756	

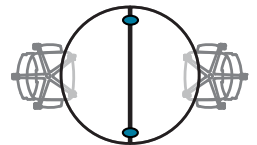

Parallon

FLIP-TOP AND FIXED TOP TRAINING TABLE

Everything to the table.

When you want cohesion in spaces large, small, shared or separate, there's Parallon. It's a single collection with a singular look, offering an array of choices for a variety of environments—and all the features to fit. Ensure design is never a distraction in the places where everyone needs to focus. Our Parallon line of training tables provides a unified and streamlined look from room to room.



30" x 60" Fixed Top
Featured with Chairs sold separately.
See [page 267](#) for *Movi*.

EFFECTIVE NOVEMBER 4, 2024

Featured Models

30" x 60" T-LEG :: \$919

30" x 60" tabletop, grade 1 laminate, fixed base, glides

30" x 60" C-LEG :: \$1,115

30" x 60" trapezoid tabletop, grade 1 laminate, C-leg fixed base, glides

30" x 60" FLIP-TOP :: \$1,157

30" x 60" rectangular tabletop, grade 1 laminate, flip-top base, casters

Features

- A broad yet curated collection that's easy to specify across countless applications
- Developed entirely in-house (from the ground up) to make space cohesion effortless
- Training or collaboration—enjoy a variety of table types, tops, bases and more
- Soft-close flip-top models with quick-release latches can nest, store and deploy easily
- Powder-coated metal finishes in black, white or silver
- An array of 28 laminate options; 11 Grade 1 and 17 Grade 2
- 300 lb weight capacity warranty
- Exceeds BIFMA requirements for safety.

1. Product

Product Type	Code	Price
Tabletop	3271	Priced by Size
Table Base	Code	Price
Flip-Top, T-Leg	TBT2	Priced by Size
Fixed Top, T-Leg	TBT3	Priced by Size
Fixed Top, C-Leg	TBT3C	Priced by Size

2. Tabletop Finish

Laminate Color	Code	Price
Grade 1 Laminate		
Ankara Cherry	TL18	Priced by Size
Black	TL19	Priced by Size
Brazilian Walnut	TL20	Priced by Size
Cabinet Maple	TL21	Priced by Size
Driftwood	TL23	Priced by Size
Folkstone Grey	TL24	Priced by Size
Libretti	TL25	Priced by Size
Queenston Oak	TL26	Priced by Size
Sandalwood	TL27	Priced by Size
Walnut Amati	TL28	Priced by Size
White	TL29	Priced by Size

FLIP-TOP AND TRAINING TABLETOP

TOPS AND BASES ARE SPECIFIED AND SOLD SEPARATELY.

2. Tabletop Finish

Laminate Color	Code	Price
Grade 2 (HPL) Laminates		
Classic Linen	TL17	Priced by Grade
Colombian Walnut	TL55	Priced by Grade
Crisp Linen	TL64	Priced by Grade
Designer White	TL66	Priced by Grade
Field Elm	TL13	Priced by Grade
Frosty White	TL16	Priced by Grade
Grey	TL62	Priced by Grade
Grey Elm	TL51	Priced by Grade
Kingswood Walnut	TL53	Priced by Grade
Manitoba	TL56	Priced by Grade
Neo Walnut	TL50	Priced by Grade
Platinum	TL61	Priced by Grade
Portico Teak	TL60	Priced by Grade
Skyline Walnut	TL15	Priced by Grade
Steel Mesh	TL59	Priced by Grade
Tuscan Walnut	TL57	Priced by Grade
Uptown Walnut	TL14	Priced by Grade
Laminate Grade	Code	Price
Grade 1	GR1	Priced by Size
Grade 2	GR2	Priced by Size

3. Shape

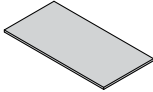
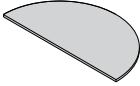
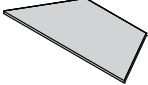
Tabletop Size	Code	Price	
Rectangular Tabletop	TZ	Priced by Size	
Half Round Tabletop	THR	Priced by Size	
Trapezoid Tabletop	TPZ	Priced by Size	

EFFECTIVE NOVEMBER 4, 2024

4. Edge

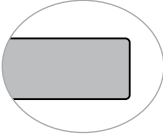
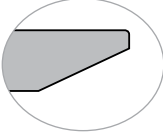
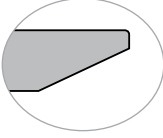
Edge Profile	Code	Price	
Flat Edge	TE5	Priced by Size	
Knife Edge, Front Only	TE31	Priced by Size	
Knife Edge, Front and Back	TE32	Priced by Size	

Knife edges are only available on grade 2 (GR2) laminate tabletops. Front and back knife edge option (TE5) is not available on half round (THR) tabletops.

5. Size

Tabletop Size	Code	Price		
Rectangular (D x W)		Grade 1 Flat Edge	Grade 2 Flat Edge	Grade 2 Knife Edge
18" x 42"	1842	\$176	\$264	\$317
18" x 48"	1848	\$200	\$300	\$360
18" x 54"	1854	\$225	\$338	\$406
18" x 60"	1860	\$248	\$372	\$447
18" x 66"	1866	\$275	\$413	\$496
18" x 72"	1872	\$300	\$450	\$540
24" x 42"	2442	\$229	\$344	\$413
24" x 48"	2448	\$261	\$392	\$471
24" x 54"	2454	\$292	\$438	\$526
24" x 60"	2460	\$324	\$486	\$584
24" x 66"	2466	\$358	\$537	\$645
24" x 72"	2472	\$389	\$584	\$701
30" x 42"	3042	\$285	\$428	\$514
30" x 48"	3048	\$324	\$486	\$584
30" x 54"	3054	\$366	\$549	\$659
30" x 60"	3060	\$404	\$606	\$728
30" x 66"	3066	\$445	\$668	\$802
30" x 72"	3072	\$484	\$726	\$872
36" x 42"	3642	\$540	\$810	\$972
36" x 48"	3648	\$570	\$855	\$1,026
36" x 54"	3654	\$625	\$938	\$1,126
36" x 60"	3660	\$700	\$1,050	\$1,260
36" x 66"	3666	\$790	\$1,185	\$1,422
36" x 72"	3672	\$800	\$1,200	\$1,440

FLIP-TOP AND TRAINING TABLETOP

TOPS AND BASES ARE SPECIFIED AND SOLD SEPARATELY.

5. Size (Cont.)

Tabletop Size	Code	Price		
Half Round		Grade 1 Flat Edge	Grade 2 Flat Edge	Grade 2 Knife Edge
24" x 48"	2448	\$340	\$510	\$612
30" x 60"	3060	\$600	\$900	\$1,080
Trapezoid		Grade 1 Flat Edge	Grade 2 Flat Edge	Grade 2 Knife Edge
24" x 48"	2448	\$340	\$510	\$612
30" x 60"	3060	\$600	\$900	\$1,080

36" (D) tabletops are not compatible with C-leg table bases.

6. Grommets

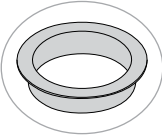
Grommet Location	Code	Price	
No Grommets	GP00	+ \$0	
Circular Grommets			
Left Only	GP01	+ \$30	
Center Only	GP02	+ \$30	
Right Only	GP03	+ \$30	
Left and Center	GP04	+ \$60	
Left and Right	GP05	+ \$60	
Right and Center	GP06	+ \$60	
Left, Right and Center	GP07	+ \$90	
Cutouts			
Precut for Parallon Power Accessory	GP08	+ \$30	
Grommet Color	Code	Price	
Black	GC01	+ \$0	
White	GC02	+ \$0	

Cutout option (GP08) is intended for use with a power unit. Corresponding grommet comes packaged with the power, which is sold separately. See [page 464](#) to purchase Parallon power accessories.

Circular grommets cannot be paired with power options.

EFFECTIVE NOVEMBER 4, 2024

1. Product

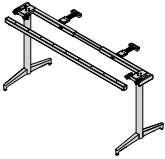
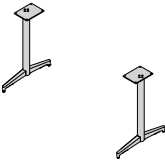
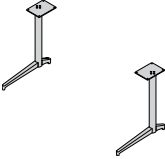
Product Type	Code	Price	
Table Base	3272	Priced by Base Style	
Base Style	Code	Price	
Flip-Top T	TBT2	\$753	
Fixed Top T	TBT3	\$515	
Fixed Top C	TBT3C	\$515	

2. Matching Tabletop

Tabletop Shape	Code	Price	
Half Round Tabletop	THR	+ \$0	
Rectangular Tabletop	TZ	+ \$0	
Trapezoid Tabletop	TPZ	+ \$0	

FLIP-TOP AND TRAINING TABLE BASE

TOPS AND BASES ARE SPECIFIED AND SOLD SEPARATELY.

2. Matching Tabletop

Tabletop Size	Code	Price	
Rectangular			
18" x 42"	1842	+ \$0	
18" x 48"	1848	+ \$0	
18" x 54"	1854	+ \$0	
18" x 60"	1860	+ \$0	
18" x 66"	1866	+ \$0	
18" x 72"	1872	+ \$0	
24" x 42"	2442	+ \$0	
24" x 48"	2448	+ \$0	
24" x 54"	2454	+ \$0	
24" x 60"	2460	+ \$0	
24" x 66"	2466	+ \$0	
24" x 72"	2472	+ \$0	
30" x 42"	3042	+ \$0	
30" x 48"	3048	+ \$0	
30" x 54"	3054	+ \$0	
30" x 60"	3060	+ \$0	
30" x 66"	3066	+ \$0	
30" x 72"	3072	+ \$0	
36" x 42"	3642	+ \$0	
36" x 48"	3648	+ \$0	
36" x 54"	3654	+ \$0	
36" x 60"	3660	+ \$0	
36" x 66"	3666	+ \$0	
36" x 72"	3672	+ \$0	
Half Round			
24" x 48"	2448	+ \$0	
30" x 60"	3060	+ \$0	
Trapezoid			
24" x 48"	2448	+ \$0	
30" x 60"	3060	+ \$0	

C-leg bases are not compatible with 36" deep tabletops.

EFFECTIVE NOVEMBER 4, 2024

3. Base Finish

Paint Color	Code	Price
Silver	BF01	+ \$0
White	BF02	+ \$0
Black	BF03	+ \$0

4. Feet

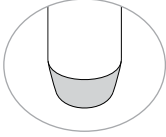
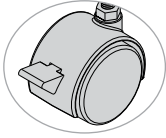
Foot Style	Code	Price	
Glides	LS18	+ \$0	
Casters	LS19	+ \$0	

Glide color will match base finish color. Casters (LS19) include two locking casters for the front feet and two non-locking casters for the back feet.



30" x 60" Flip-Top (Flipped and Nested)

FLIP-TOP AND TRAINING TABLE BASE

TOPS AND BASES ARE SPECIFIED AND SOLD SEPARATELY.

BASE SPECIFICATIONS

	Fixed T-Leg	Flip-Top T-Leg	Fixed C-Leg
Rectangular Tabletops			
18" x 42"	21.48 lb	30.92 lb	21.97 lb
18" x 48"	21.48 lb	36.04 lb	21.97 lb
18" x 54"	21.48 lb	36.69 lb	21.97 lb
18" x 60"	24.91 lb	37.54 lb	25.40 lb
18" x 66"	25.48 lb	38.19 lb	25.97 lb
18" x 72"	26.05 lb	39.04 lb	26.54 lb
24" x 42"	22.32 lb	31.98 lb	23.27 lb
24" x 48"	22.32 lb	37.10 lb	23.27 lb
24" x 54"	22.32 lb	37.75 lb	23.27 lb
24" x 60"	25.75 lb	38.60 lb	26.70 lb
24" x 66"	26.32 lb	39.25 lb	27.27 lb
24" x 72"	26.89 lb	40.10 lb	27.84 lb
30" x 42"	22.32 lb	32.12 lb	27.85 lb
30" x 48"	22.32 lb	37.24 lb	27.85 lb
30" x 54"	22.32 lb	37.89 lb	27.85 lb
30" x 60"	25.75 lb	38.74 lb	31.28 lb
30" x 66"	26.32 lb	39.39 lb	31.85 lb
30" x 72"	26.89 lb	40.24 lb	32.42 lb
36" x 42"	22.32 lb	32.12 lb	N/A
36" x 48"	22.32 lb	37.24 lb	N/A
36" x 54"	22.32 lb	37.89 lb	N/A
36" x 60"	25.75 lb	38.74 lb	N/A
36" x 66"	26.32 lb	39.39 lb	N/A
36" x 72"	26.89 lb	40.24 lb	N/A
Half Round Tabletops			
24" x 48"	21.48 lb	30.17 lb	21.97 lb
30" x 60"	22.32 lb	31.98 lb	23.27 lb
Trapezoid Tabletops			
24" x 48"	21.48 lb	29.42 lb	21.97 lb
30" x 60"	22.32 lb	31.23 lb	23.27 lb

See the Stand-Alone Tabletop appendix on page 469 for tabletop weights.

NESTED DIMENSIONS WITH 24" DEEP TABLETOP

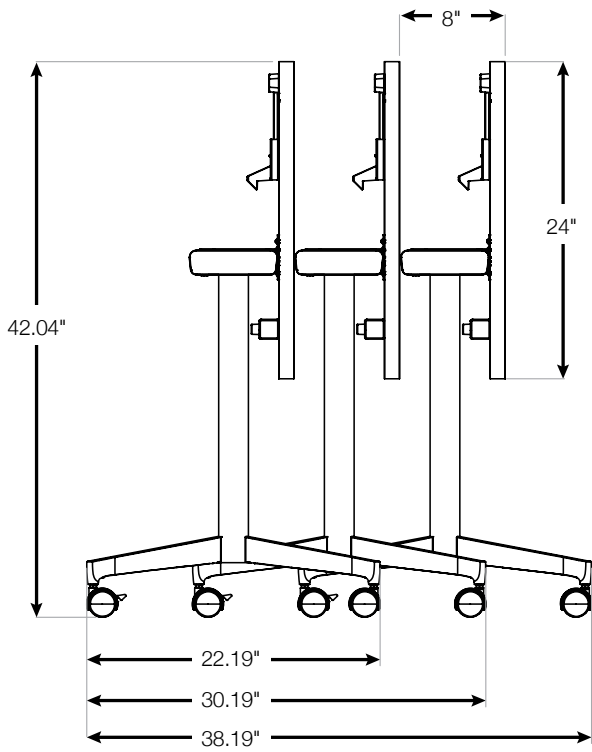

NESTED DIMENSIONS WITH 30" DEEP TABLETOP

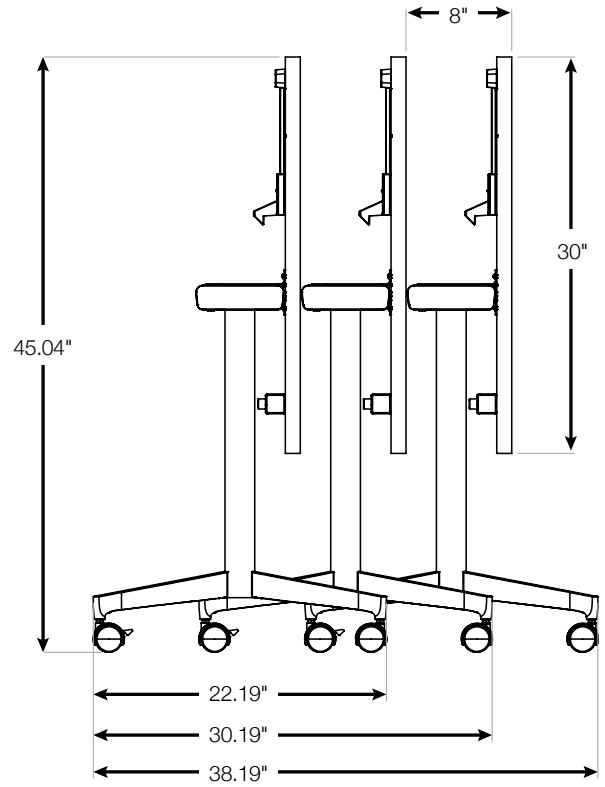

Features

- Daisy chain power and cable management will put a charge into any area
- Corded, hardwired daisy chain kit options: 5A/120V AC power receptacles and 2.1A/5V dual USB charging ports
- UL/ETL listed for US and Canada
- Hardwire power (4-circuit) for more demanding applications: 8 wire 4 circuit (3+1) system, single-sided quad power blocks, 4-15A/120V AC simplex receptacles, 4 data knockouts for RJ45 connectors -
- ETL listed for US and Canada.

1. Standalone Power Kit

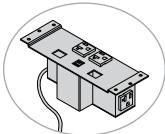
Product Type	Code	Price	
Standalone 3-Prong Infeed	3131 PV1 SA1	\$513	
Power Type	Code	Price	
2AC, Dual USB, 2 Data	PT8	+ \$0	
Power Color	Code	Price	
Silver	PC2	+ \$0	

ACCESSORIES AND POWER

EACH PRODUCT SOLD SEPARATELY.

1. Daisy Chain Power

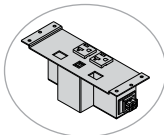
Daisy Chain Power Kit	Code	Price	
Single Quick Kit	3131 PV1 Q1	\$652	
Table Length	Code	Price	
48"	DL48	+ \$0	
60"	DL60	+ \$21	
72"	DL72	+ \$42	
Power Type	Code	Price	
2AC, Dual USB, 2 Data	PT8	+ \$0	
Power Color	Code	Price	
Silver	PC2	+ \$0	

2. Daisy Chain Power Infeed

Product Type	Code	Price	
Power Infeed	3131 PV1 IF	Priced by Style	
Product Style	Code	Price	
Hardwire, 72"	HWC72	+ \$160	
20-Amp, 3-Prong, 72"	TPC72	+ \$244	

Maximum of 9 tables per infeed.

EFFECTIVE NOVEMBER 4, 2024

1. Hardwire Power

Power Style	Code	Price	
4-Circuit, Single Sided, Power and Data Ready	3132 PS1 SB1 PT7	\$369	
Power Color	Code	Price	
Black	PC1	+ \$0	

2. Hardwire Power Linking Cables

Linking Cables	Code	Price	
8-Wire, 4-Circuit Interconnect Cables	3132 PS1 IC	Priced by Style	
Length (IC Only)	Code	Price	
42" for 48" Tabletops	IC42	\$130	
54" for 60" Tabletops	IC54	\$167	
66" for 72" Tabletops	IC66	\$205	

3. Hardwire Power Infeed

Product Style	Code	Price	
Hardwire Power Infeed, 72"	3132 PS1 IF HWC72	\$221	

Maximum of 5 linked tables per circuit. Maximum of 20 linked tables if all 4 circuits are used.

1. Wire Management

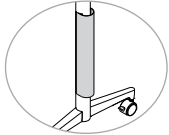
Product Type	Code	Price	
Vertical Wire Leg Cover	3279 WM07	\$56	
Paint Color	Code	Price	
Silver	WMC01	\$0	
White	WMC02	\$0	
Black	WMC03	\$0	

1. Other Accessories

Ganging	Code	Price	
Pair of Ganging Brackets	3159 XGV	\$50	

ACCESSORIES AND POWER

EACH PRODUCT SOLD SEPARATELY.

NUMBER OF GANGING BRACKET LOCATIONS

	Flat Edge	Knife Edge (Front Only)	Knife Edge (Front and Back)
T-Leg Flip-Top Rectangle			
18" (D) x 42"-66" (W)	10	6	2
18" (D) x 72" (W)	8	6	2
24" Deep	10	6	2
30" Deep	12	8	4
36" Deep	12	8	4
T-Leg Fixed-Top Rectangle			
18" Deep	12	8	4
24" Deep	10	6	2
30" Deep	12	8	4
36" Deep	12	8	4
C-Leg Fixed-Top Rectangle			
18" Deep	8	4	2
24" Deep	8	4	2
30" Deep	12	8	4
T-Leg Flip-Top Half Round			
24" Deep	6	4	4
30" Deep	6	4	4
T-Leg Fixed-Top Half Round			
24" Deep	6	4	4
30" Deep	6	4	4
C-Leg Fixed-Top Half Round			
24" Deep	6	4	4
30" Deep	6	4	4
T-Leg Flip-Top Trapezoid			
24" Deep	6	4	4
30" Deep	6	4	4
T-Leg Fixed-Top Trapezoid			
24" Deep	6	4	4
30" Deep	6	4	4
C-Leg Fixed-Top Trapezoid			
24" Deep	6	4	4
30" Deep	6	4	4

Parallon

MEETING, CAFÉ AND OCCASIONAL TABLE

Everything to the table.

When you want cohesion in spaces large, small, shared or separate, there's Parallon. It's a single collection with a singular look, offering an array of choices for a variety of environments—and all the features to fit. Continue the cohesion even when it's time to “take five” from meeting or training. Our café + occasional tables help carry the design into your casual and touch-down spaces.



Meeting Table
Chairs sold separately. See [page 90](#) for Hexy.

EFFECTIVE NOVEMBER 4, 2024

Featured Models

MEETING :: \$1,868

36" x 72" rectangular laminate tabletop, dual disc base, 29" column height, grade 1 laminate

CAFÉ :: \$987

36" square laminate tabletop, grade 1 laminate, 42" column height, disc-base

OCCASIONAL :: \$603

24" round laminate tabletop, grade 1 laminate, 16" column height, x-base,

Features

- A broad yet curated collection that's easy to specify across countless applications
- Developed entirely in-house (from the ground up) to make space cohesion effortless
- Meeting, café or occasional—enjoy a variety of table types, tops, bases and more
- Five column height choices
- Powder-coated metal finishes in black, white or silver
- Universal built-in desktop power fits all outlet types, including AC, USB-A and USB-C
- An array of 28 laminate options; 11 Grade 1 and 17 Grade 2
- 300 lb weight capacity warranty
- Exceeds BIFMA requirements for safety

1. Product

Product Type	Code	Price
Tabletop	3271	Priced by Size
Pairs With	Code	Price
X-Base Café/Occasional	TBT4	Priced by Size
X-Base Power Ready	TBT4P	Priced by Size
Disc-Base	TBT15	Priced by Size
Disc Base Power Ready	TBT15P	Priced by Size
Dual Disc-Base	TBT16	Priced by Size
Dual Disc Base Power Ready	TBT16P	Priced by Size

2. Tabletop Finish

Laminate Color	Code	Price
Grade 1 Laminate		
Ankara Cherry	TL18	Priced by Grade
Black	TL19	Priced by Grade
Brazilian Walnut	TL20	Priced by Grade
Cabinet Maple	TL21	Priced by Grade
Driftwood	TL23	Priced by Grade
Folkstone Grey	TL24	Priced by Grade
Libretti	TL25	Priced by Grade
Queenston Oak	TL26	Priced by Grade
Sandalwood	TL27	Priced by Grade
Walnut Amati	TL28	Priced by Grade
White	TL29	Priced by Grade
Grade 2 Laminate		
Classic Linen	TL17	Priced by Grade
Colombian Walnut	TL55	Priced by Grade
Crisp Linen	TL64	Priced by Grade
Designer White	TL66	Priced by Grade
Field Elm	TL13	Priced by Grade
Frosty White	TL16	Priced by Grade
Grey	TL62	Priced by Grade
Grey Elm	TL51	Priced by Grade
Kingswood Walnut	TL53	Priced by Grade
Manitoba	TL56	Priced by Grade
Neo Walnut	TL50	Priced by Grade
Platinum	TL61	Priced by Grade
Portico Teak	TL60	Priced by Grade
Skyline Walnut	TL15	Priced by Grade
Steel Mesh	TL59	Priced by Grade
Tuscan Walnut	TL57	Priced by Grade
Uptown Walnut	TL14	Priced by Grade
Laminate Grade	Code	Price
Laminate Grade 1	GR1	Priced by Size
Laminate Grade 2	GR2	Priced by Size

EFFECTIVE NOVEMBER 4, 2024

MEETING, CAFÉ AND OCCASIONAL TABLETOP
TOPS AND BASES ARE SPECIFIED AND SOLD SEPARATELY.

3. Shape

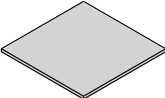
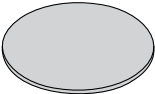
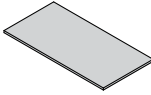
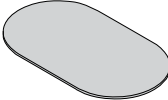
Tabletop Shape	Code	Price	
Square	TS	Priced by Size	
Round	TR	Priced by Size	
Rectangular	TZ	Priced by Size	
Racetrack	TK	Priced by Size	

Actual size of 30" x 30" tabletop is 30.75" x 30.75".

4. Edge

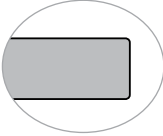
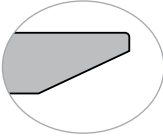
Edge Profile	Code	Price	
Flat Edge	TE5	+ \$0	
Knife Edge, All Sides	TE3	+ \$0	

Knife edges are only available on grade 2 (GR2) laminate tabletops.

5. Size

Tabletop Size	Code	Laminate Price		
Occasional and Café (Square or Round)		Grade 1 Flat Edge	Grade 2 Flat Edge	Grade 2 Knife Edge
24"	2424	\$287	\$431	\$517
30"	3030	\$331	\$497	\$596
36"	3636	\$383	\$575	\$690
42"	4242	\$400	\$600	\$720
48"	4848	\$458	\$687	\$825
54"	5454	\$800	\$1,200	\$1,440
60"	6060	\$1,200	\$1,800	\$2,160
Meeting (Rectangular or Racetrack)		Grade 1 Flat Edge	Grade 2 Flat Edge	Grade 2 Knife Edge
24" x 60"	2460	\$324	\$486	\$584
30" x 72"	3072	\$484	\$726	\$872
30" x 84"	3084	\$565	\$848	\$1,018
30" x 96"	3096	\$850	\$1,275	\$1,530
36" x 72"	3672	\$800	\$1,200	\$1,440
36" x 84"	3684	\$875	\$1,313	\$1,576
36" x 96"	3696	\$950	\$1,425	\$1,710

Actual size of 30" x 30" tabletop is 30.75" x 30.75".

Disc base is not available with 54" and 60" tabletops. 16", 20", and 42" tall columns are not compatible with 54" and 60" tabletops.

6. Edge

Grommet/Power Location (Power-Ready Models Only)	Code	Price	
Round and Square Tabletop			
Center Only	TE5	+ \$30	
Racetrack and Rectangular Tabletop			
Left Only	TE5	+ \$30	
Right Only	TE5	+ \$30	
Left and Right	TE5	+ \$60	

EFFECTIVE NOVEMBER 4, 2024

1. Product

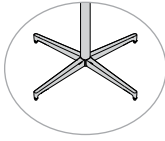
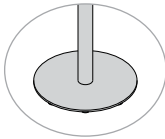
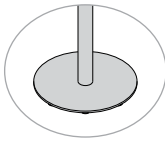
Product Type	Code	Price	
Table Base	3272	Priced by Column Height	
Base Style	Code	Price	
Round and Square Tabletops			
X-Base	TBT4	\$356	
X-Base Power Ready	TBT4P	\$496	
Disc-Base	TBT15	\$534	
Disc Base Power Ready	TBT15P	\$674	
Racetrack and Rectangular Tabletops			
Dual Disc-Base	TBT16	\$1,068	
Dual Disc Base Power Ready	TBT16P	\$1,348	

Power module (PT111) must be ordered separately.

2. Base Finish

Paint Color	Code	Price	
Silver	BF01	+ \$0	
White	BF02	+ \$0	
Black	BF03	+ \$0	

3. Power

Standalone Power Unit	Code	Price	
1AC-1USBA-1USBC Outlet With 8 Foot Cable	PT111	+ \$335	
Power Color	Code	Price	
Black	PC1	+ \$0	
White	PC4	+ \$0	

MEETING, CAFÉ AND OCCASIONAL TABLETOP TOPS AND BASES ARE SPECIFIED AND SOLD SEPARATELY.

4. Matching Tabletop

Table Top Size	Code	Price	
Occasional and Café (Square or Round)			
24"	2424	+ \$0	
30"	3030	+ \$0	
36"	3636	+ \$0	
42"	4242	+ \$0	
48"	4848	+ \$0	
54"	5454	+ \$0	
60"	6060	+ \$0	
Meeting (Rectangular or Racetrack)			
24" x 60"	2460	+ \$0	
30" x 72"	3072	+ \$0	
30" x 84"	3084	+ \$0	
30" x 96"	3096	+ \$0	
36" x 72"	3672	+ \$0	
36" x 84"	3684	+ \$0	
36" x 96"	3696	+ \$0	

Table bases require the specification of a tabletop size. Bases take their size from their corresponding top size.

Disc base is not available with 54" and 60" tabletops. 16", 20" and 42" height columns are not compatible with 54" and 60" tabletops.

5. Height

Column Height	Code	Price	
Occasional (Square or Round)			
16"	TH16	- \$40	
20"	TH20	- \$30	
Café (Square or Round)			
29"	TH29	+ \$0	
36"	TH36	+ \$55	
42"	TH42	+ \$70	
Meeting (Rectangular or Racetrack)			
29"	TH29	+ \$0	
36"	TH36	+ \$110	
42"	TH42	+ \$140	

6. Feet

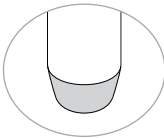
Foot Style	Code	Price	
Glides	LS18	+ \$0	

Glide color will match base finish color.

SPECIFICATIONS: WEIGHT

Table Depth	X-Base	Disc-Base
Square Tabletop		
24" x 16" (H)	15.35 lb	78.25 lb
24" x 20" (H)	16.25 lb	79.47 lb
24" x 29" (H)	18.26 lb	80.95 lb
24" x 36" (H)	19.85 lb	84.33 lb
24" x 42" (H)	21.20 lb	84.90 lb
30" x 16" (H)	17.95 lb	78.25 lb
30" x 20" (H)	18.85 lb	79.47 lb
30" x 29" (H)	20.86 lb	80.95 lb
30" x 36" (H)	22.45 lb	84.33 lb
30" x 42" (H)	23.80 lb	84.90 lb
36" x 16" (H)	17.95 lb	78.25 lb
36" x 20" (H)	18.85 lb	79.47 lb
36" x 29" (H)	20.86 lb	80.95 lb
36" x 36" (H)	22.45 lb	84.33 lb
36" x 42" (H)	23.80 lb	84.90 lb
42" x 16" (H)	19.19 lb	78.25 lb
42" x 20" (H)	20.09 lb	79.47 lb
42" x 29" (H)	22.10 lb	80.95 lb
42" x 36" (H)	23.69 lb	84.33 lb
42" x 42" (H)	25.04 lb	84.90 lb
48" x 16" (H)	19.19 lb	78.25 lb
48" x 20" (H)	20.09 lb	79.47 lb
48" x 29" (H)	22.10 lb	80.95 lb
48" x 36" (H)	23.69 lb	84.33 lb
48" x 42" (H)	25.04 lb	84.90 lb
54" x 29" (H)	22.10 lb	80.95 lb
54" x 36" (H)	23.69 lb	84.33 lb
60" x 29" (H)	22.10 lb	80.95 lb
60" x 36" (H)	23.69 lb	84.33 lb
Round Tabletop		
24" x 16" (H)	15.35 lb	52.92 lb
24" x 20" (H)	16.25 lb	54.14 lb
24" x 29" (H)	18.26 lb	55.62 lb
24" x 36" (H)	19.85 lb	59 lb
24" x 42" (H)	21.2 lb	59.57 lb
30" x 16" (H)	15.35 lb	52.92 lb
30" x 20" (H)	16.25 lb	54.14 lb
30" x 29" (H)	18.26 lb	55.62 lb
30" x 36" (H)	19.85 lb	59 lb
30" x 42" (H)	21.2 lb	59.57 lb
36" x 16" (H)	17.95 lb	52.92 lb
36" x 20" (H)	18.85 lb	54.14 lb
36" x 29" (H)	20.86 lb	55.62 lb
36" x 36" (H)	22.45 lb	59 lb
36" x 42" (H)	23.8 lb	59.57 lb
42" x 16" (H)	19.19 lb	52.92 lb
42" x 20" (H)	20.09 lb	54.14 lb
42" x 29" (H)	22.1 lb	55.62 lb
42" x 36" (H)	23.69 lb	59 lb
42" x 42" (H)	25.04 lb	59.57 lb
48" x 16" (H)	19.19 lb	52.92 lb
48" x 20" (H)	20.09 lb	54.14 lb
48" x 29" (H)	22.1 lb	55.62 lb
48" x 36" (H)	23.69 lb	59 lb
48" x 42" (H)	25.04 lb	59.57 lb
54" x 29" (H)	22.1 lb	55.62 lb
54" x 36" (H)	23.69 lb	59 lb
60" x 29" (H)	22.1 lb	55.62 lb
60" x 36" (H)	23.69 lb	59 lb

MEETING, CAFÉ AND OCCASIONAL TABLETOP TOPS AND BASES ARE SPECIFIED AND SOLD SEPARATELY.

SPECIFICATIONS: WEIGHT

Table Depth	Disc-Base
Rectangular Tabletop	
24" x 29" (H)	161.90 lb
24" x 36" (H)	168.66 lb
24" x 42" (H)	169.80 lb
30" x 29" (H)	161.90 lb
30" x 36" (H)	168.66 lb
30" x 42" (H)	169.80 lb
36" x 29" (H)	161.90 lb
36" x 36" (H)	168.66 lb
36" x 42" (H)	169.80 lb
Racetrack Tabletop	
24" x 29" (H)	111.24 lb
24" x 36" (H)	118.00 lb
24" x 42" (H)	119.14 lb
30" x 29" (H)	111.24 lb
30" x 36" (H)	118.00 lb
30" x 42" (H)	119.14 lb
36" x 29" (H)	111.24 lb
36" x 36" (H)	118.00 lb
36" x 42" (H)	119.14 lb

See the Stand-Alone Tabletop appendix on page 469 for tabletop weights.

SPECIFICATIONS: DIMENSIONS

Table Depth	X-Base	Disc-Base	Dual Disc
	Diagonal Footprint	Base Diameter	Base Diameter
24"	22.58"	21.00"	21.00"
30"	22.58"	21.00"	21.00"
36"	34.08"	21.00"	21.00"
42"	38.08"	27.00"	
48"	38.08"	27.00"	
54"	38.08"		
60"	38.08"		
	Column Diameter		
	2.25"	3"	3"
	Disc Base Thickness		
		0.39"	

Surge

2-LEG HEIGHT-ADJUSTABLE TABLE

Well-made wellness.

Add elevated design and sound ergonomics to any workspace with our Surge height-adjustable table. Its rugged dual-beam base is one of the quickest to assemble in the industry and can take on extra weight, giving you more tabletop options — all while providing peace of mind with enhanced safety features, including meeting BIFMA X5.5 standards.



24" x 60"
Featured with a Queenston Oak laminate tabletop

EFFECTIVE NOVEMBER 4, 2024

Featured Models

2-STAGE T-LEG :: \$1,108

2-Stage T-leg base, 24" x 60" laminate top, grade 1 laminate, no grommets, glides

2-STAGE T-LEG :: \$1,188

2-Stage T-leg base, 30" x 60" laminate top, grade 1 laminate, no grommets, glides

Features

- Support healthy working postures, whether seated or standing
- Surge offers a height range of 26.9"–46.6" (excluding top)
- Weight capacity warranty, including worksurface: Rated load is 250 lb at 10,000 cycles; maximum load is 265 lb
- Quick installation features an enhanced and exclusive locking mechanism
- Advanced anti-collision Sensor stops (and retracts) the table upon contact with any objects
- LED height display and push-button controls offer three user-customizable positions
- Available with T-leg and C-leg on adjustable glides
- 28 different durable laminate options to fit your style
- Three durable powder-coated metal finishes in silver, black or white
- Adjustment speed: 1.4 inches per second
- Operational noise level: approximately 48 dB (not including ambient noise)
- UL Certified and meets BIFMA X5.5 Certification

SPECIFICATIONS

Model:	3301/3302 TBT6/TBT6C
Dimensions	
Min and Max Height (Base Only)	26.9"–46.6"
Min and Max Height (With Table Top)	28"–47.7"
Foot Length With 23", 24" Tabletop Depth	22.72"
Foot Length With 29", 30" Tabletop Depth	28.62"
Tabletop Thickness	1.125"
Adjustment Speed	1.4 Inches Per Second
Number of Crossbar	2
Standby Power Consumption	2.6W
Noise	Approximately 48 DB (Not Including Ambient Noise)
Power Cord Lengths	106"
Rated Load Weight Capacity Warranty (Incl. Worksurface)	250 lb at 10,000 Cycles
Maximum Load Capacity (Incl. Worksurface)	265 lb

TABLETOP

1. Tabletop

Product Type	Code	Price	
Height-Adjustable Table	3301	Priced by Size	
Product Style	Code	Price	
2-Stage T-Leg Base	TBT6	Priced by Size	
2-Stage C-Leg Base	TBT6C	Priced by Size	
Laminate	Code	Price	
Grade 1			
Ankara Cherry	TL18	Priced by Size	
Black	TL19	Priced by Size	
Brazilian Walnut	TL20	Priced by Size	
Cabinet Maple	TL21	Priced by Size	
Driftwood	TL23	Priced by Size	
Folkstone Grey	TL24	Priced by Size	
Libretti	TL25	Priced by Size	
Queenston Oak	TL26	Priced by Size	
Sandalwood	TL27	Priced by Size	
Walnut Amati	TL28	Priced by Size	
White	TL29	Priced by Size	
Laminate	Code	Price	
Grade 2			
Classic Linen	TL17	Priced by Size	
Colombian Walnut	TL55	Priced by Size	
Crisp Linen	TL64	Priced by Size	
Designer White	TL66	Priced by Size	
Field Elm	TL13	Priced by Size	
Frosty White	TL16	Priced by Size	
Grey	TL62	Priced by Size	
Grey Elm	TL51	Priced by Size	
Kingswood Walnut	TL53	Priced by Size	
Manitoba	TL56	Priced by Size	
Neo Walnut	TL50	Priced by Size	
Platinum	TL61	Priced by Size	
Portico Teak	TL60	Priced by Size	
Skyline Walnut	TL15	Priced by Size	
Steel Mesh	TL59	Priced by Size	
Tuscan Walnut	TL57	Priced by Size	
Uptown Walnut	TL14	Priced by Size	
Laminate Grade	Code	Price	
Laminate Grade 1	GR1	Priced by Size	
Laminate Grade 2	GR2	Priced by Size	

1. Tabletop (Cont.)

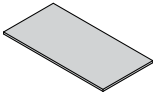
Tabletop Shape	Code	Price	
Rectangular	TZ	Priced by Size	

Tabletop Size	Code	Laminate Price	
		Grade 1	Grade 2
Rectangular (D x W)			
23" x 46"	TZ2346	\$261	\$392
23" x 52"	TZ2352	\$292	\$438
23" x 58"	TZ2358	\$324	\$486
23" x 64"	TZ2364	\$358	\$537
23" x 70"	TZ2370	\$389	\$584
23" x 76"	TZ2376	\$421	\$632
23" x 82"	TZ2382	\$453	\$680
24" x 42"	TZ2442	\$229	\$344
24" x 48"	TZ2448	\$261	\$392
24" x 54"	TZ2454	\$292	\$438
24" x 60"	TZ2460	\$324	\$486
24" x 66"	TZ2466	\$358	\$537
24" x 72"	TZ2472	\$389	\$584
24" x 78"	TZ2478	\$421	\$632
24" x 84"	TZ2484	\$453	\$680
29" x 46"	TZ2946	\$324	\$486
29" x 52"	TZ2952	\$366	\$549
29" x 58"	TZ2958	\$404	\$606
29" x 64"	TZ2964	\$445	\$668
29" x 70"	TZ2970	\$484	\$726
29" x 76"	TZ2976	\$526	\$789
29" x 82"	TZ2982	\$565	\$848
30" x 42"	TZ3042	\$285	\$428
30" x 48"	TZ3048	\$324	\$486
30" x 54"	TZ3054	\$366	\$549
30" x 60"	TZ3060	\$404	\$606
30" x 66"	TZ3066	\$445	\$668
30" x 72"	TZ3072	\$484	\$726
30" x 78"	TZ3078	\$526	\$789
30" x 84"	TZ3084	\$565	\$848

TABLE TOP

1. Tabletop (Cont.)

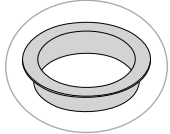
Grommet Location	Code	Price	
None	GP00	+ \$0	
Left	GP01	+ \$30	
Center	GP02	+ \$30	
Right	GP03	+ \$30	
Left and Center	GP04	+ \$60	
Left and Right	GP05	+ \$60	
Right and Center	GP06	+ \$60	
Left, Right and Center	GP07	+ \$90	
Grommet Color	Code	Price	
Black	GC01	+ \$0	
White	GC02	+ \$0	
Pilot Holes	Code	Price	
No Pre-Drilling for Accessories	BNDL00	+ \$0	

EFFECTIVE NOVEMBER 4, 2024

1. Base

Product Type	Code	Price	
2-Leg Base	3302	Priced by Style	

Base Style	Code	Price	
------------	------	-------	--

2-Stage T-Leg Base

TBT6

\$784

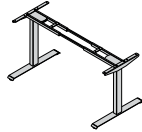

2-Stage C-Leg Base

TBT6C

\$784

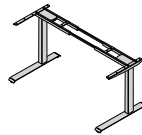

2. Finish

Product Type	Code	Price	
--------------	------	-------	--

Silver

BF01

+ \$0

White

BF02

+ \$0

Black

BF03

+ \$0

TABLE BASE

3. Matching Tabletop

Tabletop Shape	Code	Price	
Rectangular	TZ	Priced by Style	

Tabletop Size	Code	Price	
---------------	------	-------	--

23" x 46" TZ2346 + \$0 + \$0

23" x 52" TZ2352 + \$0 + \$0

23" x 58" TZ2358 + \$0 + \$0

23" x 64" TZ2364 + \$0 + \$0

23" x 70" TZ2370 + \$0 + \$0

23" x 76" TZ2376 + \$0 + \$0

23" x 82" TZ2382 + \$0 + \$0

24" x 42" TZ2442 + \$0 + \$0

24" x 48" TZ2448 + \$0 + \$0

24" x 54" TZ2454 + \$0 + \$0

24" x 60" TZ2460 + \$0 + \$0

24" x 66" TZ2466 + \$0 + \$0

24" x 72" TZ2472 + \$0 + \$0

24" x 78" TZ2478 + \$0 + \$0

24" x 84" TZ2484 + \$0 + \$0

29" x 46" TZ2946 + \$0 + \$0

29" x 52" TZ2952 + \$0 + \$0

29" x 58" TZ2958 + \$0 + \$0

29" x 64" TZ2964 + \$0 + \$0

29" x 70" TZ2970 + \$0 + \$0

29" x 76" TZ2976 + \$0 + \$0

29" x 82" TZ2982 + \$0 + \$0

30" x 42" TZ3042 + \$0 + \$0

30" x 48" TZ3048 + \$0 + \$0

30" x 54" TZ3054 + \$0 + \$0

30" x 60" TZ3060 + \$0 + \$0

30" x 66" TZ3066 + \$0 + \$0

30" x 72" TZ3072 + \$0 + \$0

30" x 78" TZ3078 + \$0 + \$0

30" x 84" TZ3084 + \$0 + \$0

Switchback

2-LEG HEIGHT-ADJUSTABLE TABLE BUNDLE

Find your fit.

Create a smarter workplace solution with Switchback, our number one height-adjustable table. Known for its class-leading anti-collision technology, compact shipping size and instant installation, it's the go-to for a dynamic workspace—and it gets even better when you bundle it with screens, power modules and keyboard trays for a complete, multifunctional workstation.



EFFECTIVE NOVEMBER 4, 2024

Featured Models

ALL-IN-ONE :: \$4,791

2-leg 3-stage base, fixed glides, 24" x 60" pre-drilled rectangular tabletop, no grommets, height-adjustable screen mount, 30" x 60" fabric screen, Cable Caddy basket with power strip, laptop tray with HAT mechanism and U-brackets for crossrails, mini platform keyboard tray with mini trackless mechanism, half moon pencil drawer, Current clamp mount power module, Unity G2 single screen monitor arm, mobile pedestal with upholstered pad

Features

- The bundle can be built with any of Switchback's 2-leg models
- Switchback has three available base finishes and eleven tabletop finishes to fit your style
- Bundles have easy specification and installation; order together and the pilot holes for the accessories will be predrilled and ready to go
- Multiple monitor arm choices, including heavy duty options that support up to 33 lb
- Wire management and power module options to keep all of your electronics organized and powered on

1. Switchback Tabletop

Product Type	Code	Price
Tabletop	3161	Priced by Size
Product Style	Code	Price
3-Stage T-Leg Base	TBT7	Priced by Size
3-Stage, C-Leg Base	TBT7C	Priced by Size
Laminate	Code	Price
Grade 1		
Ankara Cherry	TL18	Priced by Size
Black	TL19	Priced by Size
Brazilian Walnut	TL20	Priced by Size
Cabinet Maple	TL21	Priced by Size
Driftwood	TL23	Priced by Size
Folkstone Grey	TL24	Priced by Size
Libretti	TL25	Priced by Size
Queenston Oak	TL26	Priced by Size
Sandalwood	TL27	Priced by Size
Walnut Amati	TL28	Priced by Size
White	TL29	Priced by Size

SWITCHBACK BUNDLE

1. Switchback Tabletop (Cont.)

Laminate	Code	Price
Grade 2		
Classic Linen	TL17	Priced by Size
Colombian Walnut	TL55	Priced by Size
Crisp Linen	TL64	Priced by Size
Designer White	TL66	Priced by Size
Field Elm	TL13	Priced by Size
Frosty White	TL16	Priced by Size
Grey	TL62	Priced by Size
Grey Elm	TL51	Priced by Size
Kingswood Walnut	TL53	Priced by Size
Manitoba	TL56	Priced by Size
Neo Walnut	TL50	Priced by Size
Platinum	TL61	Priced by Size
Portico Teak	TL60	Priced by Size
Skyline Walnut	TL15	Priced by Size
Steel Mesh	TL59	Priced by Size
Tuscan Walnut	TL57	Priced by Size
Uptown Walnut	TL14	Priced by Size
Laminate Grade	Code	Price
Laminate Grade 1	GR1	Priced by Size
Laminate Grade 2	GR2	Priced by Size
Tabletop Shape	Code	Price
Rectangular	TZ	Priced by Size

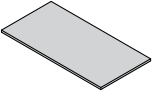

Tabletop Size	Code	Laminate Price	
Rectangular (D x W)		Grade 1	Grade 2
		24" x 60"	2460
24" x 66"	2466	\$358	\$537
24" x 72"	2472	\$389	\$584
30" x 60"	3060	\$404	\$606
30" x 66"	3066	\$445	\$668
30" x 72"	3072	\$484	\$726

SWITCHBACK

EFFECTIVE NOVEMBER 4, 2024

1. Switchback Tabletop (Cont.)

Grommet Location	Code	Price
None	GP00	+ \$0
Left	GP01	+ \$30
Center	GP02	+ \$30
Right	GP03	+ \$30
Left and Center	GP04	+ \$60
Left and Right	GP05	+ \$60
Right and Center	GP06	+ \$60
Left, Right and Center	GP07	+ \$90

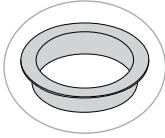

Grommet Color	Code	Price
Black	GC01	+ \$0
White	GC02	+ \$0

Pilot Holes	Code	Price
Pre-Drilled for Accessories	BNDL01	+ \$0

2. Switchback 2-Leg Base

Product Type	Code	Price
2-Leg Base	3162	Priced by Style

Base Style	Code	Price
3-Stage T-Leg Base	TBT7	\$1,005
3-Stage C-Leg Base	TBT7C	\$1,005

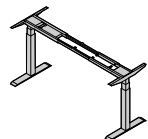
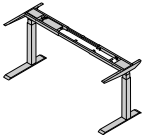
Matching Tabletop Shape	Code	Price
Rectangular	TZ	Priced by Style

Matching Tabletop Size (D x W)	Code	Price
24" x 60"	2460	Priced by Style
24" x 66"	2466	Priced by Style
24" x 72"	2472	Priced by Style
30" x 60"	3060	Priced by Style
30" x 66"	3066	Priced by Style
30" x 72"	3072	Priced by Style

Paint Color	Code	Price
Silver	BF01	+ \$0
White	BF02	+ \$0
Black	BF03	+ \$0

SWITCHBACK BUNDLE

2. Switchback 2-Leg Base (Cont.)

Foot Style	Code	Price
Glides	LS18	+ \$0
Casters	LS19	+ \$109

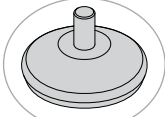
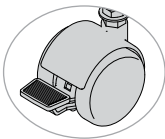
3. Screens

Product Type	Code	Price
Screen	3163	Priced by Size

Screen Material	Code	Price
Frosted Acrylic	DT101	+ \$0
Fabric	DT701	+ \$0
Markerboard	DT301	+ \$0

Screen Size	Code	Price
Frosted Acrylic		
24" x 60"	DS2460	\$569
24" x 66"	DS2466	\$625
24" x 72"	DS2472	\$683
30" x 60"	DS3060	\$711
30" x 66"	DS3066	\$781
30" x 72"	DS3072	\$851
Fabric		
24" x 60"	DS2460	\$593
24" x 66"	DS2466	\$657
24" x 72"	DS2472	\$731
30" x 60"	DS3060	\$717
30" x 66"	DS3066	\$738
30" x 72"	DS3072	\$757
Markerboard		
24" x 60"	DS2460	\$525
24" x 66"	DS2466	\$577
24" x 72"	DS2472	\$629
30" x 60"	DS3060	\$635
30" x 66"	DS3066	\$697
30" x 72"	DS3072	\$761

SWITCHBACK

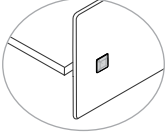
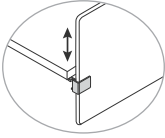

EFFECTIVE NOVEMBER 4, 2024

3. Screens (Cont.)

Mount Style	Code	Price	
Midway	MT5	+ \$76	
Height-Adjustable	MT6	+ \$80	

Height-adjustable mount only available with 30" x 60" screen.

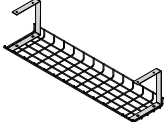
4. Wire Management

Product Type	Code	Price	
Cable Caddy	3152 WM03	\$178	
Cable Caddy Basket	3152 WM05	\$98	
Cable Caddy Clips	3152 WM01	\$82	
Cable Caddy Slim	3152 WM02	\$64	

5. Power Strip

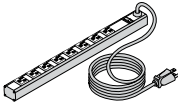
Product Type	Code	Price	
Power Strip	3130 PST1 WM00	\$218	

SWITCHBACK BUNDLE

6. Laptop Tray

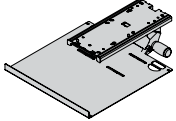
Product Type	Code	Price	
Laptop Tray	3154	Priced by Style	
Mechanism Style	Code	Price	
HAT	KBM01	\$154	
Platform Style	Code	Price	
Laptop Tray	KBP01	+ \$157	
Brackets	Code	Price	
U-Brackets for Crossrails	KBTA	+ \$114	

7. Keyboard Tray

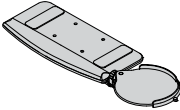
Product Type	Code	Price	
Keyboard Tray	3151	Priced by Style	
Mechanism Style	Code	Price	
Mini Trackless	KBM04	\$330	
Platform Style	Code	Price	
Mini Platform	KBP03	+ \$327	

8. Pencil Storage

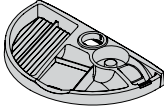
Product Type	Code	Price	
Half Moon	3155 PDT02	\$125	

SWITCHBACK

EFFECTIVE NOVEMBER 4, 2024

9. Power Module

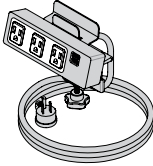
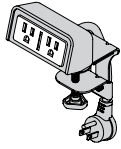
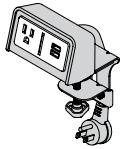
Product Type	Code	Price	
Power	3130	Priced by Style	
Product Style	Code	Price	
Current With Clamp Mount	PCC	\$278	
EON Clamp On, Dual Outlet	PTC PT5	\$128	
EON Clamp On, Single Outlet, Dual USB	PTC PT2	\$185	
Power Color	Code	Price	
White	PC4	+ \$0	
Black	PC1	+ \$0	

10. Monitor Arm

Product Type	Code	Price	
Unity G2 Monitor Arm	3111	Priced by Style	
Mobio Monitor Arm	3210	Priced by Style	

SWITCHBACK BUNDLE

10. Monitor Arm (Cont.)

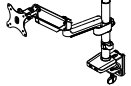
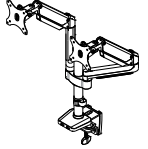
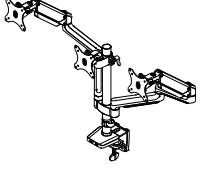
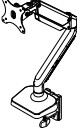
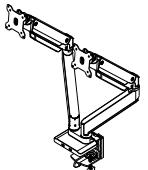
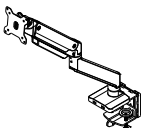
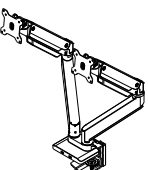
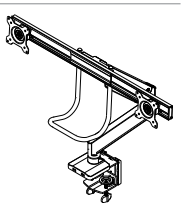
Product Style	Code	Price	
Mobio			
Single Pole	MAT30	\$387	
Dual Pole	MAT31	\$696	
Triple Pole	MAT32	\$807	
Single Desk	MAT33	\$303	
Dual Desk	MAT34	\$605	
Heavy Duty Single Desk	MAT35	\$473	
Heavy Duty Dual Desk	MAT36	\$1,060	
Heavy Duty Dual Array	MAT37	\$702	

EFFECTIVE NOVEMBER 4, 2024

10. Monitor Arm (Cont.)

Product Style	Code	Price
Unity G2		

Single Monitor Arm	MAT06	\$356
--------------------	-------	-------

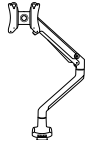

Dual Monitor Arm	MAT07	\$707
------------------	-------	-------

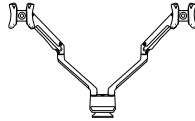

Paint Color	Code	Price
Black	MAC03	+ \$0
Silver	MAC01	+ \$0
White	MAC02	+ \$0

Mobio HD monitor arms are available in silver only. Black finish available on Mobio monitor arms only (not available on heavy duty models).

11. Mobile Pedestal

Product Type	Code	Price
Mobile Pedestal	3150	\$364

Product Style	Code	Price
No Upholstered Pad	CPT00	+ \$0
Upholstered Pad	CPT01	+ \$144

No Upholstered Pad	CPT00	+ \$0
--------------------	-------	-------

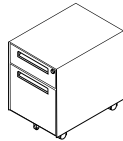

Upholstered Pad	CPT01	+ \$144
-----------------	-------	---------

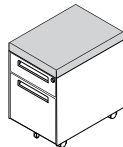

Paint Color	Code	Price
Silver	PDC01	+ \$0
White	PDC02	+ \$0

Fabric Grade (CPT01 Only)	Code	Price
Fabric/Vinyl Grade 1	FG1/VG1	+ \$0
Fabric/Vinyl Grade 2	FG2/VG2	+ \$11
Fabric/Vinyl Grade 3	FG3/VG3	+ \$30
Fabric/Vinyl Grade 4	FG4/VG4	+ \$52
Fabric/Vinyl Grade 5	FG5/VG5	+ \$90
Fabric/Vinyl Grade 6	FG6/VG6	+ \$127
Fabric/Vinyl Grade 7	FG7/VG7	+ \$165

Please reference the [Textile Reference Guide](#) for pricing on fabric over grade 7.

Switchback

2-LEG HEIGHT-ADJUSTABLE TABLE

Find your fit.

Achieving the perfect position maximizes ergonomics and minimizes fatigue or injury. With the press of a button, you can make Switchback height-adjustable table elevate the way you work while ensuring it matches your unique needs. Configure your Switchback with a variety of leg options and an extensive portfolio of tabletop shapes and workstation add-ons. All that and quick installation make Switchback a leading solution in simplicity and endless versatility.



3-Stage T-Leg
Featured with a Sandalwood laminate.
Chair sold separately; see [page 74](#) for Focus 2.0

EFFECTIVE NOVEMBER 4, 2024

Featured Models

SMALL 3-STAGE T-LEG :: **\$1,266**

3-Stage T-leg base, 30" x 60" laminate top, grade 1 laminate, no grommets, glides

MEDIUM 3-STAGE T-LEG :: **\$1,409**

3-Stage T-leg base, 30" x 60" laminate top, grade 1 laminate, no grommets, glides

LARGE 3-STAGE C-LEG :: **\$1,489**

3-Stage C-leg base, 30" x 72" laminate top, grade 1 laminate, no grommets, glides

2-LEG HEIGHT-ADJUSTABLE TABLE

TOPS AND BASES ARE SPECIFIED AND SOLD SEPARATELY.

Features

- Gyro anti-collision technology from a patented sensor stops (and retracts) the table when it makes contact with any object
- Push-button controls with four user-customized positions
- Available with T-leg or C-leg options
- Eleven different durable laminate options to fit your style
- Three durable powder-coated metal base finishes in silver, black or white
- Optional grommets for easy and clean setup of electronic devices
- Chicago Code Compliant (3-conductor type cord with grounded 3-prong molded case plug)
- Meets G1 ANSI BIFMA Certification

SPECIFICATIONS

	3161 TBT8/ TBT7C 3-Stage Switchback
Height Range	22.6"-48.7"
Foot Length With 24" Wide Tabletop	21.65" (T-Leg) 22.83" (C-Leg)
Foot Length With 30" Wide Tabletop	29.53"
Tabletop Thickness	1.125
Adjustment Speed	1.5" Per Second
Standby Power Consumption	<0.1W
Noise	Approximately 39 DB
Power Cord Length	98.5"
Weight Capacity Warranty	265 lb

See the Stand-Alone Tabletop appendix on [page 489](#) for tabletop weights.

TABLETOP FOR 2-LEG BASE

TOPS AND BASES ARE SPECIFIED AND SOLD SEPARATELY.

1. Product

Product Type	Code	Price
Tabletop	3161	Priced by Size

Product Style	Code	Price
For 3-Stage T-Leg Base	TBT7	Priced by Size
For 3-Stage, C-Leg Base	TBT7C	Priced by Size

2. Finish

Laminate Color	Code	Price
Grade 1		
Ankara Cherry	TL18	Priced by Size
Black	TL19	Priced by Size
Brazilian Walnut	TL20	Priced by Size
Cabinet Maple	TL21	Priced by Size
Driftwood	TL23	Priced by Size
Folkstone Grey	TL24	Priced by Size
Libretti	TL25	Priced by Size
Queenston Oak	TL26	Priced by Size
Sandalwood	TL27	Priced by Size
Walnut Amati	TL28	Priced by Size
White	TL29	Priced by Size
Grade 2		
Classic Linen	TL17	Priced by Size
Colombian Walnut	TL55	Priced by Size
Crisp Linen	TL64	Priced by Size
Designer White	TL66	Priced by Size
Field Elm	TL13	Priced by Size
Frosty White	TL16	Priced by Size
Grey	TL62	Priced by Size
Grey Elm	TL51	Priced by Size
Kingswood Walnut	TL53	Priced by Size
Manitoba	TL56	Priced by Size
Neo Walnut	TL50	Priced by Size
Platinum	TL61	Priced by Size
Portico Teak	TL60	Priced by Size
Skyline Walnut	TL15	Priced by Size
Steel Mesh	TL59	Priced by Size
Tuscan Walnut	TL57	Priced by Size
Uptown Walnut	TL14	Priced by Size
Laminate Grade	Code	Price
Laminate Grade 1	GR1	Priced by Size
Laminate Grade 2	GR2	Priced by Size

3. Shape

Tabletop Shape	Code	Price
Rectangular Tabletop	TZ	Priced by Size

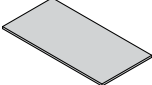

4. Size

Tabletop Size (D x W)	Code	Price	
Standard Sizes		Grade 1	Grade 2
24" x 42"	2442	\$229	\$344
24" x 48"	2448	\$261	\$392
24" x 54"	2454	\$292	\$438
24" x 60"	2460	\$324	\$486
24" x 66"	2466	\$358	\$537
24" x 72"	2472	\$389	\$584
24" x 78"	2478	\$421	\$632
24" x 84"	2484	\$453	\$680
30" x 42"	3042	\$285	\$428
30" x 48"	3048	\$324	\$486
30" x 54"	3054	\$366	\$549
30" x 60"	3060	\$404	\$606
30" x 66"	3066	\$445	\$668
30" x 72"	3072	\$484	\$726
30" x 78"	3078	\$526	\$789
30" x 84"	3084	\$565	\$848
For Use with eBEAM (-2")		Grade 1	Grade 2
24" x 46"	2446	\$261	\$392
24" x 58"	2458	\$324	\$486
24" x 70"	2470	\$389	\$584
30" x 46"	3046	\$324	\$486
30" x 58"	3058	\$404	\$606
30" x 70"	3070	\$484	\$726

TABLETOP FOR 2-LEG BASE

TOPS AND BASES ARE SPECIFIED AND SOLD SEPARATELY.

5. Grommets

Grommet Location	Code	Price
None	GP00	+ \$0
Left	GP01	+ \$30
Center	GP02	+ \$30
Right	GP03	+ \$30
Left and Center	GP04	+ \$60
Left and Right	GP05	+ \$60
Right and Center	GP06	+ \$60
Left, Right and Center	GP07	+ \$90

Grommet Color	Code	Price
Black	GC01	+ \$0
White	GC02	+ \$0

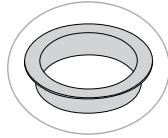

3-Stage C-Leg
 Featured with a Driftwood laminate.
 Chair sold separately; see [page 200](#) for Wit.

SWITCHBACK

EFFECTIVE NOVEMBER 4, 2024 | GSA SIN #: 33721

1. Product

Product Type	Code	Price
Switchback 2-Leg Base	3162	Priced by Style

Product Style	Code	Price
---------------	------	-------

3-Stage T-Leg Base

TBT7

\$1,005

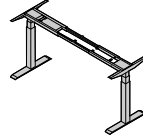

3-Stage C-Leg Base

TBT7C

\$1,005

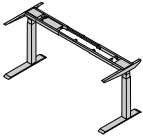

2. Base Finish

Paint Color	Code	Price
Silver	BF01	+ \$0
White	BF02	+ \$0
Black	BF03	+ \$0

2-LEG HEIGHT-ADJUSTABLE BASE

TOPS AND BASES ARE SPECIFIED AND SOLD SEPARATELY.

3. Matching Tabletop

Tabletop Shape	Code	Price
Rectangular Tabletop	TZ	Priced by Size

Tabletop Size	Code	Price
---------------	------	-------

Standard Sizes (D x W)

24" x 42"	2442	+ \$0
24" x 48"	2448	+ \$0
24" x 54"	2454	+ \$0
24" x 60"	2460	+ \$0
24" x 66"	2466	+ \$0
24" x 72"	2472	+ \$0
24" x 78"	2478	+ \$0
24" x 84"	2484	+ \$0
30" x 42"	3042	+ \$0
30" x 48"	3048	+ \$0
30" x 54"	3054	+ \$0
30" x 60"	3060	+ \$0
30" x 66"	3066	+ \$0
30" x 72"	3072	+ \$0
30" x 78"	3078	+ \$0
30" x 84"	3084	+ \$0

For Use with eBEAM (-2") (D x W)

24" x 46"	2446	+ \$0
24" x 58"	2458	+ \$0
24" x 70"	2470	+ \$0
30" x 46"	3046	+ \$0
30" x 58"	3058	+ \$0
30" x 70"	3070	+ \$0

Bases require the specification of a tabletop size. Bases take their size from their corresponding tabletop size.

4. Feet

Foot Style	Code	Price
------------	------	-------

Glides

LS18

+ \$0

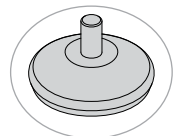

Casters

LS19

+ \$109

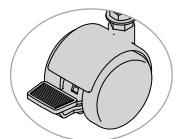

Switchback

3-LEG HEIGHT-ADJUSTABLE TABLE TYPICALS

Find your fit.

Achieving the perfect position maximizes ergonomics and minimizes fatigue or injury. With the press of a button, you can make the Switchback height-adjustable table elevate the way you work while ensuring it matches your unique needs. Configure your height-adjustable table with a variety of leg options and an extensive portfolio of top shapes and workstation add-ons. All that and quick installation make Switchback a leading solution in simplicity and endless versatility.



T-Shape Collaborative



U-Shape



Pod



Extended Offset U-Shape



Extended Offset Corner With Return

EFFECTIVE NOVEMBER 4, 2024 | GSA SIN #: 33721

1. Pod Typical

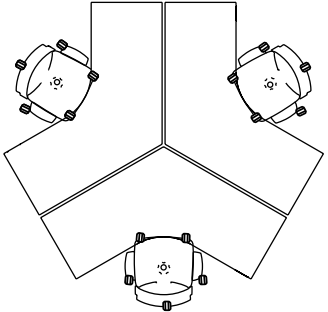
Category	Code	Quantity	Description	List Price	Ext. Price	
Tabletop	3161 TBT8C TA2448 TL27 GR1 GP00	3	120-Degree Tabletop: 24" x 48", Laminate, Grade 1 Laminate, No Grommets	\$908	\$2,724	
Table Base	3162 TBT8C TA2448 BF01	3	3-Leg Base (Pairs With 24" x 48" 120-Degree Tabletop)	\$1,705	\$5,115	

TOTAL: \$7,839

2. U-Shape Typical

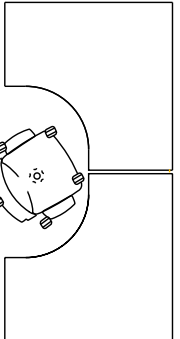
Category	Code	Quantity	Description	List Price	Ext. Price	
Tabletop	3161 TBT8C TBCR2448 TL27 GR1 GP00	1	Right 90-Degree Tabletop: 24" x 48", Grade 1 Laminate, No Grommets	\$517	\$517	
Tabletop	3161 TBT8C TBCL2448 GR1 TL27 GP00	1	Left 90-Degree Tabletop: 24" x 48", Grade 1 Laminate, No Grommets	\$517	\$517	
Table Base	3162 TBT8C TBCL2448 BF01	1	3-Leg Base (Pairs With 24" x 48" 90-Degree Left Tabletop)	\$1,705	\$1,705	
Table Base	3162 TBT8C TBCR2448 BF01	1	3-Leg Base (Pairs With 24" x 48" 90-Degree Right Tabletop)	\$1,705	\$1,705	

TOTAL: \$4,444

3. Extended Offset U-Shape Typical

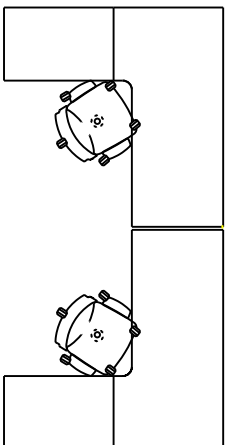
Category	Code	Quantity	Description	List Price	Ext. Price	
Tabletop	3161 TBT8C OR24367230 TL27 GR1 GP00	1	Right Extended Offset Corner Tabletop: 24" x 36" x 72" x 30", Grade 1 Laminate, No Grommets	\$685	\$685	
Tabletop	3161 TBT8C OL30723624 GR1 TL27 GP00	1	Left Extended Offset Corner Tabletop: 30" x 72" x 36" x 24", Grade 1 Laminate, No Grommets	\$685	\$685	
Return Top	3164 TBT8C TN2436 TL27 GR1 GPR00	2	Return Top: 24" x 36", Grade 1 Laminate, No Grommets	\$196	\$392	
Table Base	3162 TBT8C OR24367230 TN2436 BF01	1	3-Leg Base, Cross Beam and Extension Cable (Pairs With 24" x 36" x 72" x 30" Right Extended Offset Corner Tabletop and 24" x 36" Return Top)	\$1,929	\$1,929	
Table Base	3162 TBT8C OL30723624 TN2436 BF01	1	3-Leg Base, Cross Beam and Extension Cable (Pairs With 30" x 72" x 36" x 24" Left Extended Offset Corner Tabletop and 24" x 36" Return Top)	\$1,929	\$1,929	

TOTAL: \$5,620

EFFECTIVE NOVEMBER 4, 2024 | GSA SIN #: 33721

4. Extended Offset Corner With Return Typical

Category	Code	Quantity	Description	List Price	Ext. Price	
Tabletop	3161 TBT8C OL30723624 TL27 GR1 GP00	1	Left Extended Offset Corner Tabletop: 24" x 36" x 72" x 30", Laminate, No Grommets	\$685	\$685	
Return Top	3164 TBT8C TN2436 TL27 GR1 GPR00	1	Return Top: 24" x 36", Laminate, No Grommets	\$196	\$196	
Table Base	3162 TBT8C OL30723624 TN2436 BF01	1	3-Leg Base, Cross Beam and Extension Cable (Pairs With 24" x 36" x 72" x 30" Left Extended Corner Tabletop and 24" x 36" Return Top)	\$1,929	\$1,929	

TOTAL: \$2,810

5. T-Shape Collaborative Typical

Category	Code	Quantity	Description	List Price	Ext. Price	
Tabletop	3161 TBT8C TZ3072 TL27 GR1 GP00	2	Rectangular Tabletop: 30" x 72", Laminate, No Grommets	\$484	\$968	
Return Top	3164 TBT8C TN2442 TL27 GR1 GPR00	2	Return Top: 24" x 42", Laminate, No Grommets	\$229	\$458	
Table Base	3162 TBT8C TZ3072 TN2442 BF01	2	3-Leg Base, Cross Beam and Extension Cable (Pairs With 30" x 72" Tabletop and 24" x 42" Return)	\$1,929	\$3,858	

TOTAL: \$5,284

Switchback

3-LEG HEIGHT-ADJUSTABLE TABLE

Find your fit.

Achieving the perfect position maximizes ergonomics and minimizes fatigue or injury. With the press of a button, you can make the Switchback height-adjustable table elevate the way you work while ensuring it matches your unique needs. Configure your Switchback with a variety of leg options and an extensive portfolio of tabletop shapes and workstation add-ons. All that and quick installation make Switchback a leading solution in simplicity and endless versatility.



*3-Leg 120-Degree
Featured with a Folkstone Grey laminate.
Chair sold separately; see [page 188](#) for Vectra*

EFFECTIVE NOVEMBER 4, 2024

Featured Models

3-LEG 90° :: \$2,350

3-leg base with 24" × 60"
90° corner tabletop, laminate grade 1,
no grommets

3-LEG 120° :: \$2,613

3-leg base with 24" × 48"
120° tabletop, laminate grade 1,
no grommets

3-LEG EXTENDED :: \$2,854

3-leg base with 24" × 48" × 72"
right extended corner tabletop,
24" × 24" return top,
laminate grade 1, no grommets

Features

- Gyro anti-collision technology from a patented sensor stops (and retracts) the table when it makes contact with any object
- Push-button controls with four user-customized positions
- C-leg base
- Eleven different durable laminate options to fit your style
- Three durable powder-coated metal finishes in silver, black or white
- Optional grommets for easy and clean setup of electronic devices
- Chicago Code Compliant (3-conductor type cord with grounded 3-prong molded case plug)
- Meets G1 ANSI BIFMA Certification

3-LEG HEIGHT-ADJUSTABLE TABLE

TOPS AND BASES ARE SPECIFIED AND SOLD SEPARATELY.

SPECIFICATIONS

	C-Leg Switchback
Height Range	22.6"-48.7"
Foot Length With 24" Wide Tabletop	22.83"
Foot Length With 30" Wide Tabletop 29.53"	
Tabletop Thickness	1.125"
Adjustment Speed	1.5" Per Second
Standby Power Consumption	<0.1W
Noise	Approximately 39 DB
Power Cord Length	98.5"
Weight Capacity Warranty	265 lb

Height range includes 1.125" tabletop.

See the Stand-Alone Tabletop appendix on [page 489](#) for tabletop weights.

1. Product

Product Type	Code	Price
Tabletop	3161	Priced by Size
Product Style	Code	Price
For Switchback 3-Leg 3-Stage C-Leg Base	TBT8C	Priced by Size

2. Finish

Laminate Color	Code	Price
Grade 1 Laminate		
Ankara Cherry	TL18	Priced by Size
Black	TL19	Priced by Size
Brazilian Walnut	TL20	Priced by Size
Cabinet Maple	TL21	Priced by Size
Driftwood	TL23	Priced by Size
Folkstone Grey	TL24	Priced by Size
Libretti	TL25	Priced by Size
Queenston Oak	TL26	Priced by Size
Sandalwood	TL27	Priced by Size
Walnut Amati	TL28	Priced by Size
White	TL29	Priced by Size
Grade 2 Laminate		
Classic Linen	TL17	Priced by Size
Colombian Walnut	TL55	Priced by Size
Crisp Linen	TL64	Priced by Size
Designer White	TL66	Priced by Size
Field Elm	TL13	Priced by Size
Frosty White	TL16	Priced by Size
Grey	TL62	Priced by Size
Grey Elm	TL51	Priced by Size
Kingswood Walnut	TL53	Priced by Size
Manitoba	TL56	Priced by Size
Neo Walnut	TL50	Priced by Size
Platinum	TL61	Priced by Size
Portico Teak	TL60	Priced by Size
Skyline Walnut	TL15	Priced by Size
Steel Mesh	TL59	Priced by Size
Tuscan Walnut	TL57	Priced by Size
Uptown Walnut	TL14	Priced by Size
Laminate Grade	Code	Price
Laminate Grade 1	GR1	Priced by Size
Laminate Grade 2	GR2	Priced by Size

1-PIECE TABLETOP FOR 3-LEG BASE

TOPS AND BASES ARE SPECIFIED AND SOLD SEPARATELY.

3. Shape

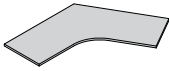
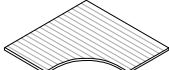
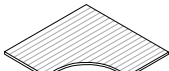
Tabletop Shape	Code	Price	
120-Degree Tabletop	TA	Priced by Size	
Right 90-Degree Tabletop	TBCR	Priced by Size	
Left 90-Degree Tabletop	TBCL	Priced by Size	

4. Size

Tabletop Size	Code	Price	
120-Degree (D x W)		Grade 1	Grade 2
24" x 42"	TA2442	\$705	\$1,058
24" x 48"	TA2448	\$908	\$1,362
30" x 42"	TA3042	\$736	\$1,104
30" x 48"	TA3048	\$917	\$1,376
Right 90-Degree Corner (D x W)		Grade 1	Grade 2
24" x 48"	TBCR2448	\$517	\$776
24" x 54"	TBCR2454	\$582	\$873
24" x 60"	TBCR2460	\$645	\$968
30" x 48"	TBCR3048	\$645	\$968
30" x 54"	TBCR3054	\$729	\$1,094
30" x 60"	TBCR3060	\$805	\$1,208
Left 90-Degree Corner (D x W)		Grade 1	Grade 2
24" x 48"	TBCL2448	\$517	\$776
24" x 54"	TBCL2454	\$582	\$873
24" x 60"	TBCL2460	\$645	\$968
30" x 48"	TBCL3048	\$645	\$968
30" x 54"	TBCL3054	\$729	\$1,094
30" x 60"	TBCL3060	\$805	\$1,208

SWITCHBACK

1-PIECE TABLETOP FOR 3-LEG BASE TOPS AND BASES ARE SPECIFIED AND SOLD SEPARATELY.

EFFECTIVE NOVEMBER 4, 2024 | GSA SIN #: 33721

5. Grommets

Grommet Location	Code	Price
None	GP00	+ \$0
Left	GP01	+ \$30
Center	GP02	+ \$30
Right	GP03	+ \$30
Left and Center	GP04	+ \$60
Left and Right	GP05	+ \$60
Right and Center	GP06	+ \$60
Left, Right and Center	GP07	+ \$90

Grommet Color	Code	Price
Black	GC01	+ \$0
White	GC02	+ \$0

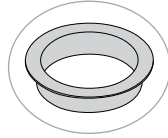

3-Leg 120°
Featured with a Folkstone Grey laminate.
Chair sold separately; see [page 188](#) for Vectra.

1. Product

Product Type	Code	Price
Switchback 3-Leg Base	3162	Priced by Style

Product Style	Code	Price
3-Stage C-Leg Base	TBT8C	\$1,705

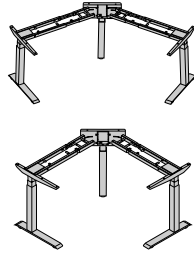

2. Base Finish

Paint Color	Code	Price
Silver	BF01	+ \$0
White	BF02	+ \$0
Black	BF03	+ \$0

3-LEG BASE FOR 1-PIECE TOP

TOPS AND BASES ARE SPECIFIED AND SOLD SEPARATELY.

3. Matching Tabletop

Tabletop Shape	Code	Price
120-Degree Tabletop	TA	Priced by Size
Right 90-Degree Tabletop	TBCR	Priced by Size
Left 90-Degree Tabletop	TBCL	Priced by Size

Tabletop Size	Code	Price
120-Degree Top		
Depth x Width		
24" x 42"	2442	+ \$0
24" x 48"	2448	+ \$0
30" x 42"	3042	+ \$0
30" x 48"	3048	+ \$0

Depth x Width	Right 90-Degree Corner Tabletop	
24" x 48"	2448	+ \$0
24" x 54"	2454	+ \$0
24" x 60"	2460	+ \$0
30" x 48"	3048	+ \$0
30" x 54"	3054	+ \$0
30" x 60"	3060	+ \$0

Depth x Width	Left 90-Degree Corner Tabletop	
24" x 48"	2448	+ \$0
24" x 54"	2454	+ \$0
24" x 60"	2460	+ \$0
30" x 48"	3048	+ \$0
30" x 54"	3054	+ \$0
30" x 60"	3060	+ \$0

Bases require the specification of a tabletop size. Bases take their size from their corresponding tabletop size.

SWITCHBACK

EFFECTIVE NOVEMBER 4, 2024 | GSA SIN #: 33721

1. Product

Product Type	Code	Price
Switchback Tabletop	3161	Priced by Size

Product Style	Code	Price
For 3-Leg 3-Stage C-Leg Base	TBT8C	Priced by Size

2. Finish

Laminate	Code	Price
Grade 1 Laminate		
Ankara Cherry	TL18	Priced by Size
Black	TL19	Priced by Size
Brazilian Walnut	TL20	Priced by Size
Cabinet Maple	TL21	Priced by Size
Driftwood	TL23	Priced by Size
Folkstone Grey	TL24	Priced by Size
Libretti	TL25	Priced by Size
Queenston Oak	TL26	Priced by Size
Sandalwood	TL27	Priced by Size
Walnut Amati	TL28	Priced by Size
White	TL29	Priced by Size
Grade 2 Laminate		
Classic Linen	TL17	Priced by Size
Colombian Walnut	TL55	Priced by Size
Crisp Linen	TL64	Priced by Size
Designer White	TL66	Priced by Size
Field Elm	TL13	Priced by Size
Frosty White	TL16	Priced by Size
Grey	TL62	Priced by Size
Grey Elm	TL51	Priced by Size
Kingswood Walnut	TL53	Priced by Size
Manitoba	TL56	Priced by Size
Neo Walnut	TL50	Priced by Size
Platinum	TL61	Priced by Size
Portico Teak	TL60	Priced by Size
Skyline Walnut	TL15	Priced by Size
Steel Mesh	TL59	Priced by Size
Tuscan Walnut	TL57	Priced by Size
Uptown Walnut	TL14	Priced by Size
Laminate Grade	Code	Price
Laminate Grade 1	GR1	Priced by Size
Laminate Grade 2	GR2	Priced by Size

TABLETOP FOR 3-LEG BASE AND RETURN

TOPS AND BASES ARE SPECIFIED AND SOLD SEPARATELY.

3. Shape

Tabletop Shape	Code	Price
Rectangular	TZ	Priced by Size
Right Extended Corner	TXR	Priced by Size
Left Extended Corner	TXL	Priced by Size
Right Extended Offset	OR	Priced by Size
Left Extended Offset	OL	Priced by Size

4. Size

Tabletop Size	Code	Laminate Price	
Rectangular (D x W)		Grade 1	Grade 2
24" x 48"	2448	\$261	\$392
24" x 54"	2454	\$292	\$438
24" x 60"	2460	\$324	\$486
24" x 66"	2466	\$358	\$537
24" x 72"	2472	\$389	\$584
30" x 48"	3048	\$324	\$486
30" x 54"	3054	\$366	\$549
30" x 60"	3060	\$404	\$606
30" x 66"	3066	\$445	\$668
30" x 72"	3072	\$484	\$726

4. Size (Cont.)

Tabletop Size (Cont.)	Code	Laminate Price	
Right Extended Corner (A x B x C)		Grade 1	Grade 2
24" x 36" x 60"	243660	\$485	\$728
24" x 36" x 66"	243666	\$547	\$821
24" x 36" x 72"	243672	\$618	\$927
24" x 42" x 60"	244260	\$557	\$836
24" x 42" x 66"	244266	\$629	\$944
24" x 42" x 72"	244272	\$710	\$1,065
24" x 48" x 60"	244860	\$613	\$920
24" x 48" x 66"	244866	\$692	\$1,038
24" x 48" x 72"	244872	\$781	\$1,172
30" x 36" x 60"	303660	\$557	\$836
30" x 36" x 66"	303666	\$629	\$944
30" x 36" x 72"	303672	\$760	\$1,140
30" x 42" x 60"	304260	\$640	\$960
30" x 42" x 66"	304266	\$723	\$1,085
30" x 42" x 72"	304272	\$817	\$1,226
30" x 48" x 60"	304860	\$672	\$1,008
30" x 48" x 66"	304866	\$760	\$1,140
30" x 48" x 72"	304872	\$860	\$1,290
Left Extended Corner (A x B x C)		Grade 1	Grade 2
24" x 60" x 36"	246036	\$485	\$728
24" x 66" x 36"	246636	\$547	\$821
24" x 72" x 36"	247236	\$618	\$927
24" x 60" x 42"	246042	\$557	\$836
24" x 66" x 42"	246642	\$629	\$944
24" x 72" x 42"	247242	\$710	\$1,065
24" x 60" x 48"	246048	\$613	\$920
24" x 66" x 48"	246648	\$692	\$1,038
24" x 72" x 48"	247248	\$781	\$1,172
30" x 60" x 36"	306036	\$557	\$836
30" x 66" x 36"	306636	\$629	\$944
30" x 72" x 36"	307236	\$760	\$1,140
30" x 60" x 42"	306042	\$640	\$960
30" x 66" x 42"	306642	\$723	\$1,085
30" x 72" x 42"	307242	\$817	\$1,226
30" x 60" x 48"	306048	\$672	\$1,008
30" x 66" x 48"	306648	\$760	\$1,140
30" x 72" x 48"	307248	\$860	\$1,290

On extended corner tops, the main desk and return have equal depth. Multipiece tops must be paired with returns.

TABLETOP FOR 3-LEG BASE AND RETURN TOPS AND BASES ARE SPECIFIED AND SOLD SEPARATELY.

4. Size (Cont.)

Tabletop Size (Cont.)	Code	Laminate Price	
Right Extended Offset (A x B x C x D)		Grade 1	Grade 2
24" x 36" x 60" x 30"	24366030	\$531	\$797
24" x 36" x 66" x 30"	24366630	\$604	\$906
24" x 36" x 72" x 30"	24367230	\$685	\$1,028
24" x 42" x 60" x 30"	24426030	\$616	\$924
24" x 42" x 66" x 30"	24426630	\$697	\$1,046
24" x 42" x 72" x 30"	24427230	\$793	\$1,190
24" x 48" x 60" x 30"	24486030	\$648	\$972
24" x 48" x 66" x 30"	24486630	\$735	\$1,103
24" x 48" x 72" x 30"	24487230	\$835	\$1,253
Left Extended Offset (A x B x C x D)		Grade 1	Grade 2
30" x 60" x 36" x 24"	30603624	\$531	\$797
30" x 66" x 36" x 24"	30663624	\$604	\$906
30" x 72" x 36" x 24"	30723624	\$685	\$1,028
30" x 60" x 42" x 24"	30604224	\$616	\$924
30" x 66" x 42" x 24"	30664224	\$697	\$1,046
30" x 72" x 42" x 24"	30724224	\$793	\$1,190
30" x 60" x 48" x 24"	30604824	\$648	\$972
30" x 66" x 48" x 24"	30664824	\$735	\$1,103
30" x 72" x 48" x 24"	30724824	\$835	\$1,253

On extended offset corner tops, the main desk has a depth of 30", which tapers down to a depth of 24" on the return. Multipiece tops must be paired with returns.

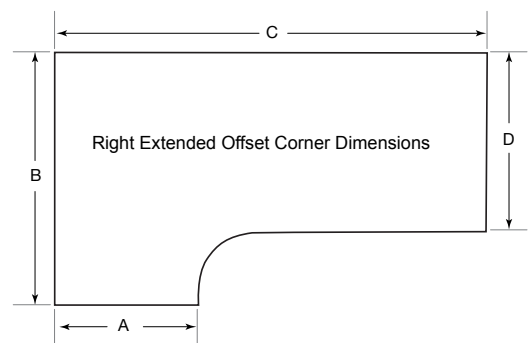
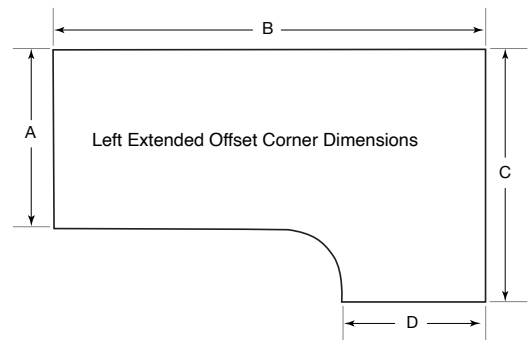

SWITCHBACK

TABLETOP FOR 3-LEG BASE AND RETURN TOPS AND BASES ARE SPECIFIED AND SOLD SEPARATELY.

EFFECTIVE NOVEMBER 4, 2024 | GSA SIN #: 33721

5. Grommets

Grommet Location	Code	Price
None	GP00	+ \$0
Left	GP01	+ \$30
Center	GP02	+ \$30
Right	GP03	+ \$30
Left and Center	GP04	+ \$60
Left and Right	GP05	+ \$60
Right and Center	GP06	+ \$60
Left, Right and Center	GP07	+ \$90

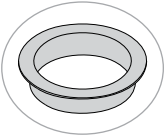

Grommet Color	Code	Price
Black	GC01	+ \$0
White	GC02	+ \$0

Left grommets (GP01/GP04/GP05/GP07) are not available on right extended corners or right extended offset corners.

Right grommets (GP03/GP05/GP06/GP07) are not available on left extended corners or left extended offset corners.



*3-Leg Extended Corner
Featured with a Cabinet Maple laminate tabletop.
Chair sold separately; see [page 132](#) for Novo.*

1. Product

Product Type	Code	Price
Return Top	3164	Priced by Size
Product Style	Code	Price
For Switchback 3-Leg 3-Stage C-Leg Base	TBT8C	Priced by Size

2. Finish

Laminate	Code	Price
Grade 1 Laminate		
Ankara Cherry	TL18	Priced by Size
Black	TL19	Priced by Size
Brazilian Walnut	TL20	Priced by Size
Cabinet Maple	TL21	Priced by Size
Driftwood	TL23	Priced by Size
Folkstone Grey	TL24	Priced by Size
Libretti	TL25	Priced by Size
Queenston Oak	TL26	Priced by Size
Sandalwood	TL27	Priced by Size
Walnut Amati	TL28	Priced by Size
White	TL29	Priced by Size
Grade 2 Laminate		
Classic Linen	TL17	Priced by Size
Colombian Walnut	TL55	Priced by Size
Crisp Linen	TL64	Priced by Size
Designer White	TL66	Priced by Size
Field Elm	TL13	Priced by Size
Frosty White	TL16	Priced by Size
Grey	TL62	Priced by Size
Grey Elm	TL51	Priced by Size
Kingswood Walnut	TL53	Priced by Size
Manitoba	TL56	Priced by Size
Neo Walnut	TL50	Priced by Size
Platinum	TL61	Priced by Size
Portico Teak	TL60	Priced by Size
Skyline Walnut	TL15	Priced by Size
Steel Mesh	TL59	Priced by Size
Tuscan Walnut	TL57	Priced by Size
Uptown Walnut	TL14	Priced by Size
Laminate Grade	Code	Price
Laminate Grade 1	GR1	Priced by Size
Laminate Grade 2	GR2	Priced by Size

RETURN TOP FOR 3-LEG BASE

TOPS AND BASES ARE SPECIFIED AND SOLD SEPARATELY.

3. Shape

Product Shape	Code	Price
Rectangular Return	TN	Priced by Size

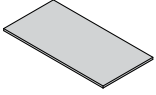

4. Size

Return Top Size	Code	Laminate Price	
Rectangular (D x W)	Code	Grade 1	Grade 2
24" x 24"	2424	\$144	\$216
24" x 30"	2430	\$165	\$248
24" x 36"	2436	\$196	\$294
24" x 42"	2442	\$229	\$344
24" x 48"	2448	\$261	\$392
30" x 24"	3024	\$172	\$258
30" x 30"	3030	\$205	\$308
30" x 36"	3036	\$244	\$366
30" x 42"	3042	\$285	\$428

5. Grommets

Grommet Location	Code	Price
None	GPR00	+ \$0
Left	GPR01	+ \$30
Center	GPR02	+ \$30
Right	GPR03	+ \$30
Grommet Color	Code	Price
Black	GC01	+ \$0
White	GC02	+ \$0

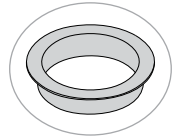

SWITCHBACK

EFFECTIVE NOVEMBER 4, 2024 | GSA SIN #: 33721

1. Base

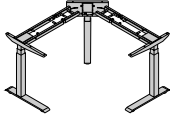
Product Type	Code	Base	
3-Leg 3-Stage C-Leg Base	3162 TBT8C	\$1,705	

2. Finish

Paint Color	Code	Price	
Silver	BF01	+ \$0	
White	BF02	+ \$0	
Black	BF03	+ \$0	

3. Matching Tabletop

Tabletop Shape	Code	Price	
Rectangular	TZ	+ \$0	
Right Extended Corner	TXR	+ \$0	
Left Extended Corner	TXL	+ \$0	
Right Extended Offset	OR	+ \$0	
Left Extended Offset	OL	+ \$0	

Tabletop Size	Code	Price	
Rectangular (D x W)			
24" x 48"	2448	+ \$0	
24" x 54"	2454	+ \$0	
24" x 60"	2460	+ \$0	
24" x 66"	2466	+ \$0	
24" x 72"	2472	+ \$0	
30" x 48"	3048	+ \$0	
30" x 54"	3054	+ \$0	
30" x 60"	3060	+ \$0	
30" x 66"	3066	+ \$0	
30" x 72"	3072	+ \$0	

3-LEG BASE FOR TABLETOP AND RETURN

TOPS AND BASES ARE SPECIFIED AND SOLD SEPARATELY.

3. Matching Tabletop Size (Cont.)

Tabletop Size	Code	Price	
Right Extended Corner (A x B x C)			
24" x 36" x 60"	243660	+ \$0	
24" x 36" x 66"	243666	+ \$0	
24" x 36" x 72"	243672	+ \$0	
24" x 42" x 60"	244260	+ \$0	
24" x 42" x 66"	244266	+ \$0	
24" x 42" x 72"	244272	+ \$0	
24" x 48" x 60"	244860	+ \$0	
24" x 48" x 66"	244866	+ \$0	
24" x 48" x 72"	244872	+ \$0	
30" x 36" x 60"	303660	+ \$0	
30" x 36" x 66"	303666	+ \$0	
30" x 36" x 72"	303672	+ \$0	
30" x 42" x 60"	304260	+ \$0	
30" x 42" x 66"	304266	+ \$0	
30" x 42" x 72"	304272	+ \$0	
30" x 48" x 60"	304860	+ \$0	
30" x 48" x 66"	304866	+ \$0	
30" x 48" x 72"	304872	+ \$0	
Left Extended Corner (A x B x C)			
24" x 60" x 36"	246036	+ \$0	
24" x 66" x 36"	246636	+ \$0	
24" x 72" x 36"	247236	+ \$0	
24" x 60" x 42"	246042	+ \$0	
24" x 66" x 42"	246642	+ \$0	
24" x 72" x 42"	247242	+ \$0	
24" x 60" x 48"	246048	+ \$0	
24" x 66" x 48"	246648	+ \$0	
24" x 72" x 48"	247248	+ \$0	
30" x 60" x 48"	306048	+ \$0	
30" x 66" x 36"	306636	+ \$0	
30" x 72" x 36"	307236	+ \$0	
30" x 60" x 42"	306042	+ \$0	
30" x 66" x 42"	306642	+ \$0	
30" x 72" x 42"	307242	+ \$0	
30" x 60" x 48"	306048	+ \$0	
30" x 66" x 48"	306648	+ \$0	
30" x 72" x 48"	307248	+ \$0	

3. Matching Tabletop Size (Cont.)

Tabletop Size	Code	Price
Right Extended Offset (A x B x C x D)		
24" x 36" x 60" x 30"	24366030	+ \$0
24" x 36" x 66" x 30"	24366630	+ \$0
24" x 36" x 72" x 30"	24367230	+ \$0
24" x 42" x 60" x 30"	24426030	+ \$0
24" x 42" x 66" x 30"	24426630	+ \$0
24" x 42" x 72" x 30"	24427230	+ \$0
24" x 48" x 60" x 30"	24486030	+ \$0
24" x 48" x 66" x 30"	24486630	+ \$0
24" x 48" x 72" x 30"	24487230	+ \$0
Left Extended Offset (A x B x C x D)		
30" x 60" x 36" x 24"	30603624	+ \$0
30" x 66" x 36" x 24"	30663624	+ \$0
30" x 72" x 36" x 24"	30723624	+ \$0
30" x 60" x 42" x 24"	30604224	+ \$0
30" x 66" x 42" x 24"	30664224	+ \$0
30" x 72" x 42" x 24"	30724224	+ \$0
30" x 60" x 48" x 24"	30604824	+ \$0
30" x 66" x 48" x 24"	30664824	+ \$0
30" x 72" x 48" x 24"	30724824	+ \$0

Bases require the specification of a tabletop size. Bases take their size from their corresponding tabletop size.

4. Matching Return

Return Shape	Code	Price
Rectangular Return	TN	Priced by Size
Return Top Size		
No Return	TN0	+ \$0
24" x 24"	TN2424	+ \$74
24" x 30"	TN2430	+ \$74
24" x 36"	TN2436	+ \$74
24" x 42"	TN2442	+ \$74
24" x 48"	TN2448	+ \$74
30" x 24"	TN3024	+ \$74
30" x 30"	TN3030	+ \$74
30" x 36"	TN3036	+ \$74
30" x 42"	TN3042	+ \$74

3-LEG BASE FOR TABLETOP AND RETURN

TOPS AND BASES ARE SPECIFIED AND SOLD SEPARATELY.

5. Base Extension

Parts	Code	Price
Cross Beam and Extension Cable	No Code	+ \$150

A base extension charge will be added automatically if the A or D measurement is equal to 72".

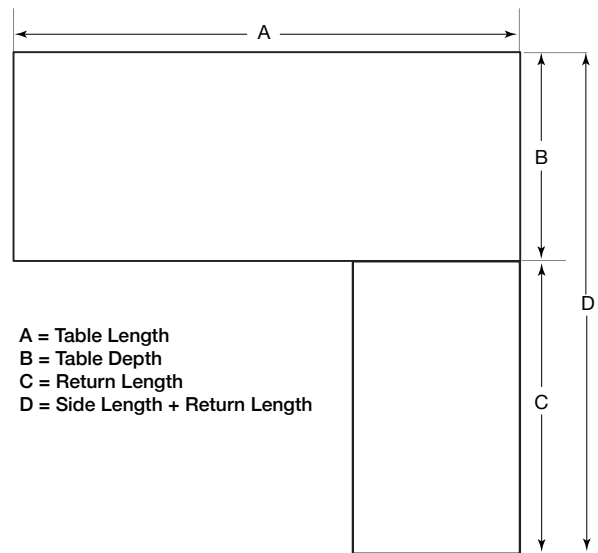
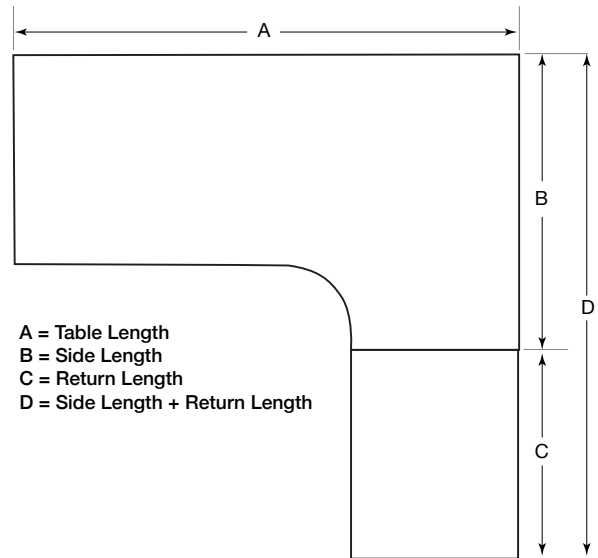

Tensor

CAFÉ, CLASSROOM, AND OFFICE TYPICALS

As your business grows and changes, your workspace should be able to keep up. That's why we created Tensor—one table that can adapt to your changing needs. It's the only table that can expand to support multiple tops on a single base. This allows you to install and reconfigure to fit any space quickly and easily.



L-Shaped With Main and Return



Conference



U-Shaped With Bridge



Multipurpose U-Shape



Classroom-Style Training



Café

EFFECTIVE NOVEMBER 4, 2024

1. Café Typical

Category	Code	Quantity	Description	List Price	Ext Price	
Tabletop	3231 TBT9 TZ1872 TL27 GP00	2	Rectangular Tabletop: 18" x 72", Laminate, No Grommets	\$300	\$600	
Tabletop	3231 TBT9 TS4242 TL27	2	Square Tabletop: 42" x 42", Laminate	\$400	\$800	
Tabletop	3231 TBT9 TR4242 TL27	2	Round Tabletop: 42" x 42", Laminate	\$400	\$800	
Table Base	3232 TBT9 TZ1872 BF01	2	Base (Pairs With Rectangular 18" x 72" Tabletop)	\$606	\$1,212	
Table Base	3232 TBT9 TS4242 BF01	2	Base (Pairs With 42" x 42" Square Tabletop)	\$533	\$1,066	
Table Base	3232 TBT9 TR4242 BF01	2	Base (Pairs With 42" x 42" Round Tabletop)	\$533	\$1,066	
					TOTAL:	\$5,544

2. Classroom-Style Training Typical

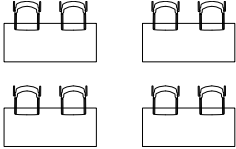
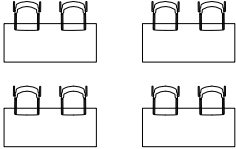
Category	Code	Quantity	Description	List Price	Ext Price	
Tabletop	3231 TBT9 TZ3072 TL24 GP00	8	Rectangular Tabletop: 30" x 72", Laminate, No Grommets	\$484	\$3,872	
Table Base	3232 TBT9 TZ3072 BF01	8	Base (Pairs With 30" x 72" Rectangular Tabletop)	\$606	\$4,848	
					TOTAL:	\$8,720

3. Multipurpose U-Shape Typical

Category	Code	Quantity	Description	List Price	Ext Price	
Tabletop	3231 TBT9 TZ3072 TL22 GP00	8	Rectangular Tabletop: 30" x 72", Laminate, No Grommets	\$484	\$3,872	
Table Base	3232 TBT9 TZ3072 BF01	8	Base (Pairs With 30" x 72" Rectangular Tabletop)	\$606	\$4,848	
Accessories	3159 ATC03 XGV	7	Two Pairs of Ganging Brackets	\$50	\$350	
					TOTAL:	\$9,070

EFFECTIVE NOVEMBER 4, 2024

4. Conference Typical

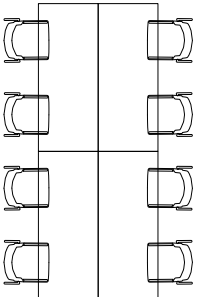
Category	Code	Quantity	Description	List Price	Ext Price	
Tabletop	3231 TBT9 TZ2460 TL27 GP00	4	Rectangular Tabletop: 24" x 60", Laminate, No Grommets	\$324	\$1,296	
Table Base	3232 TBT9 TZ2460 BF01	4	Base (Pairs With 24" x 60" Rectangular Tabletop)	\$580	\$2,320	
Accessories	3159 ATC03 XGV	4	Two Pairs of Ganging Brackets	\$50	\$200	
TOTAL:					\$3,816	

5. L-Shape Typical With Main Desk and Return

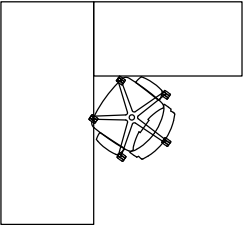
Category	Code	Quantity	Description	List Price	Ext Price	
Tabletop	3231 TBT9 TZ3072 TL27 GP00	1	Rectangular Tabletop: 30" x 72", Laminate, No Grommets	\$484	\$484	
Return Top	3231 TBT9P TN2448 TL27 GPR00	1	Return Top: 24" x 48", Laminate, No Grommets	\$261	\$261	
Table Base	3232 TBT9 TZ3072 BF01	1	Base (Pairs With 30" x 72" Rectangular Tabletop)	\$606	\$606	
Return Base	3232 TBT9P TN2448 BF01	1	Return Base (Pairs With 24" x 48" Return Top)	\$290	\$290	
TOTAL:					\$1,641	

6. U-Shape Typical With Bridge

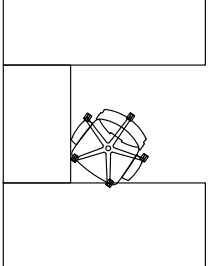
Category	Code	Quantity	Description	List Price	Ext Price	
Desktop	3231 TBT9 TZ3072 TL27 GP00	1	Rectangular Desktop: 30" x 72", Laminate, No Grommets	\$484	\$484	
Credenza Top	3231 TBT9 TZ2472 TL27 GP00	1	Rectangular Credenza Top: 24" x 72", Laminate, No Grommets	\$389	\$389	
Bridgetop	3231 TBT10 TZ2442 TL27	1	Bridgetop: 24" x 42", Laminate	\$229	\$229	
Desk Base	3232 TBT9 TZ3072 BF01	1	Base (Pairs With 30" x 72" Rectangular Tabletop)	\$606	\$606	
Credenza Base	3232 TBT9 TZ2472 BF01	1	Base (Pairs With 24" x 72" Rectangular Tabletop)	\$606	\$606	
Bridge Support	3232 TBT10 TZ2442	1	Mending Brackets (Pairs With 24" x 42" Bridgetop)	\$192	\$192	
TOTAL:					\$2,506	

Tensor

CAFÉ TABLE

One table does it all.

As your business grows and changes, your workspace should be able to keep up. That's why we created Tensor—one table that can adapt to your changing needs. It's the only table that can expand to support multiple top shapes and sizes with a single base. This allows you to install and reconfigure to fit any space quickly and easily.



Round Café Table
Featured with Ankara Cherry laminate.
Chair sold separately; see [page 219](#) for Baja.

EFFECTIVE NOVEMBER 4, 2024

Featured Models

SQUARE :: \$933

42" square tabletop, grade 1 laminate, matching base

ROUND :: \$933

42" round tabletop, grade 1 laminate, matching base

Features

- Patent-pending easy-to-size table support structure adapts to all spaces
- Steel dual-isosceles triangle design evenly distributes and supports weight throughout
- Base accommodates round and square tabletops
Round from 42"-48"; Square from 30"-48"
- Features a minimalistic aesthetic with a below-the-surface configuration
- 28 different durable laminate options to fit your style
- Assembles in less than 10 minutes with pre-installed parts
- 300 lb weight capacity warranty

SPECIFICATIONS

	Tensor Café Table
Height	29.67"
Leg Width	1.8"
Tabletop Thickness	1.125"
Weight Capacity Warranty	300 lb

Height range includes 1.125" tabletop.

See the Stand-Alone Tabletop appendix on [page 623](#) for tabletop weights.

CAFÉ TABLETOP

TOPS AND BASES ARE SPECIFIED AND SOLD SEPARATELY.

1. Product

Product Type	Code	Price
Tabletop	3231 TBT9	Priced by Size

2. Finish

Laminate Color	Code	Price
Grade 1 Laminate		
Ankara Cherry	TL18	Priced by Grade
Black	TL19	Priced by Grade
Brazilian Walnut	TL20	Priced by Grade
Cabinet Maple	TL21	Priced by Grade
Driftwood	TL23	Priced by Grade
Folkstone Grey	TL24	Priced by Grade
Libretti	TL25	Priced by Grade
Queenston Oak	TL26	Priced by Grade
Sandalwood	TL27	Priced by Grade
Walnut Amati	TL28	Priced by Grade
White	TL29	Priced by Grade
Grade 2 Laminate		
Classic Linen	TL17	Priced by Grade
Colombian Walnut	TL55	Priced by Grade
Crisp Linen	TL64	Priced by Grade
Designer White	TL66	Priced by Grade
Field Elm	TL13	Priced by Grade
Frosty White	TL16	Priced by Grade
Grey	TL62	Priced by Grade
Grey Elm	TL51	Priced by Grade
Kingswood Walnut	TL53	Priced by Grade
Manitoba	TL56	Priced by Grade
Neo Walnut	TL50	Priced by Grade
Platinum	TL61	Priced by Grade
Portico Teak	TL60	Priced by Grade
Skyline Walnut	TL15	Priced by Grade
Steel Mesh	TL59	Priced by Grade
Tuscan Walnut	TL57	Priced by Grade
Uptown Walnut	TL14	Priced by Grade
Laminate Grade	Code	Price
Laminate Grade 1	GR1	Priced by Size
Laminate Grade 2	GR2	Priced by Size

EFFECTIVE NOVEMBER 4, 2024

3. Shape

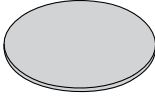
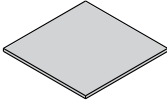
Tabletop Shape	Code	Price	
Round	TR	Priced by Size	
Square	TS	Priced by Size	

Actual size of 30" x 30" tabletop is 30.75" x 30.75".

CAFÉ TABLETOP

TOPS AND BASES ARE SPECIFIED AND SOLD SEPARATELY.

4. Size

Tabletop Size	Code	Price	
Round		Grade 1	Grade 2
42"	4242	\$400	\$600
48"	4848	\$458	\$687
Square		Grade 1	Grade 2
30"	3030	\$331	\$497
36"	3636	\$383	\$575
42"	4242	\$400	\$600
48"	4848	\$458	\$687

Actual size of 30" x 30" tabletop is 30.75" x 30.75".

Square Café Table

Chair sold separately; see page 263 for Mika.



EFFECTIVE NOVEMBER 4, 2024

1. Product

Product Type	Code	Price
Base	3232 TBT9	\$533

2. Base Finish

Paint Color	Code	Price
Silver	BF01	+ \$0
White	BF02	+ \$0
Black	BF03	+ \$0

3. Size

Tabletop Size	Code	Price
No Tabletop	TZ0	+ \$0

Round	TR	+ \$0	
Square	TS	+ \$0	

Table bases require the specification of a tabletop size. Bases take their size from their corresponding top size.

CAFÉ TABLE BASE

TOPS AND BASES ARE SPECIFIED AND SOLD SEPARATELY.

4. Size

Tabletop Size	Code	Price
No Tabletop	TZ0	+ \$0
Round		
42"	4242	+ \$0
48"	4848	+ \$0
Square		
30"	3030	+ \$0
36"	3636	+ \$0
42"	4242	+ \$0
48"	4848	+ \$0

Table bases require the specification of a tabletop size. Bases take their size from their corresponding top size.

Tensor

MULTIPURPOSE TABLE

One table does it all.

As your business grows and changes, your workspace should be able to keep up. That's why we created Tensor—one table that can adapt to your changing needs. It's the only table that can expand to support multiple top shapes and sizes with a single base. This allows you to install and reconfigure to fit any space quickly and easily.



24" x 60" Table

Featured with Libretti laminate.

Chair sold separately; see [page 254](#) for Ioniq Multipurpose.

EFFECTIVE NOVEMBER 4, 2024

Featured Models

18" x 48" :: \$780

18" x 48" tabletop, grade 1 laminate, no grommets, matching base

24" x 60" :: \$904

24" x 60" tabletop, grade 1 laminate, no grommets, matching base

30" x 72" :: \$1,090

30" x 72" tabletop, grade 1 laminate, matching base

Features

- Patent-pending easy-to-size table support structure adapts to all spaces
- Steel dual-isosceles triangle design evenly distributes and supports weight throughout
- Base accommodates tabletops from 18" (D) × 48" (W) to 30" (D) × 72" (W)
- Features a minimalistic aesthetic with a below-the-surface configuration
- 28 different durable laminate options to fit your style
- Installs in less than 10 minutes with pre-installed parts
- 300 lb weight capacity warranty

SPECIFICATIONS

	Tensor Multipurpose
Height	29.67"
Leg Width	1.8"
Tabletop Thickness	1.125"
Weight Capacity Warranty	300 lb

Height range includes 1.125" tabletop.

1. Product

Product Type	Code	Price
Tabletop	3231 TBT9	Priced by Size

2. Finish

Laminate Color	Code	Price
Grade 1 Laminate		
Ankara Cherry	TL18	Priced by Size
Black	TL19	Priced by Size
Brazilian Walnut	TL20	Priced by Size
Cabinet Maple	TL21	Priced by Size
Driftwood	TL23	Priced by Size
Folkstone Grey	TL24	Priced by Size
Libretti	TL25	Priced by Size
Queenston Oak	TL26	Priced by Size
Sandalwood	TL27	Priced by Size
Walnut Amati	TL28	Priced by Size
White	TL29	Priced by Size

MULTIPURPOSE TABLETOP

TOPS AND BASES ARE SPECIFIED AND SOLD SEPARATELY.

2. Finish (Cont.)

Laminate Color	Code	Price
Grade 2 Laminate		
Classic Linen	TL17	Priced by Size
Colombian Walnut	TL55	Priced by Size
Crisp Linen	TL64	Priced by Size
Designer White	TL66	Priced by Size
Field Elm	TL13	Priced by Size
Frosty White	TL16	Priced by Size
Grey	TL62	Priced by Size
Grey Elm	TL51	Priced by Size
Kingswood Walnut	TL53	Priced by Size
Manitoba	TL56	Priced by Size
Neo Walnut	TL50	Priced by Size
Platinum	TL61	Priced by Size
Portico Teak	TL60	Priced by Size
Skyline Walnut	TL15	Priced by Size
Steel Mesh	TL59	Priced by Size
Tuscan Walnut	TL57	Priced by Size
Uptown Walnut	TL14	Priced by Size
Laminate Grade	Code	Price
Laminate Grade 1	GR1	Priced by Size
Laminate Grade 2	GR2	Priced by Size

3. Shape

Tabletop Shape	Code	Price
Rectangular Tabletop	TZ	Priced by Size

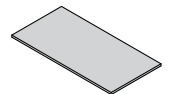

EFFECTIVE NOVEMBER 4, 2024

4. Size

Tabletop Size (D x W)	Code	Price	
Rectangular Tabletop		Grade 1	Grade 2
18" x 42"	TZ1842	\$176	\$264
18" x 48"	TZ1848	\$200	\$300
18" x 54"	TZ1854	\$225	\$338
18" x 60"	TZ1860	\$248	\$372
18" x 66"	TZ1866	\$275	\$413
18" x 72"	TZ1872	\$300	\$450
24" x 36"	TZ2436	\$196	\$294
24" x 42"	TZ2442	\$229	\$344
24" x 48"	TZ2448	\$261	\$392
24" x 54"	TZ2454	\$292	\$438
24" x 60"	TZ2460	\$324	\$486
24" x 66"	TZ2466	\$358	\$537
24" x 72"	TZ2472	\$389	\$584
30" x 36"	TZ3036	\$244	\$366
30" x 42"	TZ3042	\$285	\$428
30" x 48"	TZ3048	\$324	\$486
30" x 54"	TZ3054	\$366	\$549
30" x 60"	TZ3060	\$404	\$606
30" x 66"	TZ3066	\$445	\$668
30" x 72"	TZ3072	\$484	\$726

MULTIPURPOSE TABLETOP

TOPS AND BASES ARE SPECIFIED AND SOLD SEPARATELY.

5. Grommets

Grommet Location	Code	Price	
None	GP00	+ \$0	
Left Only	GP01	+ \$30	
Center Only	GP02	+ \$30	
Right Only	GP03	+ \$30	
Left and Center	GP04	+ \$60	
Left and Right	GP05	+ \$60	
Right and Center	GP06	+ \$60	
Left, Right and Center	GP07	+ \$90	

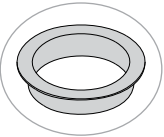

Grommet Color	Code	Price	
Black	GC01	+ \$0	
White	GC02	+ \$0	

EFFECTIVE NOVEMBER 4, 2024

1. Product

Product Type	Code	Price
Table Base	3232 TBT9	\$533

3. Base Finish

Paint Color	Code	Price
Silver	BF01	+ \$0
White	BF02	+ \$0
Black	BF03	+ \$0

3. Matching Tabletop

Tabletop Size (D x W)	Code	Price
Rectangular Tabletop	TZ	+ \$0



Tabletop Size (D x W)	Code	Price
18" x 42"	1842	+ \$0
18" x 48"	1848	+ \$47
18" x 54"	1854	+ \$47
18" x 60"	1860	+ \$47
18" x 66"	1866	+ \$47
18" x 72"	1872	+ \$73
24" x 36"	2436	+ \$0
24" x 42"	2442	+ \$0
24" x 48"	2448	+ \$47
24" x 54"	2454	+ \$47
24" x 60"	2460	+ \$47
24" x 66"	2466	+ \$47
24" x 72"	2472	+ \$73
30" x 36"	3036	+ \$0
30" x 42"	3042	+ \$0
30" x 48"	3048	+ \$47
30" x 54"	3054	+ \$47
30" x 60"	3060	+ \$47
30" x 66"	3066	+ \$47
30" x 72"	3072	+ \$73

Table bases require the specification of a tabletop size. Bases take their size from their corresponding top size.

MULTIPURPOSE TABLE BASE

TOPS AND BASES ARE SPECIFIED AND SOLD SEPARATELY.

1. Additional Options (Sold Separately)

Ganging	Code	Price
Two Pairs of Ganging Brackets	3159 XGV	\$50



Tensor

DESKING

One table does it all.

As your business grows and changes, your workspace should be able to keep up. That's why we created Tensor—one table that can adapt to your changing needs. It's the only table that can expand to support multiple top shapes and sizes with a single base. This allows you to install and reconfigure to fit any space quickly and easily.



L-Shape Desk
Chair sold separately;
see [page 132](#) for Novo.

EFFECTIVE NOVEMBER 4, 2024

Featured Models

L-SHAPE DESK :: \$1,641

30" x 72" rectangular desktop, 24" x 48" return top, grade 1 laminate, no grommets, matching bases

U-SHAPE DESK :: \$2,506

30" x 72" desktop, 24" x 72" credenza tops, no grommets, 24" x 42" bridgetop, grade 1 laminate, matching bases and bridge support

Features

- Patent-pending easy-to-size table support structure adapts to all spaces
- Steel dual-isosceles triangle design evenly distributes and supports weight throughout
- Accommodates desktops from 24" x 54"-30" x 72"; credenzas from 18" x 54"-30" x 72"; 24" x 36"-60"
- Features a minimalistic aesthetic with a below-the-surface configuration
- 28 different durable laminate options to fit your style
- Installs in less than 10 minutes with pre-installed parts
- 300 lb weight capacity warranty

SPECIFICATIONS

	Tensor Desking
Height	29.67"
Leg Width	1.8"
Tabletop Thickness	1.125"
Weight Capacity Warranty	300 lb

Height range includes 1.125" tabletop.

See the Stand-Alone Tabletop appendix on [page 623](#) for tabletop weights.



U-Shape Desk
 Chair sold separately;
 see [page 132](#) for Novo.

1. Product

Product Type	Code	Price
Desktop	3231 TBT9	Priced by Size

2. Finish

Laminate Color	Code	Price
Grade 1 Laminate		
Ankara Cherry	TL18	Priced by Size
Black	TL19	Priced by Size
Brazilian Walnut	TL20	Priced by Size
Cabinet Maple	TL21	Priced by Size
Driftwood	TL23	Priced by Size
Folkstone Grey	TL24	Priced by Size
Libretti	TL25	Priced by Size
Queenston Oak	TL26	Priced by Size
Sandalwood	TL27	Priced by Size
Walnut Amati	TL28	Priced by Size
White	TL29	Priced by Size
Grade 2 Laminate		
Classic Linen	TL17	Priced by Size
Colombian Walnut	TL55	Priced by Size
Crisp Linen	TL64	Priced by Size
Designer White	TL66	Priced by Size
Field Elm	TL13	Priced by Size
Frosty White	TL16	Priced by Size
Grey	TL62	Priced by Size
Grey Elm	TL51	Priced by Size
Kingswood Walnut	TL53	Priced by Size
Manitoba	TL56	Priced by Size
Neo Walnut	TL50	Priced by Size
Platinum	TL61	Priced by Size
Portico Teak	TL60	Priced by Size
Skyline Walnut	TL15	Priced by Size
Steel Mesh	TL59	Priced by Size
Tuscan Walnut	TL57	Priced by Size
Uptown Walnut	TL14	Priced by Size
Laminate Grade	Code	Price
Laminate Grade 1	GR1	Priced by Size
Laminate Grade 2	GR2	Priced by Size

DESKTOP AND DESK BASE FOR L-SHAPE OR U-SHAPE

TOPS AND BASES ARE SPECIFIED AND SOLD SEPARATELY.

2. Size

Desktop Size (D x W)	Code	Price
Rectangular Desktop	TZ	Priced by Size

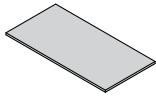

3. Size

Desktop Size (D x W)	Code	Laminate Price	
		Grade 1	Grade 2
Rectangular Desktop			
24" x 54"	2454	\$292	\$438
24" x 60"	2460	\$324	\$486
24" x 66"	2466	\$358	\$537
24" x 72"	2472	\$389	\$584
30" x 54"	3054	\$366	\$549
30" x 60"	3060	\$404	\$606
30" x 66"	3066	\$445	\$668
30" x 72"	3072	\$484	\$726

4. Grommets

Grommet Location	Code	Price
None	GP00	+ \$0
Left Only	GP01	+ \$30
Center Only	GP02	+ \$30
Right Only	GP03	+ \$30
Left and Center	GP04	+ \$60
Left and Right	GP05	+ \$60
Right and Center	GP06	+ \$60
Left, Right and Center	GP07	+ \$90
Grommet Color	Code	Price
Black	GC01	+ \$0
White	GC02	+ \$0

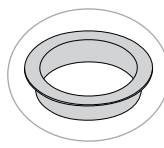

DESKTOP AND DESK BASE FOR L-SHAPE OR U-SHAPE

TOPS AND BASES ARE SPECIFIED AND SOLD SEPARATELY.

1. Desk Base

Product Type	Code	Price
Base	3232 TBT9	\$533

2. Size

Desktop Size (D x W)	Code	Price
24" x 54"	TZ2454	\$47
24" x 60"	TZ2460	\$47
24" x 66"	TZ2466	\$47
24" x 72"	TZ2472	\$73
30" x 54"	TZ3054	\$47
30" x 60"	TZ3060	\$47
30" x 66"	TZ3066	\$47
30" x 72"	TZ3072	\$73



Desk bases require the specification of a desktop size. Bases take their size from their corresponding top size.

3. Base Finish

Paint Color	Code	Price
Silver	BF01	+ \$0
White	BF02	+ \$0
Black	BF03	+ \$0

1. Product

Product Type	Code	Size
Return Top	3231 TBT9P	Priced by Size

2. Finish

Laminate Color	Code	Price
Grade 1 Laminate		
Ankara Cherry	TL18	Priced by Size
Black	TL19	Priced by Size
Brazilian Walnut	TL20	Priced by Size
Cabinet Maple	TL21	Priced by Size
Driftwood	TL23	Priced by Size
Folkstone Grey	TL24	Priced by Size
Libretti	TL25	Priced by Size
Queenston Oak	TL26	Priced by Size
Sandalwood	TL27	Priced by Size
Walnut Amati	TL28	Priced by Size
White	TL29	Priced by Size
Grade 2 Laminate		
Classic Linen	TL17	Priced by Size
Colombian Walnut	TL55	Priced by Size
Crisp Linen	TL64	Priced by Size
Designer White	TL66	Priced by Size
Field Elm	TL13	Priced by Size
Frosty White	TL16	Priced by Size
Grey	TL62	Priced by Size
Grey Elm	TL51	Priced by Size
Kingswood Walnut	TL53	Priced by Size
Manitoba	TL56	Priced by Size
Neo Walnut	TL50	Priced by Size
Platinum	TL61	Priced by Size
Portico Teak	TL60	Priced by Size
Skyline Walnut	TL15	Priced by Size
Steel Mesh	TL59	Priced by Size
Tuscan Walnut	TL57	Priced by Size
Uptown Walnut	TL14	Priced by Size
Laminate Grade	Code	Price
Laminate Grade 1	GR1	Priced by Size
Laminate Grade 2	GR2	Priced by Size

RETURN TOP FOR L-SHAPE OR U-SHAPE TOPS AND BASES ARE SPECIFIED AND SOLD SEPARATELY.

3. Shape

Return Top Size (D x W)	Code	Price
Rectangular Return Top	TN	Priced by Size

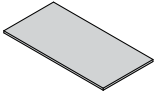

4. Size

Return Top Size (D x W)	Code	Laminate Price	
Rectangular Return Top		Grade 1	Grade 2
24" x 36"	2436	\$196	\$294
24" x 42"	2442	\$229	\$344
24" x 48"	2448	\$261	\$392
24" x 54"	2454	\$292	\$438
24" x 60"	2460	\$324	\$486

5. Grommets

Grommet Location	Code	Price
None	GPR00	+ \$0
Left Only	GPR01	+ \$30
Center Only	GPR02	+ \$30
Right Only	GPR03	+ \$30

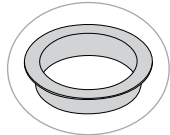

Grommet Color	Code	Price
Black	GC01	+ \$0
White	GC02	+ \$0

EFFECTIVE NOVEMBER 4, 2024

1. Product

Product Type	Code	Price
Return Base	3232 TBT9P	\$290

2. Size

Return Top Size (D x W)	Code	Price
No Return Top	TN0	+ \$0
24" x 36"	TN2436	+ \$0
24" x 42"	TN2442	+ \$0
24" x 48"	TN2448	+ \$0
24" x 54"	TN2454	+ \$74
24" x 60"	TN2460	+ \$74

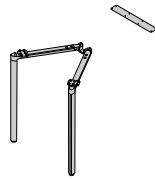

Return bases require the specification of a return top size.

3. Base Finish

Paint Color	Code	Price
Silver	BF01	\$0
White	BF02	\$0
Black	BF03	\$0

EFFECTIVE NOVEMBER 4, 2024

1. Product

Product Type	Code	Price
Bridge Top	3231 TBT10	Priced by Size

2. Finish

Laminate Color	Code	Price
Grade 1 Laminate		
Ankara Cherry	TL18	Priced by Size
Black	TL19	Priced by Size
Brazilian Walnut	TL20	Priced by Size
Cabinet Maple	TL21	Priced by Size
Driftwood	TL23	Priced by Size
Folkstone Grey	TL24	Priced by Size
Libretti	TL25	Priced by Size
Queenston Oak	TL26	Priced by Size
Sandalwood	TL27	Priced by Size
Walnut Amati	TL28	Priced by Size
White	TL29	Priced by Size
Grade 2 Laminate		
Classic Linen	TL17	Priced by Size
Colombian Walnut	TL55	Priced by Size
Crisp Linen	TL64	Priced by Size
Designer White	TL66	Priced by Size
Field Elm	TL13	Priced by Size
Frosty White	TL16	Priced by Size
Grey	TL62	Priced by Size
Grey Elm	TL51	Priced by Size
Kingswood Walnut	TL53	Priced by Size
Manitoba	TL56	Priced by Size
Neo Walnut	TL50	Priced by Size
Platinum	TL61	Priced by Size
Portico Teak	TL60	Priced by Size
Skyline Walnut	TL15	Priced by Size
Steel Mesh	TL59	Priced by Size
Tuscan Walnut	TL57	Priced by Size
Uptown Walnut	TL14	Priced by Size
Laminate Grade	Code	Price
Laminate Grade 1	GR1	Priced by Size
Laminate Grade 2	GR2	Priced by Size

BRIDGE TOP FOR U-SHAPE

TOPS AND BASES ARE SPECIFIED AND SOLD SEPARATELY.

3. Shape

Return Top Size (D x W)	Code	Price
Rectangular Bridge Top	TZ	Priced by Size

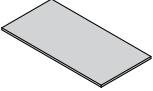

4. Size

Bridgetop Size (D x W)	Code	Price	
Rectangular Bridge Top		Grade 1	Grade 2
24" x 36"	2436	\$196	\$294
24" x 42"	2442	\$229	\$344
24" x 48"	2448	\$261	\$392
24" x 54"	2454	\$292	\$438
24" x 60"	2460	\$324	\$486

EFFECTIVE NOVEMBER 4, 2024

1. Product

Product Type	Code	Price
Bridge Support (Mending Brackets)	3232 TBT10	Priced by Size

2. Size

Bridge Top Shape	Code	Price
Rectangular Bridge Top	TZ	\$0

Bridge Top Size (D x W)	Code	Price
No Bridge Top	TN0	\$0
24" x 36"	2436	\$192
24" x 42"	2442	\$192
24" x 48"	2448	\$192
24" x 54"	2454	\$294
24" x 60"	2460	\$294

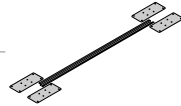

Support includes two sets of mending brackets for all bridge sizes. 54" and 60" table widths also include stiffener.

Bridge supports require the specification of a bridge top size.

1. Product

Product Type	Code	Price
Credenza Top	3231 TBT9	Priced by Size

2. Finish

Laminate Color	Code	Price
Grade 1 Laminate		
Ankara Cherry	TL18	Priced by Size
Black	TL19	Priced by Size
Brazilian Walnut	TL20	Priced by Size
Cabinet Maple	TL21	Priced by Size
Driftwood	TL23	Priced by Size
Folkstone Grey	TL24	Priced by Size
Libretti	TL25	Priced by Size
Queenston Oak	TL26	Priced by Size
Sandalwood	TL27	Priced by Size
Walnut Amati	TL28	Priced by Size
White	TL29	Priced by Size
Grade 2 Laminate		
Classic Linen	TL17	Priced by Size
Colombian Walnut	TL55	Priced by Size
Crisp Linen	TL64	Priced by Size
Designer White	TL66	Priced by Size
Field Elm	TL13	Priced by Size
Frosty White	TL16	Priced by Size
Grey	TL62	Priced by Size
Grey Elm	TL51	Priced by Size
Kingswood Walnut	TL53	Priced by Size
Manitoba	TL56	Priced by Size
Neo Walnut	TL50	Priced by Size
Platinum	TL61	Priced by Size
Portico Teak	TL60	Priced by Size
Skyline Walnut	TL15	Priced by Size
Steel Mesh	TL59	Priced by Size
Tuscan Walnut	TL57	Priced by Size
Uptown Walnut	TL14	Priced by Size
Laminate Grade	Code	Price
Laminate Grade 1	GR1	Priced by Size
Laminate Grade 2	GR2	Priced by Size

CREENZA TOP FOR U-SHAPE

TOPS AND BASES ARE SPECIFIED AND SOLD SEPARATELY.

3. Shape

Credenza Shape	Code	Price
Rectangular Credenza Top	TZ	Priced by Size

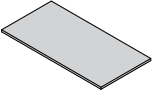

4. Size

Credenza Top Size (D x W)	Code	Laminate Price	
Rectangular Bridge Top		Grade 1	Grade 2
18" x 54"	1854	\$225	\$338
18" x 60"	1860	\$248	\$372
18" x 66"	1866	\$275	\$413
18" x 72"	1872	\$300	\$450
24" x 54"	2454	\$292	\$438
24" x 60"	2460	\$324	\$486
24" x 66"	2466	\$358	\$537
24" x 72"	2472	\$389	\$584
30" x 54"	3054	\$366	\$549
30" x 60"	3060	\$404	\$606
30" x 66"	3066	\$445	\$668
30" x 72"	3072	\$484	\$726

5. Grommets

Grommet Location	Code	Price
No Grommets	GP00	+ \$0
Left Only	GP01	+ \$30
Center Only	GP02	+ \$30
Right Only	GP03	+ \$30
Left and Center	GP04	+ \$60
Left and Right	GP05	+ \$60
Right and Center	GP06	+ \$60
Left, Right and Center	GP07	+ \$90
Grommet Color	Code	Price
Black	GC01	+ \$0
White	GC02	+ \$0

EFFECTIVE NOVEMBER 4, 2024

1. Product

Product Type	Code	Price
Credenza Base	3232 TBT9	\$533

2. Base Finish

Paint Color	Code	Price
Silver	BF01	+ \$0
White	BF02	+ \$0
Black	BF03	+ \$0

3. Size

Credenza Top Size (D x W)	Code	Price
18" x 54"	TZ1854	+ \$47
18" x 60"	TZ1860	+ \$47
18" x 66"	TZ1866	+ \$47
18" x 72"	TZ1872	+ \$73
24" x 54"	TZ2454	+ \$47
24" x 60"	TZ2460	+ \$47
24" x 66"	TZ2466	+ \$47
24" x 72"	TZ2472	+ \$73
30" x 54"	TZ3054	+ \$47
30" x 60"	TZ3060	+ \$47
30" x 66"	TZ3066	+ \$47
30" x 72"	TZ3072	+ \$73

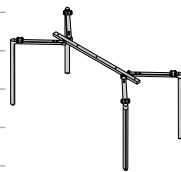

Credenza bases require the specification of a credenza top size. Bases take their size from their corresponding top size.

Uni

LAPTOP TABLE

Uni-quely Uni-versal.

Light in weight and not on convenience.

Uni goes anywhere you need it—and with any lounge collection we have. Laptops, notebooks, coffee mugs and more, it's the perfect seating sidekick for your shared and in-between spaces.



Silver
Featured with a Skyline Walnut laminate.

EFFECTIVE NOVEMBER 4, 2024

Featured Models

CHARCOAL :: \$522

Rectangular laptop table, charcoal base, laminate top

SILVER :: \$522

Rectangular laptop table, charcoal base, laminate top

Features

- Ample surface provides plenty of room to work
- Sleek laminate top features a low-profile knife edge
- Easy-grip finger groove makes moving easy
- Durable base is ultra slim for safer high-traffic areas
- Multi-surface glides enhance mobility while protecting floors
- 100 lb weight capacity warranty

1. Product

Model	Code	Price	
Rectangular Laptop Table	3260 TT9	\$522	

2. Base

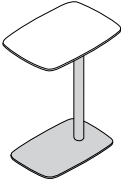
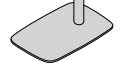
Base Color	Code	Price	
Charcoal	BF04	+ \$0	
Silver	BF01	+ \$0	

3. Table Top

Material	Code	Price	
Laminate	TM3	+ \$0	
Material	Code	Price	
Field Elm	TL13	+ \$0	
Uptown Walnut	TL14	+ \$0	
Skyline Walnut	TL15	+ \$0	
Frosty White	TL16	+ \$0	

LAPTOP TABLE

4. Packaging

Packaging	Code	Price	
Final Assembly Required	P3	+ \$0	

SPECIFICATIONS

Model: 3260 TT9 Laptop Table	
Dimensions	
Overall Height	25.5"
Tabletop Depth	14"
Tabletop Width	20"
Tabletop Thickness	0.75"
Base Depth	11.6"
Base Width	17.6"
Base Thickness	0.25"
Weight and Capacity	
Weight	23.63 lb
Weight Capacity Warranty	100 lb



Charcoal
Featured with a Uptown Walnut laminate.

Benching

FIXED | SINGLE-SIDED | BACK-TO-BACK

HiQ

HEIGHT-ADJUSTABLE BENCHING

Elevate your spaces—literally

HiQ™ is our brand-new height-adjustable total benching solution. This collection lets you take productivity to a higher level with the push of a button, promoting healthier environments through essential ergonomics, connectivity and workspace division. And with a vast lineup of options and add-ons, there's no limit to how you can make it fit anywhere.



6-Seat With Screen
Chairs and storage sold separately.
See [page 132](#) for Novo and [page 614](#) for Mobile pedestal.

EFFECTIVE NOVEMBER 4, 2024

Featured Models

BASIC 4-SEAT :: \$7,376

Four seat back-to-back base, 70" × 23" bench tops with no grommets and a grade 1 laminate, vertical wire manager, no end panels, no wire troughs, 72" power infeed, conduit, two duplex receptacles per seat

6-SEAT WITH SCREEN :: \$14,244

Six seat back-to-back base, 70" × 23" bench tops with no grommets and a grade 2 laminate, vertical wire manager, no end panels, no wire troughs, 72" power infeed, conduit, three duplex receptacles per seat, 18" × 72" screens in a grade 2 textile

Features

- Take ergonomics to a new level with push-button height adjustability (28"–47")
- Add a little privacy in shared setups with any Sector or Motif screen as well as optional laminate gallery panels
- Build powerful places of productivity with a robust roster of workstation accessories
- Clear the clutter using cable, data and power management enhancements (beam or trough)
- Customize buildouts to fit your corporate, healthcare and education environments
- Standard control includes four programmable positions and features integrated gyroscopic anti-collision sensor
- Maximize power and data access with up to six duplexes per workstation and capacity for up to 48 CAT6 cables
- Make setup seamless with "above-beam" power and data installation
- Robust steel construction exceeds BIFMA standards for safety and reliability
- UL Certified (UL932)

BENCH TOP

TOPS AND BASES ARE SPECIFIED AND SOLD SEPARATELY.



SPECIFICATIONS

	3291/3292 Height-Adjustable Benching
Total Depth of Benches	50" (24" Top) 62" (30" Top)
Space Between Back-to-Back Benches	4"
Bench Top Thickness	1.125"
Side-to-Side Gap (Mid-Run)	2"
Height Without Bench Top	27.5"–46.4"
Height From Floor to Underside of Crossbeam	17.29"
Distance Between Legs (Width) (Inside-Edge-to-Inside-Edge End)	37.4" (48" Top) 49.4" (60" Top) 61.4" (72" Top)
Distance Between Legs (Width) (Outside-Edge-to-Outside-Edge)	42.9" (48" Top) 54.9" (60" Top) 66.9" (72" Top)
Leg (sq)	2.75"
Crossbeam (H x W)	3.2" x 2.6"
Gauge of Steel	12
Active Power Consumption	190–200 W
Standby Power Consumption	0.1 W
Travel Height	19.7"
Speed (Per Second)	1.2"
Weight Capacity (Per Seat)	265 lb



Standard 4-Seat
Featured with White laminate.

1. Product

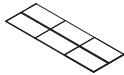
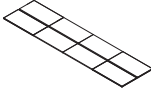
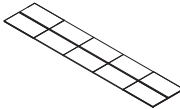
Product Type	Code	Price	
HiQ Bench Top	3291	Priced by Size	
Orientation	Code	Price	
Back-to-Back	BB	Priced by Size	
Seated Positions	Code	Price	
Back-to-Back			
Two Seats	SP2	Priced by Size	
Four Seats	SP4	Priced by Size	
Six Seats	SP6	Priced by Size	
Eight Seats	SP8	Priced by Size	
Ten Seats	SP10	Priced by Size	
Matching Base Style	Code	Price	
2-Stage T-Leg	TBT5	Priced by Size	

2. Finish

Laminate	Code	Price	
Grade 1 Laminate			
Ankara Cherry	TL18	Priced by Size	
Black	TL19	Priced by Size	
Brazilian Walnut	TL20	Priced by Size	
Cabinet Maple	TL21	Priced by Size	
Driftwood	TL23	Priced by Size	
Folkstone Grey	TL24	Priced by Size	
Libretti	TL25	Priced by Size	
Queenston Oak	TL26	Priced by Size	
Sandalwood	TL27	Priced by Size	

BENCH TOP

TOPS AND BASES ARE SPECIFIED AND SOLD SEPARATELY.

3. Top Finish

Laminate	Code	Price	
Walnut Amati	TL28	Priced by Size	
White	TL29	Priced by Size	
Grade 2 Laminate			
Classic Linen	TL17	Priced by Size	
Colombian Walnut	TL55	Priced by Size	
Crisp Linen	TL64	Priced by Size	
Designer White	TL66	Priced by Size	
Field Elm	TL13	Priced by Size	
Frosty White	TL16	Priced by Size	
Grey	TL62	Priced by Size	
Grey Elm	TL51	Priced by Size	
Kingswood Walnut	TL53	Priced by Size	
Manitoba	TL56	Priced by Size	
Neo Walnut	TL50	Priced by Size	
Platinum	TL61	Priced by Size	
Portico Teak	TL60	Priced by Size	
Skyline Walnut	TL15	Priced by Size	
Steel Mesh	TL59	Priced by Size	
Tuscan Walnut	TL57	Priced by Size	
Uptown Walnut	TL14	Priced by Size	
Laminate Grade	Code	Price	
Laminate Grade 1	GR1	Priced by Size	
Laminate Grade 2	GR2	Priced by Size	

3. Shape

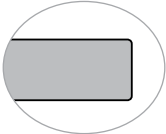
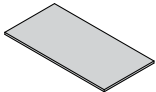
Edge Style	Code	Price	
Flat Edge	TE5	Priced by Size	
Bench Top Shape	Code	Price	
Rectangular Bench Top	TZ	Priced by Size	

4. Size

Depth x Width	Code	Laminate Price	
Two Seat (BB)		Grade 1	Grade 2
23" x 46"	2346	\$522	\$784
23" x 58"	2358	\$648	\$972
23" x 70"	2370	\$778	\$1,168
29" x 46"	2946	\$648	\$972
29" x 58"	2958	\$808	\$1,212
29" x 70"	2970	\$968	\$1,452
Four Seats (BB)		Grade 1	Grade 2
23" x 46"	2346	\$1,044	\$1,568
23" x 58"	2358	\$1,296	\$1,944
23" x 70"	2370	\$1,556	\$2,336
29" x 46"	2946	\$1,296	\$1,944
29" x 58"	2958	\$1,616	\$2,424
29" x 70"	2970	\$1,936	\$2,904
Six Seats (BB)		Grade 1	Grade 2
23" x 46"	2346	\$1,566	\$2,352
23" x 58"	2358	\$1,944	\$2,916
23" x 70"	2370	\$2,334	\$3,504
29" x 46"	2946	\$1,944	\$2,916
29" x 58"	2958	\$2,424	\$3,636
29" x 70"	2970	\$2,904	\$4,356
Eight Seats (BB)		Grade 1	Grade 2
23" x 46"	2346	\$2,088	\$3,136
23" x 58"	2358	\$2,592	\$3,888
23" x 70"	2370	\$3,112	\$4,672
29" x 46"	2946	\$2,592	\$3,888
29" x 58"	2958	\$3,232	\$4,848
29" x 70"	2970	\$3,872	\$5,808
Ten Seats (BB)		Grade 1	Grade 2
23" x 46"	2346	\$2,610	\$3,920
23" x 58"	2358	\$3,240	\$4,860
23" x 70"	2370	\$3,890	\$5,840
29" x 46"	2946	\$3,240	\$4,860
29" x 58"	2958	\$4,040	\$6,060
29" x 70"	2970	\$4,840	\$7,260



BENCH TOP

TOPS AND BASES ARE SPECIFIED AND SOLD SEPARATELY.

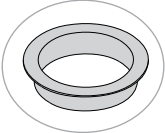
5. Grommets

Grommet Location	Code	Price	
None	GP00	+ \$0	
Two Seat (BB)			
Left	GP01	+ \$60	
Right	GP03	+ \$60	
Left and Right	GP05	+ \$120	
Four Seats (BB)			
Left	GP01	+ \$120	
Right	GP03	+ \$120	
Left and Right	GP05	+ \$240	
Six Seats (BB)			
Left	GP01	+ \$180	
Right	GP03	+ \$180	
Left and Right	GP05	+ \$360	
Eight Seats (BB)			
Left	GP01	+ \$240	
Right	GP03	+ \$240	
Left and Right	GP05	+ \$480	
Ten Seats (BB)			
Left	GP01	+ \$300	
Right	GP03	+ \$300	
Left and Right	GP05	+ \$600	
Grommet Color	Code	Price	
Black	GC01	+ \$0	
White	GC02	+ \$0	

1. Product

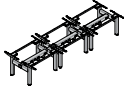
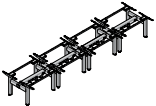
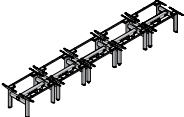
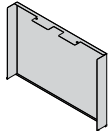
Product Type	Code	Price	
HA Bench Bases	3292	Priced by Style	
Orientation	Code	Price	
Back-to-Back	BB	Priced by Style	
Seated Postions	Code	Price	
Back-to-Back			
Two Seats	SP2	Priced by Style	
Four Seats	SP4	Priced by Style	
Six Seats	SP6	Priced by Style	
Eight Seats	SP8	Priced by Style	
Ten Seats	SP10	Priced by Style	
Base Style	Code	Price	
2-Stage Height-Adjustable			
Two Seats (BB)	TBT5	\$3,210	
Four Seats (BB)	TBT5	\$6,420	
Six Seats (BB)	TBT5	\$9,630	
Eight Seats (BB)	TBT5	\$12,840	
Ten Seats (BB)	TBT5	\$16,050	
Optional Base Components	Code	Price	
No End Panels	FEK00	+ \$0	
End Panel Set	FEK02	+ \$348	

BENCH BASE

TOPS AND BASES ARE SPECIFIED AND SOLD SEPARATELY.

2. Matching Tabletop

Tabletop Shape	Code	Price	
Rectangular	TZ	+ \$0	
Tabletop Size			
23" x 46"	2346	+ \$0	
23" x 58"	2358	+ \$0	
23" x 70"	2370	+ \$0	
29" x 46"	2946	+ \$0	
29" x 58"	2958	+ \$0	
29" x 70"	2970	+ \$0	

Bench bases require the specification of a bench top size. Bases take their size from their corresponding top size.

3. Hand Control

Hand Control Style	Code	Price	
Programmable Controller	HC02	+ \$0	

4. Cable Management

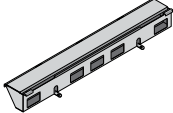
Cable Trough	Code	Price	
Cable Trough	CT00	+\$0	
No Cable Trough, Two Seats (BB)	CT01	- \$300	
No Cable Trough, Four Seats (BB)	CT01	- \$600	
No Cable Trough, Six Seats (BB)	CT01	- \$900	
No Cable Trough, Eight Seats (BB)	CT01	- \$1,200	
No Cable Trough, Ten Seats (BB)	CT01	- \$1,500	

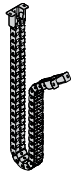
Vertical Wire Manager	Code	Price	
Vertical Wire Manager	VC01 VCC03	+ \$0	
No Vertical Cable Carrier, Two Seats (BB)	VC00	- \$210	
No Vertical Cable Carrier, Four Seats (BB)	VC00	- \$420	
No Vertical Cable Carrier, Six Seats (BB)	VC00	- \$630	
No Vertical Cable Carrier, Eight Seats (BB)	VC00	- \$840	
No Vertical Cable Carrier, Ten Seats (BB)	VC00	- \$1,050	

EFFECTIVE NOVEMBER 4, 2024

4. Power

Power Infeed	Code	Price
No Power Infeed	NPIF	- \$147
72" Power Infeed, Conduit	PIC72	+ \$0
72" Power Infeed, Liquidtight	PIL72	+ \$12
144" Power Infeed, Conduit	PIC144	+ \$47
144" Power Infeed, Liquidtight	PIL144	+ \$59

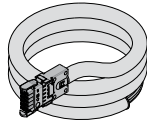

Vertical Cable Carrier	Code	Price
No Duplex		
No Duplex Receptacles, Two Seats (BB)	NDUP	- \$158
No Duplex Receptacles, Four Seats (BB)	NDUP	- \$316
No Duplex Receptacles, Six Seats (BB)	NDUP	- \$474
No Duplex Receptacles, Eight Seats (BB)	NDUP	- \$632
No Duplex Receptacles, Ten Seats (BB)	NDUP	- \$790

Double Duplex		
Double Duplex Receptacles	SDUP	+ \$0

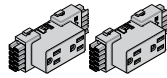

Triple Duplex		
Triple Duplex Receptacles, Two Seats (BB)	SDUP3	+ \$80
Triple Duplex Receptacles, Four Seats (BB)	SDUP3	+ \$160
Triple Duplex Receptacles, Six Seats (BB)	SDUP3	+ \$240
Triple Duplex Receptacles, Eight Seats (BB)	SDUP3	+ \$320
Triple Duplex Receptacles, Ten Seats (BB)	SDUP3	+ \$400

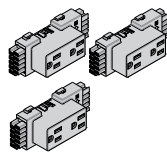

5. Base Finish

Paint Color	Code	Price
Silver	BF01	+ \$0
White	BF02	+ \$0
Black	BF03	+ \$0

SCREENS

1. Product

Product Type	Code	Price
HiQ Center Screen	3293	Priced By Screen Size

2. Matching Benching

Orientation	Code	Price
Back-to-Back	BB	Priced By Screen Size

Seated Positions	Code	Price
Back-to-Back		

Two Seats	SP2	Priced by Screen Size
Four Seats	SP4	Priced by Screen Size
Six Seats	SP6	Priced by Screen Size
Eight Seats	SP8	Priced by Screen Size
Ten Seats	SP10	Priced by Screen Size

Bench Top Size	Code	Price
None	TZ0	Priced by Screen Size
23" x 46"	TZ2346	Priced by Screen Size
23" x 58"	TZ2358	Priced by Screen Size
23" x 70"	TZ2370	Priced by Screen Size
29" x 46"	TZ2946	Priced by Screen Size
29" x 58"	TZ2958	Priced by Screen Size
29" x 70"	TZ2970	Priced by Screen Size

Screens require the specification of a bench top size.

4. Material

Material Type	Code	Price
Markerboard	DT301	Price Below
Fabric/Vinyl	DT701	Priced by Grade

Material Grade	Code	18" (H) Price	24" (H) Price	30" (H) Price	36" (H) Price
48" Wide Side Screens, Two-Seat Back-to-Back		18" x 48"	24" x 48"	30" x 48"	36" x 48"
Markerboard Price		\$316	\$421	\$509	\$636
Fabric/Vinyl Base Price		\$446	\$483	\$610	\$763
Fabric/Vinyl Grade 1	FG1/VG1	+ \$0	+ \$0	+ \$0	+ \$0
Fabric/Vinyl Grade 2	FG2/VG2	+ \$17	+ \$34	+ \$34	+ \$42
Fabric/Vinyl Grade 3	FG3/VG3	+ \$45	+ \$90	+ \$90	+ \$112
Fabric/Vinyl Grade 4	FG4/VG4	+ \$79	+ \$158	+ \$158	+ \$196
Fabric/Vinyl Grade 5	FG5/VG5	+ \$136	+ \$272	+ \$272	+ \$336

3. Size

Screen Size (H" x W")	Code	Price
Two-Seat Back-to-Back		
18" x 48"	DS1848	Priced by Material and Grade
24" x 48"	DS2448	Priced by Material and Grade
30" x 48"	DS3048	Priced by Material and Grade
36" x 48"	DS3648	Priced by Material and Grade
18" x 60"	DS1860	Priced by Material and Grade
24" x 60"	DS2460	Priced by Material and Grade
30" x 60"	DS3060	Priced by Material and Grade
36" x 60"	DS3660	Priced by Material and Grade
18" x 72"	DS1872	Priced by Material and Grade
24" x 72"	DS2472	Priced by Material and Grade
30" x 72"	DS3072	Priced by Material and Grade
36" x 72"	DS3672	Priced by Material and Grade

EFFECTIVE NOVEMBER 4, 2024

4. Material (Cont.)

Material Grade	Code	18" (H) Price	24" (H) Price	30" (H) Price	36" (H) Price
48" Wide Side Screens, Four-Seat Back-to-Back		18" x 48"	24" x 48"	30" x 48"	36" x 48"
Markerboard Price		\$632	\$842	\$1,018	\$1,273
Fabric/Vinyl Base Price		\$892	\$966	\$1,220	\$1,525
Fabric/Vinyl Grade 1	FG1/VG1	+ \$0	+ \$0	+ \$0	+ \$0
Fabric/Vinyl Grade 2	FG2/VG2	+ \$34	+ \$68	+ \$68	+ \$84
Fabric/Vinyl Grade 3	FG3/VG3	+ \$90	+ \$180	+ \$180	+ \$224
Fabric/Vinyl Grade 4	FG4/VG4	+ \$158	+ \$316	+ \$316	+ \$392
Fabric/Vinyl Grade 5	FG5/VG5	+ \$272	+ \$544	+ \$544	+ \$672
48" Wide Side Screens, Six-Seat Back-to-Back		18" x 48"	24" x 48"	30" x 48"	36" x 48"
Markerboard Price		\$948	\$1,263	\$1,527	\$1,909
Fabric/Vinyl Base Price		\$1,338	\$1,449	\$1,830	\$2,288
Fabric/Vinyl Grade 1	FG1/VG1	+ \$0	+ \$0	+ \$0	+ \$0
Fabric/Vinyl Grade 2	FG2/VG2	+ \$51	+ \$102	+ \$102	+ \$126
Fabric/Vinyl Grade 3	FG3/VG3	+ \$135	+ \$270	+ \$270	+ \$336
Fabric/Vinyl Grade 4	FG4/VG4	+ \$237	+ \$474	+ \$474	+ \$588
Fabric/Vinyl Grade 5	FG5/VG5	+ \$408	+ \$816	+ \$816	+ \$1,008
48" Wide Side Screens, Eight-Seat Back-to-Back		18" x 48"	24" x 48"	30" x 48"	36" x 48"
Markerboard Price		\$1,264	\$1,684	\$2,036	\$2,545
Fabric/Vinyl Base Price		\$1,784	\$1,932	\$2,440	\$3,050
Fabric/Vinyl Grade 1	FG1/VG1	+ \$0	+ \$0	+ \$0	+ \$0
Fabric/Vinyl Grade 2	FG2/VG2	+ \$68	+ \$136	+ \$136	+ \$168
Fabric/Vinyl Grade 3	FG3/VG3	+ \$180	+ \$360	+ \$360	+ \$448
Fabric/Vinyl Grade 4	FG4/VG4	+ \$316	+ \$632	+ \$632	+ \$784
Fabric/Vinyl Grade 5	FG5/VG5	+ \$544	+ \$1,088	+ \$1,088	+ \$1,344
48" Wide Side Screens, Ten-Seat Back-to-Back		18" x 48"	24" x 48"	30" x 48"	36" x 48"
Markerboard Price		\$1,580	\$2,105	\$2,545	\$3,181
Fabric/Vinyl Base Price		\$2,230	\$2,415	\$3,050	\$3,813
Fabric/Vinyl Grade 1	FG1/VG1	+ \$0	+ \$0	+ \$0	+ \$0
Fabric/Vinyl Grade 2	FG2/VG2	+ \$85	+ \$170	+ \$170	+ \$210
Fabric/Vinyl Grade 3	FG3/VG3	+ \$225	+ \$450	+ \$450	+ \$560
Fabric/Vinyl Grade 4	FG4/VG4	+ \$395	+ \$790	+ \$790	+ \$980
Fabric/Vinyl Grade 5	FG5/VG5	+ \$680	+ \$1,360	+ \$1,360	+ \$5,493
60" Wide Screens, Two-Seat Back-to-Back		18" x 60"	24" x 60"	30" x 60"	36" x 60"
Markerboard Price		\$393	\$525	\$635	\$794
Fabric/Vinyl Base Price		\$502	\$593	\$717	\$896
Fabric/Vinyl Grade 1	FG1/VG1	+ \$0	+ \$0	+ \$0	+ \$0
Fabric/Vinyl Grade 2	FG2/VG2	+ \$21	+ \$42	+ \$50	+ \$50
Fabric/Vinyl Grade 3	FG3/VG3	+ \$56	+ \$112	+ \$133	+ \$133
Fabric/Vinyl Grade 4	FG4/VG4	+ \$98	+ \$196	+ \$233	+ \$233
Fabric/Vinyl Grade 5	FG5/VG5	+ \$168	+ \$336	+ \$400	+ \$400

EFFECTIVE NOVEMBER 4, 2024

4. Material (Cont.)

Material Grade	Code	18" (H) Price	24" (H) Price	30" (H) Price	36" (H) Price
60" Wide Screens, Four-Seat Back-to-Back		18" x 60"	24" x 60"	30" x 60"	36" x 60"
Markerboard Price		\$786	\$1,050	\$1,270	\$1,588
Fabric/Vinyl Base Price		\$1,004	\$1,186	\$1,434	\$1,793
Fabric/Vinyl Grade 1	FG1/VG1	+ \$0	+ \$0	+ \$0	+ \$0
Fabric/Vinyl Grade 2	FG2/VG2	+ \$42	+ \$84	+ \$100	+ \$100
Fabric/Vinyl Grade 3	FG3/VG3	+ \$112	+ \$224	+ \$266	+ \$266
Fabric/Vinyl Grade 4	FG4/VG4	+ \$196	+ \$392	+ \$466	+ \$466
Fabric/Vinyl Grade 5	FG5/VG5	+ \$336	+ \$672	+ \$800	+ \$800
60" Wide Screens, Six-Seat Back-to-Back		18" x 60"	24" x 60"	30" x 60"	36" x 60"
Markerboard Price		\$1,179	\$1,575	\$1,905	\$2,381
Fabric/Vinyl Base Price		\$1,506	\$1,779	\$2,151	\$2,689
Fabric/Vinyl Grade 1	FG1/VG1	+ \$0	+ \$0	+ \$0	+ \$0
Fabric/Vinyl Grade 2	FG2/VG2	+ \$63	+ \$126	+ \$150	+ \$150
Fabric/Vinyl Grade 3	FG3/VG3	+ \$168	+ \$336	+ \$399	+ \$399
Fabric/Vinyl Grade 4	FG4/VG4	+ \$294	+ \$588	+ \$699	+ \$699
Fabric/Vinyl Grade 5	FG5/VG5	+ \$504	+ \$1,008	+ \$1,200	+ \$1,200
60" Wide Screens, Eight-Seat Back-to-Back		18" x 60"	24" x 60"	30" x 60"	36" x 60"
Markerboard Price		\$1,572	\$2,100	\$2,540	\$3,175
Fabric/Vinyl Base Price		\$2,008	\$2,372	\$2,868	\$3,585
Fabric/Vinyl Grade 1	FG1/VG1	+ \$0	+ \$0	+ \$0	+ \$0
Fabric/Vinyl Grade 2	FG2/VG2	+ \$84	+ \$168	+ \$200	+ \$200
Fabric/Vinyl Grade 3	FG3/VG3	+ \$224	+ \$448	+ \$532	+ \$532
Fabric/Vinyl Grade 4	FG4/VG4	+ \$392	+ \$784	+ \$932	+ \$932
Fabric/Vinyl Grade 5	FG5/VG5	+ \$672	+ \$1,344	+ \$1,600	+ \$1,600
60" Wide Screens, Ten-Seat Back-to-Back		18" x 60"	24" x 60"	30" x 60"	36" x 60"
Markerboard Price		\$1,965	\$2,625	\$3,175	\$3,969
Fabric/Vinyl Base Price		\$2,510	\$2,965	\$3,585	\$4,481
Fabric/Vinyl Grade 1	FG1/VG1	+ \$0	+ \$0	+ \$0	+ \$0
Fabric/Vinyl Grade 2	FG2/VG2	+ \$105	+ \$210	+ \$250	+ \$250
Fabric/Vinyl Grade 3	FG3/VG3	+ \$280	+ \$560	+ \$665	\$665
Fabric/Vinyl Grade 4	FG4/VG4	+ \$490	+ \$980	+ \$1,165	+ \$1,165
Fabric/Vinyl Grade 5	FG5/VG5	+ \$840	+ \$1,680	+ \$2,000	+ \$2,000
72" Wide Screens, Two-Seat Back-to-Back		18" x 72"	24" x 72"	30" x 72"	36" x 72"
Markerboard Price		\$475	\$629	\$761	\$951
Fabric/Vinyl Base Price		\$565	\$731	\$757	\$946
Fabric/Vinyl Grade 1	FG1/VG1	+ \$0	+ \$0	+ \$0	+ \$0
Fabric/Vinyl Grade 2	FG2/VG2	+ \$25	+ \$50	+ \$50	+ \$50
Fabric/Vinyl Grade 3	FG3/VG3	+ \$66	+ \$133	+ \$133	+ \$133
Fabric/Vinyl Grade 4	FG4/VG4	+ \$116	+ \$233	+ \$233	+ \$233
Fabric/Vinyl Grade 5	FG5/VG5	+ \$200	+ \$400	+ \$400	+ \$400

EFFECTIVE NOVEMBER 4, 2024

4. Material (Cont.)

Material Grade	Code	18" (H) Price	24" (H) Price	30" (H) Price	36" (H) Price
72" Wide Screens, Four-Seat Back-to-Back		18" x 72"	24" x 72"	30" x 72"	36" x 72"
Markerboard Price		\$950	\$1,258	\$1,522	\$1,903
Fabric/Vinyl Base Price		\$1,130	\$1,462	\$1,514	\$1,893
Fabric/Vinyl Grade 1	FG1/VG1	+ \$0	+ \$0	+ \$0	+ \$0
Fabric/Vinyl Grade 2	FG2/VG2	+ \$50	+ \$100	+ \$100	+ \$100
Fabric/Vinyl Grade 3	FG3/VG3	+ \$132	+ \$266	+ \$266	+ \$266
Fabric/Vinyl Grade 4	FG4/VG4	+ \$232	+ \$466	+ \$466	+ \$466
Fabric/Vinyl Grade 5	FG5/VG5	+ \$400	+ \$800	+ \$800	+ \$800
72" Wide Screens, Six-Seat Back-to-Back		18" x 72"	24" x 72"	30" x 72"	36" x 72"
Markerboard Price		\$1,425	\$1,887	\$2,283	\$2,854
Fabric/Vinyl Base Price		\$1,695	\$2,193	\$2,271	\$2,839
Fabric/Vinyl Grade 1	FG1/VG1	+ \$0	+ \$0	+ \$0	+ \$0
Fabric/Vinyl Grade 2	FG2/VG2	+ \$75	+ \$150	+ \$150	+ \$150
Fabric/Vinyl Grade 3	FG3/VG3	+ \$198	+ \$399	+ \$399	+ \$399
Fabric/Vinyl Grade 4	FG4/VG4	+ \$348	+ \$699	+ \$699	+ \$699
Fabric/Vinyl Grade 5	FG5/VG5	+ \$600	+ \$1,200	+ \$1,200	+ \$1,200
72" Wide Screens, Eight-Seat Back-to-Back		18" x 72"	24" x 72"	30" x 72"	36" x 72"
Markerboard Price		\$1,900	\$2,516	\$3,044	\$3,805
Fabric/Vinyl Base Price		\$2,260	\$2,924	\$3,028	\$3,785
Fabric/Vinyl Grade 1	FG1/VG1	+ \$0	+ \$0	+ \$0	+ \$0
Fabric/Vinyl Grade 2	FG2/VG2	+ \$100	+ \$200	+ \$200	+ \$200
Fabric/Vinyl Grade 3	FG3/VG3	+ \$264	+ \$532	+ \$532	+ \$532
Fabric/Vinyl Grade 4	FG4/VG4	+ \$464	+ \$932	+ \$932	+ \$932
Fabric/Vinyl Grade 5	FG5/VG5	+ \$800	+ \$1,600	+ \$1,600	+ \$1,600
72" Wide Screens, Ten-Seat Back-to-Back		18" x 72"	24" x 72"	30" x 72"	36" x 72"
Markerboard Price		\$2,375	\$3,145	\$3,805	\$4,756
Fabric/Vinyl Base Price		\$2,825	\$3,655	\$3,785	\$4,731
Fabric/Vinyl Grade 1	FG1/VG1	+ \$0	+ \$0	+ \$0	+ \$0
Fabric/Vinyl Grade 2	FG2/VG2	+ \$125	+ \$250	+ \$250	+ \$250
Fabric/Vinyl Grade 3	FG3/VG3	+ \$330	+ \$665	+ \$665	+ \$665
Fabric/Vinyl Grade 4	FG4/VG4	+ \$580	+ \$1,165	+ \$1,165	+ \$1,165
Fabric/Vinyl Grade 5	FG5/VG5	+ \$1,000	+ \$2,000	+ \$2,000	+ \$2,000

Please reference the [Textile Reference Guide](#) for information on approved textiles for Motif products.

1. Product

Product Category	Code	Price
Stand-Alone HiQ Accessory	3299	Priced by Size
Product Type	Code	Price
Boundary Screen	ATC10	Priced by Size

2. Size

Screen Size (H x W)	Code	Price
For Benches Without Center Screens		
29" x 51"	BS2951	\$529
29" x 63"	BS2963	\$615
For Benches With 18" Center Screens		
42" x 51"	BS4251	\$675
42" x 63"	BS4263	\$750
For Benches With 24" Center Screens		
48" x 51"	BS4851	\$703
48" x 63"	BS4863	\$825
For Benches With 30" Center Screens		
54" x 51"	BS5451	\$827
54" x 63"	BS5463	\$1,021
For Benches With 36" Center Screens		
60" x 51"	BS6051	\$918
60" x 63"	BS6063	\$1,134

Price is for a single boundary screen, not a pair.

BOUNDARY SCREENS

3. Material

Screen Material Type	Code	Price
Laminate	DT501	+\$0
Laminate Grade	Code	Price
Grade 1	GR1	+\$0
Laminate Finish	Code	Price
Ankara Cherry	TL18	+\$0
Black	TL19	+\$0
Brazilian Walnut	TL20	+\$0
Cabinet Maple	TL21	+\$0
Driftwood	TL23	+\$0
Folkstone Grey	TL24	+\$0
Libretti	TL25	+\$0
Queenston Oak	TL26	+\$0
Sandlewood	TL27	+\$0
Walnut Amati	TL28	+\$0
White	TL29	+\$0

4. Finish

Paint Color for Brackets	Code	Price
Silver	BF01	+\$0
White	BF02	+\$0
Black	BF03	+\$0

Cable Trough

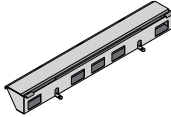
Product Category	Code	Price	Price
Stand-Alone HiQ Accessory	3299	Priced By Product Type	
Product Type	Code	Price	
Single Cable Trough	ATC09 CT01	\$150	
Tabletop Width	Code	Price	
46"	TRL46	+ \$0	
58"	TRL58	+ \$0	
70"	TRL70	+ \$0	
Product Color	Code		Price
Silver	BF01	+ \$0	
White	BF02	+ \$0	
Black	BF03	+ \$0	

Vertical Cable Carrier

Product Category	Code	Price	
Stand-Alone HiQ Accessory	3299	Priced By Product Type	
Product Type	Code	Price	
Vertical Wire Manager	ATC01 VC01	\$105	
Product Color	Code	Price	
Black	VCC03	+ \$0	

STAND-ALONE ACCESSORIES: POWER AND CABLE MANAGEMENT

Duplex Receptacle

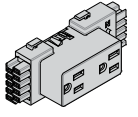
Product Category	Code	Price	
Stand-Alone HiQ Accessory	3299	Priced By Product Type	
Product Type	Code	Price	
Duplex Receptacle	ATC04	\$40	
Circuits	Code	Price	
Circuit 1 (3+1, 2+2)	DC1	+ \$0	
Circuit 2 (3+1, 2+2)	DC2	+ \$0	
Circuit 3 (3+1)	DC3	+ \$0	
Circuit 3 (2+2)	DC3D	+ \$0	
Circuit 4 (3+1, 2+2)	DC4	+ \$0	
Controlled			
Circuit 1 (3+1, 2+2)	DC1C	+ \$7	
Circuit 2 (3+1, 2+2)	DC2C	+ \$7	
Circuit 3 (3+1)	DC3C	+ \$7	
Circuit 3 (2+2)	DC3CD	+ \$7	
Circuit 4 (3+1, 2+2)	DC4C	+ \$7	

Power Infeed

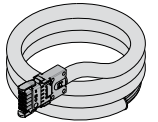
Product Category	Code	Price	
Stand-Alone HiQ Accessory	3299	Priced By Product Type	
Product Type	Code	Price	
Power Infeed	ATC05	Priced by Conduit Style	
Conduit Style	Code	Price	
72" Conduit	PIC72	\$147	
72" Liquidtight	PIL72	\$159	
144" Conduit	PIC144	\$194	
144" Liquidtight	PIL144	\$206	

Power Jumper

Product Category	Code	Price	
Stand-Alone HiQ Accessory	3299	Priced By Product Type	
Product Type	Code	Price	
Power Jumper	ATC12	Priced by Conduit Style	

Prise

BENCHING TYPICALS

One size really does fit all. Prise is the go-to solution for modular benching, allowing you to build and arrange to fit your workspace. Keep cords, electronics and more all together with standard integrated power trays and slide-out tabletops.



Private Office



Conference



Side-by-Side



Three-Seat



Three-Seat With Screens



Three-Seat With Returns



Six-Seat With Screens



Six-Seat With Returns

EFFECTIVE NOVEMBER 4, 2024

1. Side-by-Side Typical

Category	Code	Quantity	Description	List Price	Ext. Price
Bench Top	3021 SS SP2 TZ2472 TL27 GP05 GC02	1	Set of Two Bench Tops: 24" x 72", Grade 1 Laminate, Left and Right Grommets	\$898	\$898
Bench Base	3022 SS SP2 TZ2472 PIW	1	2-Seat Base: Single-Sided, 8-Wire Wall Infeed (Pairs With 24" x 72" Bench Top)	\$2,761	\$2,761
Modesty Screen	3093 MT8 DT501 MPC27 DS1066	2	Modesty Screen: 10" x 66", Grade 1 Laminate	\$338	\$676
Wire Management	3152 WM05	2	Cable Caddy Basket Without Power	\$98	\$196
TOTAL:					\$4,531

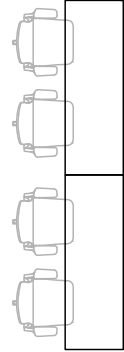

2. Private Office Typical

Category	Code	Quantity	Description	List Price	Ext. Price
Bench Top	3021 SS SP1 TZ3072 TL27 GP00	1	Bench Top: 30" x 72", Grade 1 Laminate, No Grommets	\$484	\$484
Tabletop	3000 TZ2448 TL27 GP00 TTMP1 STF00	1	Rectangular Tabletop: 24" x 48", Grade 1 Laminate, Mending Plate Kit, No Stiffener, No Grommets	\$335	\$335
Tabletop	3000 TZ2472 TL27 GP00 TTMP1 STF00	1	Rectangular Tabletop: 24" x 72", Grade 1 Laminate, Mending Plate Kit, No Stiffener, No Grommets	\$463	\$463
Bench Base	3022 SS SP1 TZ3072 NPOW	1	1-Seat Base: Single-Sided, No Power (Pairs With 30" x 72" Bench Top)	\$1,029	\$1,029
Bench Base	3022 SS SP1 TZ2472 NPOW	1	1-Seat Base: Single-Sided, No Power (Pairs With 24" x 72" Tabletop)	\$1,029	\$1,029
Modesty Screen	3093 MT8 DT501 MPC27 DS1066	1	Modesty Screen: 10" x 66", Grade 1 Laminate	\$338	\$338
Storage	3150 CPT01 PDC02	1	Mobile Pedestal With Upholstered Cushion, Grade 1 Textile	\$508	\$508
TOTAL:					\$4,186

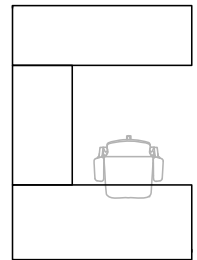

See [page 623](#) to order tabletops.

EFFECTIVE NOVEMBER 4, 2024

3. Conference Typical

Category	Code	Quantity	Description	List Price	Ext. Price
Tabletop	3000 TZ4896 TL27 GP00 TTMP0 STF00	1	Rectangular Tabletop: 48" x 96", Grade 1 Laminate, No Grommets, No Stiffener	\$1,152	\$1,152
Bench Base	3022 BB SP2 TZ3066 NPOW	1	2-Seat Base: Back-to-Back, No Power	\$1,617	\$1,617

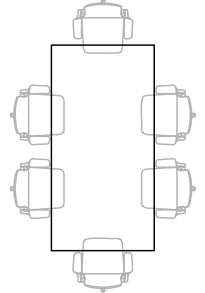

See [page 623](#) to order oversized tabletops.

TOTAL: \$2,769

4. Three Seat Typical

Category	Code	Quantity	Description	List Price	Ext. Price
Bench Top	3021 SS SP3 TZ3060 TL27 GP05 GC02	1	Set of Three Bench Tops: 30" x 60", Grade 1 Laminate, Left and Right Grommets	\$1,392	\$1,392
Bench Base	3022 SS SP3 TZ3060 PIW	1	3-Seat Base: Single-Sided, 8-Wire Wall Infeed (Pairs With 30" x 60" Bench Top)	\$4,018	\$4,018
Modesty Screen	3093 MT8 DT501 MPC27 DS1054	3	Modesty Screen: 10" x 54", Grade 1 Laminate	\$289	\$867
Storage	3150 CPT01 PDC02	3	Mobile Pedestal With Upholstered Cushion, Grade 1 Textile	\$508	\$1,524
Wire Management	3152 WM05	3	Cable Caddy Basket Without Power	\$98	\$294

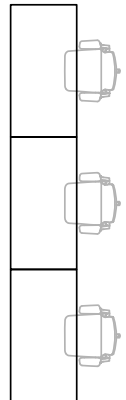

TOTAL: \$8,095

5. Three Seat Typical With Screens

Category	Code	Quantity	Description	List Price	Ext. Price
Bench Top	3021 SS SP3 TZ3060 TL27 GP05 GC02	1	Set of Three Bench Tops: 30" x 60", Grade 1 Laminate, Left and Right Grommets	\$1,392	\$1,392
Bench Base	3022 SS SP3 TZ3060 PIW	1	3-Seat Base: Single Sided, 8-Wire Wall Infeed (Pairs With 30" x 60" Bench Top)	\$4,018	\$4,018
Screen	3090 MT5 DT701 DS3060	3	30" x 60" Screen, Fabric, Grade 1 Textile, Midway Mounts	\$793	\$2,379
Storage	3150 CPT01 PDC02	3	Mobile Pedestal With Upholstered Cushion, Grade 1 Textile	\$508	\$1,524
Wire Management	3152 WM05	3	Cable Caddy Basket Without Power	\$98	\$294

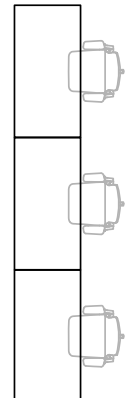

See the screens section starting [page 560](#) for midway mounts and other screen options

TOTAL: \$9,607

EFFECTIVE NOVEMBER 4, 2024

6. Three-Seat Typical With Returns

Category	Code	Quantity	Description	List Price	Ext. Price
Bench Top	3021 SS SP3 TZ3072 TL27 GP05 GC02	1	Set of Three Bench Tops: 30" x 72", Grade 1 Laminate, Left and Right Grommets	\$1,632	\$1,632
Return Top	3024 SS SP3 RP3 TN2448 TL27 GPR00	1	Set of Three Returntops: 24" x 48", Grade 1 Laminate, No Grommets	\$783	\$783
Bench Base	3022 SS SP3 TZ3072 PIW	1	3-Seat Base: Single-Sided, 8-Wire Wall Infeed (Pairs With 30" x 72" Bench Tops)	\$4,018	\$4,018
Return Base	3025 SS SP3 RP3 TN2448	1	Set of Three Return Bases: Single-Sided (Pairs With 24" x 48" Returntops)	\$1,680	\$1,680
Modesty Screen	3093 MT8 DT501 MPC27 DS1066	3	Modesty Screen: 10" x 66", Laminate	\$338	\$1,014
Storage	3150 CPT01 PDC02	3	Mobile Pedestal With Upholstered Cushion, Grade 1 Textile	\$508	\$1,524
Wire Management	3152 WM05	3	Cable Caddy Basket Without Power	\$98	\$294

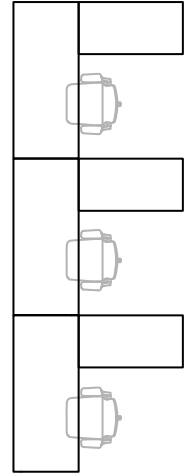

TOTAL: \$10,945

7. Six-Seat Typical With Screens

Category	Code	Quantity	Description	List Price	Ext. Price
Bench Top	3021 BB SP6 TZ3060 TL27 GP05 GC02	1	Set of Six Bench Tops: 30" x 60", Grade 1 Laminate, Left and Right Grommets	\$2,784	\$2,784
Bench Base	3022 BB SP6 TZ3060 PIW	1	6-Seat Base: Back-to-Back, 8-Wire Wall Infeed (Pairs With 30" x 60" Bench Tops)	\$6,068	\$6,068
Screen	3023 BB SP6 TZ3060 DT701 DS1860	1	Set of Three Screens: 18" x 60", Prise Mounts, Fabric, Grade 1 Textile	\$1,506	\$1,506
Storage	3150 CPT01 PDC02	6	Mobile Pedestal With Upholstered Cushion, Grade 1 Textile	\$508	\$3,048

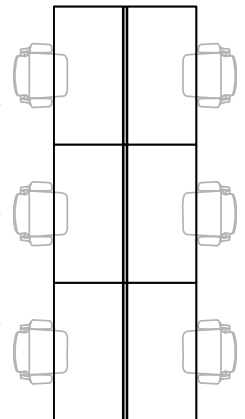

TOTAL: \$13,406

EFFECTIVE NOVEMBER 4, 2024

8. Six-Seat Typical With Returns

Category	Code	Quantity	Description	List Price	Ext. Price	
Bench Top	3021 BB SP6 TZ3072 TL27 GP05 GC02	1	Set of Six Bench Tops: 30" x 72", Grade 1 Laminate, Left and Right Grommets	\$3,264	\$3,264	
Return Top	3024 BB SP6 RP6 TN2448 TL27 GPR00	1	Set of Six Returntops: 24" x 48", Grade 1 Laminate, No Grommets	\$1,566	\$1,566	
Bench Base	3022 BB SP6 TZ3072 PIW	1	6-Seat Base: Back-to-Back, 8-Wire Wall Infeed (Pairs With 30" x 72" Bench Tops)	\$6,068	\$6,068	
Return Base	3025 BB SP6 RP6 TN2448	1	Set of Six Return Bases (Pairs With 24" x 48" Returntops)	\$3,360	\$3,360	
Screen	3023 BB SP6 TZ3072 DT701 DS1872	1	Set of Three Screens: 18" x 72", Prise Mounts, Fabric, Grade 1 Textile	\$1,695	\$1,695	
Storage	3150 CPT01 PDC02	6	Mobile Pedestal With Upholstered Cushion, Grade 1 Textile	\$508	\$3,048	

TOTAL: \$19,001

Prise

BENCHING

One size really does fit all. Prise is the go-to solution for modular benching, allowing you to build and arrange to fit your workspace. Keep cords, electronics and more all together with standard integrated power trays and slide-out tabletops.



6-Seat

Chairs not included; see [page 132](#) for Novo.
Storage not included; see [page 614](#) for mobile pedestals.

EFFECTIVE NOVEMBER 4, 2024

Featured Models

2-SEAT :: \$4,531

2-seat, single-sided,
24" x 72" bench tops, 10" x 66"
laminated modesty screens, and wire
basket wire management

6-SEAT :: \$13,406

6-seat, back-to-back, 30" x 60" bench
tops with grommets on the left and
right, 18" x 60" fabric screens, mobile
pedestals with upholstered pads

6-SEAT+RETURNS :: \$19,001

6-seat, back-to-back, 30" x 72"
bench tops with grommets on the left
and right, 18" x 72" fabric screens,
24" x 48" returns, mobile pedestals
with upholstered pads

Features

- Steel-frame-constructed bench with standard white base
- Mount screens easily with centered built-in extrusion on bench
- Manage wires with standard integrated power trays and slide-out function for tabletops
- Choose from 11 standard laminate tabletop finishes
- Pick grommets from two colors and specify in multiple locations
- Fixed glides are standard on all models
- Four power ports come standard per bench station; data add-on optional when specified with power
- Provide added convenience with a variety of additional wire management and power options



SPECIFICATIONS

	3021 SS Single-Sided Benching	3021 BB Back-to-Back Benching
Total Depth of Benches	24" 30"	51.44" (24" Top) 63.44" (30" Top)
Space Between Back-to-Back Benches	N/A	3.44"
Gap on Either Side of Center Rail	N/A	1.09"
Bench Top Thickness	1.125"	1.125"
Side-to-Side Gap (Mid Run)	0.125"	0.125"
Height With Bench Top	29.3"	29.3"
Height From Floor to Underside of Base	24.24"	24.24"
Distance Between Legs (Depth) at Base (Inside-Edge-to-Inside-Edge End)	17.52"	40.42"
Distance Between Legs (Depth) at Top	9"	32"
Distance Between Legs at Base (Outside-Edge-to-Outside-Edge)	23.96"	46.85"
Leg Depth	3.17"	3.17"
Leg Width	1.99"	1.99"
Weight Capacity (Per Seat or Return)	200 lb	200 lb

BENCH TOP

TOPS AND BASES ARE SPECIFIED AND SOLD SEPARATELY.

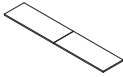
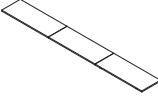
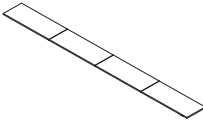
1. Product

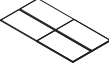
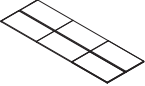
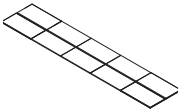
Product Type	Code	Price	
Bench Top	3021	Priced by Size	
Orientation	Code	Price	
Single-Sided	SS	Priced by Size	
Back-to-Back	BB	Priced by Size	
Seated Positions	Code	Price	
Single-Sided			
One Seat	SP1	Priced by Size	
Two Seats	SP2	Priced by Size	
Three Seats	SP3	Priced by Size	
Four Seats	SP4	Priced by Size	
Back-to-Back			
Two Seats	SP2	Priced by Size	
Four Seats	SP4	Priced by Size	
Six Seats	SP6	Priced by Size	
Eight Seats	SP8	Priced by Size	
Matching Base Style	Code	Price	
2-Stage T-Leg	TBT5	Priced by Size	

2. Finish

Laminate	Code	Price
Grade 1 Laminate		
Ankara Cherry	TL18	Priced by Size
Black	TL19	Priced by Size
Brazilian Walnut	TL20	Priced by Size
Cabinet Maple	TL21	Priced by Size
Driftwood	TL23	Priced by Size
Folkstone Grey	TL24	Priced by Size
Libretti	TL25	Priced by Size
Queenston Oak	TL26	Priced by Size
Sandalwood	TL27	Priced by Size
Walnut Amati	TL28	Priced by Size
White	TL29	Priced by Size
Grade 2 Laminate		
Classic Linen	TL17	Priced by Size
Colombian Walnut	TL55	Priced by Size
Crisp Linen	TL64	Priced by Size
Designer White	TL66	Priced by Size
Field Elm	TL13	Priced by Size
Frosty White	TL16	Priced by Size
Grey	TL62	Priced by Size
Grey Elm	TL51	Priced by Size
Kingswood Walnut	TL53	Priced by Size
Manitoba	TL56	Priced by Size
Neo Walnut	TL50	Priced by Size
Platinum	TL61	Priced by Size
Portico Teak	TL60	Priced by Size
Skyline Walnut	TL15	Priced by Size
Steel Mesh	TL59	Priced by Size
Tuscan Walnut	TL57	Priced by Size
Uptown Walnut	TL14	Priced by Size
Laminate Grade	Code	Price
Laminate Grade 1	GR1	Priced by Size
Laminate Grade 2	GR2	Priced by Size

BENCH TOP

TOPS AND BASES ARE SPECIFIED AND SOLD SEPARATELY.

3. Shape

Bench Top Shape	Code	Price
Rectangular Bench Top	TZ	Priced by Size

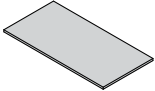

4. Size

Depth x Width	Code	Laminate Price	
One Seat (SS)		Grade 1	Grade 2
24" x 48"	2448	\$261	\$392
24" x 54"	2454	\$292	\$438
24" x 60"	2460	\$324	\$486
24" x 66"	2466	\$358	\$537
24" x 72"	2472	\$389	\$584
30" x 48"	3048	\$324	\$486
30" x 54"	3054	\$366	\$549
30" x 60"	3060	\$404	\$606
30" x 66"	3066	\$445	\$668
30" x 72"	3072	\$484	\$726
Two Seats (SS or BB)		Grade 1	Grade 2
24" x 48"	2448	\$522	\$784
24" x 54"	2454	\$584	\$876
24" x 60"	2460	\$648	\$972
24" x 66"	2466	\$716	\$1,074
24" x 72"	2472	\$778	\$1,168
30" x 48"	3048	\$648	\$972
30" x 54"	3054	\$732	\$1,098
30" x 60"	3060	\$808	\$1,212
30" x 66"	3066	\$890	\$1,336
30" x 72"	3072	\$968	\$1,452
Three Seats (SS)		Grade 1	Grade 2
24" x 48"	2448	\$783	\$1,176
24" x 54"	2454	\$876	\$1,314
24" x 60"	2460	\$972	\$1,458
24" x 66"	2466	\$1,074	\$1,611
24" x 72"	2472	\$1,167	\$1,752
30" x 48"	3048	\$972	\$1,458
30" x 54"	3054	\$1,098	\$1,647
30" x 60"	3060	\$1,212	\$1,818
30" x 66"	3066	\$1,335	\$2,004
30" x 72"	3072	\$1,452	\$2,178

4. Size (Cont.)

Depth x Width	Code	Laminate Price	
		Grade 1	Grade 2
Four Seats (SS or BB)			
24" x 48"	2448	\$1,044	\$1,568
24" x 54"	2454	\$1,168	\$1,752
24" x 60"	2460	\$1,296	\$1,944
24" x 66"	2466	\$1,432	\$2,148
24" x 72"	2472	\$1,556	\$2,336
30" x 48"	3048	\$1,296	\$1,944
30" x 54"	3054	\$1,464	\$2,196
30" x 60"	3060	\$1,616	\$2,424
30" x 66"	3066	\$1,780	\$2,672
30" x 72"	3072	\$1,936	\$2,904
Six Seats (BB)			
24" x 48"	2448	\$1,566	\$2,352
24" x 54"	2454	\$1,752	\$2,628
24" x 60"	2460	\$1,944	\$2,916
24" x 66"	2466	\$2,148	\$3,222
24" x 72"	2472	\$2,334	\$3,504
30" x 48"	3048	\$1,944	\$2,916
30" x 54"	3054	\$2,196	\$3,294
30" x 60"	3060	\$2,424	\$3,636
30" x 66"	3066	\$2,670	\$4,008
30" x 72"	3072	\$2,904	\$4,356
Eight Seats (BB)			
24" x 48"	2448	\$2,088	\$3,136
24" x 54"	2454	\$2,336	\$3,504
24" x 60"	2460	\$2,592	\$3,888
24" x 66"	2466	\$2,864	\$4,296
24" x 72"	2472	\$3,112	\$4,672
30" x 48"	3048	\$2,592	\$3,888
30" x 54"	3054	\$2,928	\$4,392
30" x 60"	3060	\$3,232	\$4,848
30" x 66"	3066	\$3,560	\$5,344
30" x 72"	3072	\$3,872	\$5,808

BENCH TOP





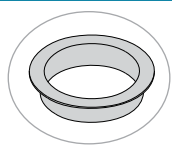



TOPS AND BASES ARE SPECIFIED AND SOLD SEPARATELY.

5. Grommets

Grommet Location	Code	Price	
None	GP00	+ \$0	
One Seat (SS)			
Left	GP01	+ \$30	
Right	GP03	+ \$30	
Left and Right	GP05	+ \$60	
Two Seats (SS or BB)			
Left	GP01	+ \$60	
Right	GP03	+ \$60	
Left and Right	GP05	+ \$120	
Three Seats (SS)			
Left	GP01	+ \$90	
Right	GP03	+ \$90	
Left and Right	GP05	+ \$180	
Four Seats (SS or BB)			
Left	GP01	+ \$120	
Right	GP03	+ \$120	
Left and Right	GP05	+ \$240	
Six Seats (BB)			
Left	GP01	+ \$180	
Right	GP03	+ \$180	
Left and Right	GP05	+ \$360	
Eight Seats (BB)			
Left	GP01	+ \$240	
Right	GP03	+ \$240	
Left and Right	GP05	+ \$480	
Grommet Color	Code	Price	
Black	GC01	+ \$0	
White	GC02	+ \$0	

EFFECTIVE NOVEMBER 4, 2024

1. Product

Product Type	Code	Price	
Bench Bases	3022	Priced by Seated Positions	
Product Style	Code	Price	
2-Stage T-Leg	TBT5	Priced by Seated Positions	
Orientation	Code	Price	
Single-Sided	SS	Priced by Seated Positions	
Back-to-Back	BB	Priced by Seated Positions	
Seated Postions	Code	Price	
Single-Sided			
1-Seat	SP1	\$1,029	
2-Seat	SP2	\$1,830	
3-Seat	SP3	\$2,631	
4-Seat	SP4	\$3,431	
Back-to-Back			
2-Seat	SP2	\$1,617	
4-Seat	SP4	\$2,773	
6-Seat	SP6	\$3,930	
8-Seat	SP8	\$5,086	

BENCH BASE

TOPS AND BASES ARE SPECIFIED AND SOLD SEPARATELY.

2. Matching Tabletop

Tabletop Shape	Code	Price	
Rectangular	TZ	+ \$0	
Tabletop Size			
No Top	0	+ \$0	
24" x 48"	2448	+ \$0	
24" x 54"	2454	+ \$0	
24" x 60"	2460	+ \$0	
24" x 66"	2466	+ \$0	
24" x 72"	2472	+ \$0	
30" x 48"	3048	+ \$0	
30" x 54"	3054	+ \$0	
30" x 60"	3060	+ \$0	
30" x 66"	3066	+ \$0	
30" x 72"	3072	+ \$0	

Bench bases require the specification of a bench top size. Bases take their size from their corresponding top size.

3. Power

Power Type	Code	Price	
No Power Pack	NPOW	+ \$0	
Single-Sided, 8-Wire Wall Infeed			
One Seat	PIW	+ \$477	
Two Seats	PIW	+ \$931	
Three Seats	PIW	+ \$1,387	
Four Seats	PIW	+ \$1,844	
Single-Sided, 8-Wire Ceiling Infeed			
One Seat	PIC	+ \$506	
Two Seats	PIC	+ \$962	
Three Seats	PIC	+ \$1,421	
Four Seats	PIC	+ \$1,876	
Back-to-Back, 8-Wire Wall Infeed			
Two Seats	PIW	+ \$725	
Four Seats	PIW	+ \$1,431	
Six Seats	PIW	+ \$2,138	
Eight Seats	PIW	+ \$2,845	
Back-to-Back, 8-Wire Ceiling Infeed			
Two Seats	PIC	+ \$759	
Four Seats	PIC	+ \$1,464	
Six Seats	PIC	+ \$2,170	
Eight Seats	PIC	+ \$2,878	

Infeeds come standard with one dual outlet power module per seat.

EFFECTIVE NOVEMBER 4, 2024

1. Return Top

Product Type	Code	Price
Return Top	3024	Priced by Size
Orientation	Code	Price
Single-Sided	SS	Priced by Size
Back-to-Back	BB	Priced by Size
Seated Postions	Code	Price
Single-Sided		
One Seat	SP1	Priced by Size
Two Seats	SP2	Priced by Size
Three Seats	SP3	Priced by Size
Four Seats	SP4	Priced by Size
Back-to-Back		
Two Seats	SP2	Priced by Size
Four Seats	SP4	Priced by Size
Six Seats	SP6	Priced by Size
Eight Seats	SP8	Priced by Size
Return Quantity	Code	Price
One	RP1	Priced by Size
Two	RP2	Priced by Size
Three	RP3	Priced by Size
Four	RP4	Priced by Size
Five	RP5	Priced by Size
Six	RP6	Priced by Size
Seven	RP7	Priced by Size
Eight	RP8	Priced by Size

RETURN TOP

TOPS AND BASES ARE SPECIFIED AND SOLD SEPARATELY.

2. Finish

Laminate	Code	Price
Grade 1 Laminate		
Ankara Cherry	TL18	Priced by Size
Black	TL19	Priced by Size
Brazilian Walnut	TL20	Priced by Size
Cabinet Maple	TL21	Priced by Size
Driftwood	TL23	Priced by Size
Folkstone Grey	TL24	Priced by Size
Libretti	TL25	Priced by Size
Queenston Oak	TL26	Priced by Size
Sandalwood	TL27	Priced by Size
Walnut Amati	TL28	Priced by Size
White	TL29	Priced by Size
Grade 2 Laminate		
Classic Linen	TL17	Priced by Size
Colombian Walnut	TL55	Priced by Size
Crisp Linen	TL64	Priced by Size
Designer White	TL66	Priced by Size
Field Elm	TL13	Priced by Size
Frosty White	TL16	Priced by Size
Grey	TL62	Priced by Size
Grey Elm	TL51	Priced by Size
Kingswood Walnut	TL53	Priced by Size
Manitoba	TL56	Priced by Size
Neo Walnut	TL50	Priced by Size
Platinum	TL61	Priced by Size
Portico Teak	TL60	Priced by Size
Skyline Walnut	TL15	Priced by Size
Steel Mesh	TL59	Priced by Size
Tuscan Walnut	TL57	Priced by Size
Uptown Walnut	TL14	Priced by Size
Laminate Grade	Code	Price
Laminate Grade 1	GR1	Priced by Size
Laminate Grade 2	GR2	Priced by Size

3. Shape

Bench Top Shape	Code	Price
Rectangular Return Top	TN	Priced by Size

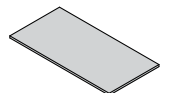

4. Size

Returntop Size (D x W)	Code	Price	
One		Grade 1	Grade 2
24" x 36"	2436	\$196	\$294
24" x 42"	2442	\$229	\$344
24" x 48"	2448	\$261	\$392
30" x 30"	3030	\$205	\$308
30" x 36"	3036	\$244	\$366
30" x 42"	3042	\$285	\$428
Two		Grade 1	Grade 2
24" x 36"	2436	\$392	\$588
24" x 42"	2442	\$458	\$688
24" x 48"	2448	\$522	\$784
30" x 30"	3030	\$410	\$616
30" x 36"	3036	\$488	\$732
30" x 42"	3042	\$570	\$856
Three		Grade 1	Grade 2
24" x 36"	2436	\$588	\$882
24" x 42"	2442	\$687	\$1,032
24" x 48"	2448	\$783	\$1,176
30" x 30"	3030	\$615	\$924
30" x 36"	3036	\$732	\$1,098
30" x 42"	3042	\$855	\$1,284
Four		Grade 1	Grade 2
24" x 36"	2436	\$784	\$1,176
24" x 42"	2442	\$916	\$1,376
24" x 48"	2448	\$1,044	\$1,568
30" x 30"	3030	\$820	\$1,232
30" x 36"	3036	\$976	\$1,464
30" x 42"	3042	\$1,140	\$1,712
Five		Grade 1	Grade 2
24" x 36"	2436	\$980	\$1,470
24" x 42"	2442	\$1,145	\$1,720
24" x 48"	2448	\$1,305	\$1,960
30" x 30"	3030	\$1,025	\$1,540
30" x 36"	3036	\$1,220	\$1,830
30" x 42"	3042	\$1,425	\$2,140
Six		Grade 1	Grade 2
24" x 36"	2436	\$1,176	\$1,764
24" x 42"	2442	\$1,374	\$2,064
24" x 48"	2448	\$1,566	\$2,352
30" x 30"	3030	\$1,230	\$1,848
30" x 36"	3036	\$1,464	\$2,196
30" x 42"	3042	\$1,710	\$2,568

RETURN TOP

TOPS AND BASES ARE SPECIFIED AND SOLD SEPARATELY.

4. Size (Cont.)

Returntop Size (D x W)	Code	Price	
Seven		Grade 1	Grade 2
24" x 36"	2436	\$1,372	\$2,058
24" x 42"	2442	\$1,603	\$2,408
24" x 48"	2448	\$1,827	\$2,744
30" x 30"	3030	\$1,435	\$2,156
30" x 36"	3036	\$1,708	\$2,562
30" x 42"	3042	\$1,995	\$2,996
Eight		Grade 1	Grade 2
24" x 36"	2436	\$1,568	\$2,352
24" x 42"	2442	\$1,832	\$2,752
24" x 48"	2448	\$2,088	\$3,136
30" x 30"	3030	\$1,640	\$2,464
30" x 36"	3036	\$1,952	\$2,928
30" x 42"	3042	\$2,280	\$3,424

EFFECTIVE NOVEMBER 4, 2024

5. Grommets

Grommet Location	Code	Price	
None	GPR00	+ \$0	
One Seat			
Left	GPR01	+ \$30	
Right	GPR03	+ \$30	
Left and Right	GPR05	+ \$60	
Two Seats			
Left	GPR01	+ \$60	
Right	GPR03	+ \$60	
Left and Right	GPR05	+ \$120	
Three Seats			
Left	GPR01	+ \$90	
Right	GPR03	+ \$90	
Left and Right	GPR05	+ \$180	
Four Seats			
Left	GPR01	+ \$120	
Right	GPR03	+ \$120	
Left and Right	GPR05	+ \$240	
Five Seats			
Left	GPR01	+ \$150	
Right	GPR03	+ \$150	
Left and Right	GPR05	+ \$300	
Six Seats			
Left	GPR01	+ \$180	
Right	GPR03	+ \$180	
Left and Right	GPR05	+ \$360	
Seven Seats			
Left	GPR01	+ \$210	
Right	GPR03	+ \$210	
Left and Right	GPR05	+ \$420	
Eight Seats			
Left	GPR01	+ \$240	
Right	GPR03	+ \$240	
Left and Right	GPR05	+ \$480	
Grommet Color	Code	Price	
Black	GC01	+ \$0	
White	GC02	+ \$0	

EFFECTIVE NOVEMBER 4, 2024

1. Product

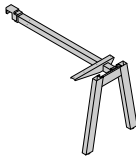
Product Type	Code	Price	
Return Base	3025	Priced by Quantity	

Orientation	Code	Price	
Single-Sided	SS	Priced by Quantity	
Back-to-Back	BB	Priced by Quantity	

Seated Postions	Code	Price	
Single-Sided			
One Seat	SP1	Priced by Quantity	
Two Seats	SP2	Priced by Quantity	
Three Seats	SP3	Priced by Quantity	
Four Seats	SP4	Priced by Quantity	
Back-to-Back			
Two Seats	SP2	Priced by Quantity	
Four Seats	SP4	Priced by Quantity	
Six Seats	SP6	Priced by Quantity	
Eight Seats	SP8	Priced By Quantity	

Return Quantity	Code	Price	
One	RP1	\$560	
Two	RP2	\$1,120	
Three	RP3	\$1,680	
Four	RP4	\$2,240	
Five	RP5	\$2,800	
Six	RP6	\$3,360	
Seven	RP7	\$3,920	
Eight	RP8	\$4,480	

Number of returns cannot exceed the number of seats.

RETURN BASE

TOPS AND BASES ARE SPECIFIED AND SOLD SEPARATELY.

2. Size

Returntop Size (D x W)	Code	Price	
No Return	TN0	+ \$0	
24" x 36"	TN2436	+ \$0	
24" x 42"	TN2442	+ \$0	
24" x 48"	TN2448	+ \$0	
30" x 30"	TN3030	+ \$0	
30" x 36"	TN3036	+ \$0	
30" x 42"	TN3042	+ \$0	

Return bases require the specification of a returntop size. Bases take their size from their corresponding top size.

1. Product

Product Type	Code	Price
Screen	3023	Priced By Screen Size

2. Matching Benching

Orientation	Code	Price
Single-Sided	SS	Priced By Screen Size
Back-to-Back	BB	Priced By Screen Size

Seated Positions	Code	Price
Single-Sided		

One Seat	SP1	Priced By Screen Size
----------	-----	-----------------------

Two Seats	SP2	Priced By Screen Size
-----------	-----	-----------------------

Three Seats	SP3	Priced By Screen Size
-------------	-----	-----------------------

Four Seats	SP4	Priced By Screen Size
------------	-----	-----------------------

Back-to-Back		
--------------	--	--

Two Seats	SP2	Priced by Screen Size
-----------	-----	-----------------------

Four Seats	SP4	Priced by Screen Size
------------	-----	-----------------------

Six Seats	SP6	Priced by Screen Size
-----------	-----	-----------------------

Eight Seats	SP8	Priced by Screen Size
-------------	-----	-----------------------

Bench Top Size	Code	Price
----------------	------	-------

None	TZ0	Priced by Screen Size
------	-----	-----------------------

24" x 48"	TZ2448	Priced by Screen Size
-----------	--------	-----------------------

24" x 54"	TZ2454	Priced by Screen Size
-----------	--------	-----------------------

24" x 60"	TZ2460	Priced by Screen Size
-----------	--------	-----------------------

24" x 66"	TZ2466	Priced by Screen Size
-----------	--------	-----------------------

24" x 72"	TZ2472	Priced by Screen Size
-----------	--------	-----------------------

30" x 48"	TZ3048	Priced by Screen Size
-----------	--------	-----------------------

30" x 54"	TZ3054	Priced by Screen Size
-----------	--------	-----------------------

30" x 60"	TZ3060	Priced by Screen Size
-----------	--------	-----------------------

30" x 66"	TZ3066	Priced by Screen Size
-----------	--------	-----------------------

30" x 72"	TZ3072	Priced by Screen Size
-----------	--------	-----------------------

Single-sided orientation comes standard with edge mounts. Back-to-back orientation includes the cost of Prize-specific screen mounts.

Screens require the specification of a bench top size. Screen length may not exceed bench top length.

3. Material

Screen Material	Code	Price
Frosted Acrylic	DT101	Priced by Screen Size
Fabric	DT701	Priced by Screen Size
Markerboard	DT301	Priced by Screen Size

SCREENS

4. Size

Screen Size (H x L)	Code	Price		
One Seat, Single-Sided		Acrylic	Fabric	Markerboard
12" x 48"	DS1248	\$346	\$408	\$301
12" x 54"	DS1254	\$380	\$428	\$327
12" x 60"	DS1260	\$455	\$491	\$396
12" x 66"	DS1266	\$487	\$513	\$422
12" x 72"	DS1272	\$519	\$537	\$448
18" x 48"	DS1848	\$475	\$534	\$404
18" x 54"	DS1854	\$522	\$564	\$444
18" x 60"	DS1860	\$615	\$634	\$525
18" x 66"	DS1866	\$617	\$666	\$565
18" x 72"	DS1872	\$659	\$697	\$607
24" x 48"	DS2448	\$544	\$571	\$509
24" x 54"	DS2454	\$616	\$623	\$563
24" x 60"	DS2460	\$701	\$725	\$657
24" x 66"	DS2466	\$757	\$789	\$709
24" x 72"	DS2472	\$815	\$863	\$761
Two Seat, Single-Sided		Acrylic	Fabric	Markerboard
12" x 48"	DS1248	\$692	\$816	\$602
12" x 54"	DS1254	\$760	\$856	\$654
12" x 60"	DS1260	\$910	\$982	\$792
12" x 66"	DS1266	\$974	\$1,026	\$844
12" x 72"	DS1272	\$1,038	\$1,074	\$896
18" x 48"	DS1848	\$950	\$1,068	\$808
18" x 54"	DS1854	\$1,044	\$1,128	\$888
18" x 60"	DS1860	\$1,230	\$1,268	\$1,050
18" x 66"	DS1866	\$1,234	\$1,332	\$1,130
18" x 72"	DS1872	\$1,318	\$1,394	\$1,214
24" x 48"	DS2448	\$1,088	\$1,142	\$1,018
24" x 54"	DS2454	\$1,232	\$1,246	\$1,126
24" x 60"	DS2460	\$1,402	\$1,450	\$1,314
24" x 66"	DS2466	\$1,514	\$1,578	\$1,418
24" x 72"	DS2472	\$1,630	\$1,726	\$1,522

4. Size (Cont.)

Screen Size (H x L)	Code	Price		
Three Seats, Single-Sided		Acrylic	Fabric	Markerboard
12" x 48"	DS1248	\$1,038	\$1,224	\$903
12" x 54"	DS1254	\$1,140	\$1,284	\$981
12" x 60"	DS1260	\$1,365	\$1,473	\$1,188
12" x 66"	DS1266	\$1,461	\$1,539	\$1,266
12" x 72"	DS1272	\$1,557	\$1,611	\$1,344
18" x 48"	DS1848	\$1,425	\$1,602	\$1,212
18" x 54"	DS1854	\$1,566	\$1,692	\$1,332
18" x 60"	DS1860	\$1,845	\$1,902	\$1,575
18" x 66"	DS1866	\$1,851	\$1,998	\$1,695
18" x 72"	DS1872	\$1,977	\$2,091	\$1,821
24" x 48"	DS2448	\$1,632	\$1,713	\$1,527
24" x 54"	DS2454	\$1,848	\$1,869	\$1,689
24" x 60"	DS2460	\$2,103	\$2,175	\$1,971
24" x 66"	DS2466	\$2,271	\$2,367	\$2,127
24" x 72"	DS2472	\$2,445	\$2,589	\$2,283
Four Seats, Single-Sided		Acrylic	Fabric	Markerboard
12" x 48"	DS1248	\$1,384	\$1,632	\$1,204
12" x 54"	DS1254	\$1,520	\$1,712	\$1,308
12" x 60"	DS1260	\$1,820	\$1,964	\$1,584
12" x 66"	DS1266	\$1,948	\$2,052	\$1,688
12" x 72"	DS1272	\$2,076	\$2,148	\$1,792
18" x 48"	DS1848	\$1,900	\$2,136	\$1,616
18" x 54"	DS1854	\$2,088	\$2,256	\$1,776
18" x 60"	DS1860	\$2,460	\$2,536	\$2,100
18" x 66"	DS1866	\$2,468	\$2,664	\$2,260
18" x 72"	DS1872	\$2,636	\$2,788	\$2,428
24" x 48"	DS2448	\$2,176	\$2,284	\$2,036
24" x 54"	DS2454	\$2,464	\$2,492	\$2,252
24" x 60"	DS2460	\$2,804	\$2,900	\$2,628
24" x 66"	DS2466	\$3,028	\$3,156	\$2,836
24" x 72"	DS2472	\$3,260	\$3,452	\$3,044

4. Size (Cont.)

Screen Size (H x L)	Code	Price		
Two Seats, Back-to-Back		Acrylic	Fabric	Markerboard
12" x 48"	DS1248	\$258	\$320	\$213
12" x 54"	DS1254	\$292	\$340	\$239
12" x 60"	DS1260	\$323	\$359	\$264
12" x 66"	DS1266	\$355	\$381	\$290
12" x 72"	DS1272	\$387	\$405	\$316
18" x 48"	DS1848	\$387	\$446	\$316
18" x 54"	DS1854	\$434	\$476	\$356
18" x 60"	DS1860	\$483	\$502	\$393
18" x 66"	DS1866	\$485	\$534	\$433
18" x 72"	DS1872	\$527	\$565	\$475
24" x 48"	DS2448	\$456	\$483	\$421
24" x 54"	DS2454	\$528	\$535	\$475
24" x 60"	DS2460	\$569	\$593	\$525
24" x 66"	DS2466	\$625	\$657	\$577
24" x 72"	DS2472	\$683	\$731	\$629
Four Seats, Back-to-Back		Acrylic	Fabric	Markerboard
12" x 48"	DS1248	\$516	\$640	\$426
12" x 54"	DS1254	\$584	\$680	\$478
12" x 60"	DS1260	\$646	\$718	\$528
12" x 66"	DS1266	\$710	\$762	\$580
12" x 72"	DS1272	\$774	\$810	\$632
18" x 48"	DS1848	\$774	\$892	\$632
18" x 54"	DS1854	\$868	\$952	\$712
18" x 60"	DS1860	\$966	\$1,004	\$786
18" x 66"	DS1866	\$970	\$1,068	\$866
18" x 72"	DS1872	\$1,054	\$1,130	\$950
24" x 48"	DS2448	\$912	\$966	\$842
24" x 54"	DS2454	\$1,056	\$1,070	\$950
24" x 60"	DS2460	\$1,138	\$1,186	\$1,050
24" x 66"	DS2466	\$1,250	\$1,314	\$1,154
24" x 72"	DS2472	\$1,366	\$1,462	\$1,258

EFFECTIVE NOVEMBER 4, 2024

4. Size (Cont.)

Screen Size (H x L)	Code	Price		
Six Seats, Back-to-Back		Acrylic	Fabric	Markerboard
12" x 48"	DS1248	\$774	\$960	\$639
12" x 54"	DS1254	\$876	\$1,020	\$717
12" x 60"	DS1260	\$969	\$1,077	\$792
12" x 66"	DS1266	\$1,065	\$1,143	\$870
12" x 72"	DS1272	\$1,161	\$1,215	\$948
18" x 48"	DS1848	\$1,161	\$1,338	\$948
18" x 54"	DS1854	\$1,302	\$1,428	\$1,068
18" x 60"	DS1860	\$1,449	\$1,506	\$1,179
18" x 66"	DS1866	\$1,455	\$1,602	\$1,299
18" x 72"	DS1872	\$1,581	\$1,695	\$1,425
24" x 48"	DS2448	\$1,368	\$1,449	\$1,263
24" x 54"	DS2454	\$1,584	\$1,605	\$1,425
24" x 60"	DS2460	\$1,707	\$1,779	\$1,575
24" x 66"	DS2466	\$1,875	\$1,971	\$1,731
24" x 72"	DS2472	\$2,049	\$2,193	\$1,887
Eight Seats, Back-to-Back		Acrylic	Fabric	Markerboard
12" x 48"	DS1248	\$1,032	\$1,280	\$852
12" x 54"	DS1254	\$1,168	\$1,360	\$956
12" x 60"	DS1260	\$1,292	\$1,436	\$1,056
12" x 66"	DS1266	\$1,420	\$1,524	\$1,160
12" x 72"	DS1272	\$1,548	\$1,620	\$1,264
18" x 48"	DS1848	\$1,548	\$1,784	\$1,264
18" x 54"	DS1854	\$1,736	\$1,904	\$1,424
18" x 60"	DS1860	\$1,932	\$2,008	\$1,572
18" x 66"	DS1866	\$1,940	\$2,136	\$1,732
18" x 72"	DS1872	\$2,108	\$2,260	\$1,900
24" x 48"	DS2448	\$1,824	\$1,932	\$1,684
24" x 54"	DS2454	\$2,112	\$2,140	\$1,900
24" x 60"	DS2460	\$2,276	\$2,372	\$2,100
24" x 66"	DS2466	\$2,500	\$2,628	\$2,308
24" x 72"	DS2472	\$2,732	\$2,924	\$2,516

1. Power

Product Type	Code	Price
Data Pack	3029 PDP	+ \$55

Power Beam

SINGLE-SIDED | BACK-TO-BACK
INFEEED COVER | WIRE MANAGEMENT
POWER | DATA | DUPLEXES

eBEAM

POWER + DATA BEAM

Power innovation.

eBEAM is a straightforward, streamlined solution for adding power to your workstations. With adaptable legs, multiple beam lengths and cable management options that make it practically mess-free, eBEAM is simply powerful (and powerfully simple).

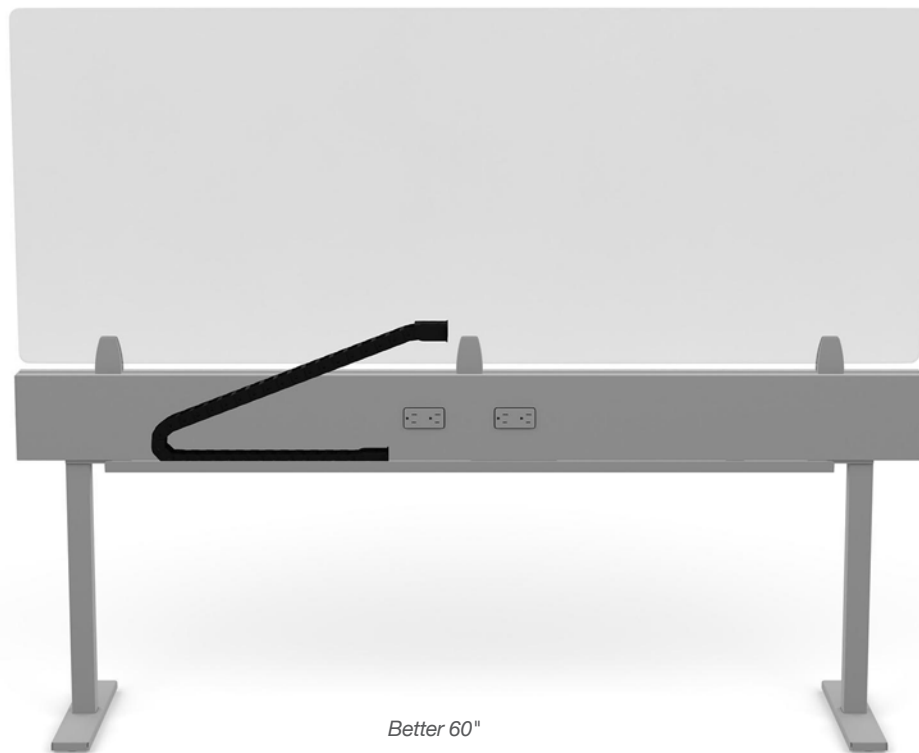

EFFECTIVE NOVEMBER 4, 2024

Featured Models

60" 2-SEAT WITH NO ACCESSORIES :: \$1,225

60" beam, back to back, 2-seat, 72" conduit infeed, four duplex receptacles, no accessories

60" 2-SEAT WITH ACCESSORIES :: \$2,298

60" beam, back to back, 2-seat, 72" conduit infeed, four duplex receptacles, horizontal wire trays, vertical wire manager, 24" x 60" frosted acrylic screen

60" 4-SEAT WITH ACCESSORIES :: \$4,343

60" beam, back to back, 4-seat, 72" conduit infeed, four duplex receptacles, horizontal wire tray, vertical wire manager, infeed cover, 24" x 60" grade 1 fabric screen

Features

- Quick and easy installation in less than 10 minutes
- Cable management accessories ensure an uncluttered look
- Responsive, adaptable design includes moveable leg positions
- Fits perfectly with any static or height-adjustable tabletop
- Seamless screen integration for providing privacy
- Beam sizes: 48," 60" and 72" (W) x 24 inches (H)
- Screen height options: 12", 18", 24" and 30"
- Screen material options: Clear acrylic, frosted acrylic, fabric and whiteboard
- 10 standard configurations.
Single-sided: 1-seat, 2-seat, 3-seat, 4-seat and 5-seat.
Back-to-back: 2-seat, 4-seat, 6-seat, 8-seat and 10-seat with adjustable leg positions
- 4-circuit, 8-wire power system included with standard or optional controlled duplex receptacles
- Power system is UL183 Listed
- Toolless power installation
- Optional horizontal, vertical and infeed wire management
- Data adapter kit included
- Data modules not included. See page 558 for a list of compatible modules.
- Tabletops that are 2" undersized are available and strongly recommended for use with eBEAM

1. Product

Product Type	Code	Price
Power Beam	3242	Priced by Seated Positions



Beam Length	Code	Price
48" W Power Beam	TW48	Priced by Seated Positions
60" W Power Beam	TW60	Priced by Seated Positions
72" W Power Beam	TW72	Priced by Seated Positions

POWER BEAM

1. Product (Cont.)

Orientation	Code	Price
Single-Sided	SS	Priced by Seated Positions
Back-to-Back	BB	Priced by Seated Positions

Seated Position	Code	Price
Single-Sided		
1-Seat, 48"	SP1	\$1,105
1-Seat, 60"	SP1	\$1,148
1-Seat, 72"	SP1	\$1,189
2-Seat, 48"	SP2	\$1,855
2-Seat, 60"	SP2	\$1,932
2-Seat, 72"	SP2	\$2,008
3-Seat, 48"	SP3	\$2,708
3-Seat, 60"	SP3	\$2,822
3-Seat, 72"	SP3	\$2,938
4-Seat, 48"	SP4	\$3,560
4-Seat, 60"	SP4	\$3,713
4-Seat, 72"	SP4	\$3,866
5-Seat, 48"	SP5	\$4,413
5-Seat, 60"	SP5	\$4,605
5-Seat, 72"	SP5	\$4,796
Back-to-Back		
2-Seat, 48"	SP2	\$1,182
2-Seat, 60"	SP2	\$1,225
2-Seat, 72"	SP2	\$1,266
4-Seat, 48"	SP4	\$2,009
4-Seat, 60"	SP4	\$2,086
4-Seat, 72"	SP4	\$2,162
6-Seat, 48"	SP6	\$2,939
6-Seat, 60"	SP6	\$3,053
6-Seat, 72"	SP6	\$3,169
8-Seat, 48"	SP8	\$3,869
8-Seat, 60"	SP8	\$4,022
8-Seat, 72"	SP8	\$4,175
10-Seat, 48"	SP10	\$4,798
10-Seat, 60"	SP10	\$4,990
10-Seat, 72"	SP10	\$5,183

Beams come standard with a standard 72" power infeed.

2. Finish

Paint Color	Code	Price
Silver	BF01	+ \$0
White	BF02	+ \$0
Black	BF03	+ \$0

3. Wire Management

Wire Management Type	Code	Price
No Wire Management	WM00	+ \$0

Horizontal Wire Tray

1-Seat	WM01	+ \$105
2-Seat	WM01	+ \$210
3-Seat	WM01	+ \$315
4-Seat	WM01	+ \$420
5-Seat	WM01	+ \$525
6-Seat	WM01	+ \$630
8-Seat	WM01	+ \$840
10-Seat	WM01	+ \$1,050

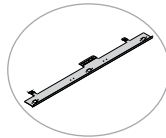

Horizontal Wire Tray And Vertical Wire Manager

1-Seat	WM06	+ \$210
2-Seat	WM06	+ \$420
3-Seat	WM06	+ \$630
4-Seat	WM06	+ \$840
5-Seat	WM06	+ \$1,050
6-Seat	WM06	+ \$1,260
8-Seat	WM06	+ \$1,680
10-Seat	WM06	+ \$2,100

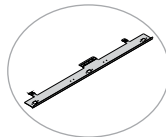

Infeed Cover	Code	Price
--------------	------	-------

No Power Infeed Cover	VLC0	\$0
-----------------------	------	-----

Power Infeed Cover	VLC1	+ \$63
--------------------	------	--------

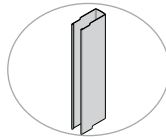

POWER BEAM

4. Electrical

Type and Length	Code	Price
-----------------	------	-------

Power Infeed

No Infeed	NPIF	- \$147
72" Conduit	PIC72	+ \$0
72" Liquidtight	PIL72	+ \$12
144" Conduit	PIC144	+ \$47
144" Liquidtight	PIL144	+ \$59

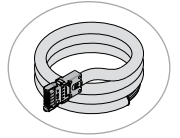

Type and Length	Code	Price
-----------------	------	-------

No Power, Single-Sided

1-Seat	NPOW	- \$283
2-Seat	NPOW	- \$507
3-Seat	NPOW	- \$730
4-Seat	NPOW	- \$954
5-Seat	NPOW	- \$1,177

No Power, Back-to-Back

2-Seat	NPOW	- \$283
4-Seat	NPOW	- \$507
6-Seat	NPOW	- \$730
8-Seat	NPOW	- \$954
10-Seat	NPOW	- \$1,177

Duplexes	Code	Price
----------	------	-------

Standard Duplex Receptacles, Two Per Seat	SDUP	+ \$0
---	------	-------

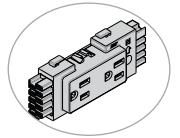

No Duplexes

1-Seat	NDUP	- \$79
2-Seat	NDUP	- \$158
3-Seat	NDUP	- \$237
4-Seat	NDUP	- \$316
5-Seat	NDUP	- \$395
6-Seat	NDUP	- \$474
8-Seat	NDUP	- \$632
10-Seat	NDUP	- \$790

Duplex receptacle color will match beam color. When power is specified in beam, it includes duplexes for circuits 1, 2, 3, and 4. For other combinations of duplexes and controlled duplexes, specify "no duplexes" and order as standalone components.

1. Product

Product Type	Code	Price
Screen for EBEAM	3243	Priced by Size
Beam	Code	Price
48"	TW48	Priced by Size
60"	TW60	Priced by Size
72"	TW72	Priced by Size
Beam Orientation	Code	Price
Single-Sided	SS	Priced by Size
Back-to-Back	BB	Priced by Size
Seated Positions	Code	Price
Single-Sided		
1-Seat	SP1	Priced by Size
2-Seat	SP2	Priced by Size
3-Seat	SP3	Priced by Size
4-Seat	SP4	Priced by Size
5-Seat	SP5	Priced by Size
Back-to-Back		
2-Seat	SP2	Priced by Size
4-Seat	SP4	Priced by Size
6-Seat	SP6	Priced by Size
8-Seat	SP8	Priced by Size
10-Seat	SP10	Priced by Size

2. Material

Material Type	Code	Price
Motif Fabric	DT701	Priced by Size
Sector Frosted Acrylic	DT101	Priced by Size
Sector Clear Acrylic	DT101C	Priced by Size
Doodle Markerboard	DT301	Priced by Size
Grade	Code	Price
Fabric/Vinyl Grade 1	FG1/VG1	Priced by Size
Fabric/Vinyl Grade 2	FG2/VG2	Priced by Size
Fabric/Vinyl Grade 3	FG3/VG3	Priced by Size
Fabric/Vinyl Grade 4	FG4/VG4	Priced by Size
Fabric/Vinyl Grade 5	FG5/VG5	Priced by Size

The following prices are for grade 1 fabrics/vinyls only. For higher grade pricing, add the appropriate upcharge from the Motif price list.

POWER BEAM SCREENS

3. Size

Screen Size (H x L)	Code	Grade 1 Price		
1-Seat, Single-Sided		Acrylic	Fabric	Markerboard
12" x 48"	DS1248	\$314	\$376	\$269
18" x 48"	DS1848	\$443	\$502	\$372
24" x 48"	DS2448	\$512	\$539	\$477
30" x 48"	DS3048	N/A	\$666	\$565
12" x 60"	DS1260	\$407	\$443	\$348
18" x 60"	DS1860	\$567	\$586	\$477
24" x 60"	DS2460	\$653	\$677	\$609
30" x 60"	DS3060	N/A	\$801	\$719
12" x 72"	DS1272	\$471	\$489	\$400
18" x 72"	DS1872	\$611	\$649	\$559
24" x 72"	DS2472	\$767	\$815	\$713
30" x 72"	DS3072	N/A	\$841	\$845
2-Seat, Single-Sided		Acrylic	Fabric	Markerboard
12" x 48"	DS1248	\$628	\$752	\$538
18" x 48"	DS1848	\$886	\$1,004	\$744
24" x 48"	DS2448	\$1,024	\$1,078	\$954
30" x 48"	DS3048	N/A	\$1,332	\$1,130
12" x 60"	DS1260	\$814	\$886	\$696
18" x 60"	DS1860	\$1,134	\$1,172	\$954
24" x 60"	DS2460	\$1,306	\$1,354	\$1,218
30" x 60"	DS3060	N/A	\$1,602	\$1,438
12" x 72"	DS1272	\$942	\$978	\$800
18" x 72"	DS1872	\$1,222	\$1,298	\$1,118
24" x 72"	DS2472	\$1,534	\$1,630	\$1,426
30" x 72"	DS3072	N/A	\$1,682	\$1,690
3-Seat, Single-Sided		Acrylic	Fabric	Markerboard
12" x 48"	DS1248	\$942	\$1,128	\$807
18" x 48"	DS1848	\$1,329	\$1,506	\$1,116
24" x 48"	DS2448	\$1,536	\$1,617	\$1,431
30" x 48"	DS3048	N/A	\$1,998	\$1,695
12" x 60"	DS1260	\$1,221	\$1,329	\$1,044
18" x 60"	DS1860	\$1,701	\$1,758	\$1,431
24" x 60"	DS2460	\$1,959	\$2,031	\$1,827
30" x 60"	DS3060	N/A	\$2,403	\$2,157
12" x 72"	DS1272	\$1,413	\$1,467	\$1,200
18" x 72"	DS1872	\$1,833	\$1,947	\$1,677
24" x 72"	DS2472	\$2,301	\$2,445	\$2,139
30" x 72"	DS3072	N/A	\$2,523	\$2,535

4. Size (Cont.)

Screen Size (H x L)	Code	Grade 1 Price		
4-Seat, Single-Sided		Acrylic	Fabric	Markerboard
12" x 48"	DS1248	\$1,256	\$1,504	\$1,076
18" x 48"	DS1848	\$1,772	\$2,008	\$1,488
24" x 48"	DS2448	\$2,048	\$2,156	\$1,908
30" x 48"	DS3048	N/A	\$2,664	\$2,260
12" x 60"	DS1260	\$1,628	\$1,772	\$1,392
18" x 60"	DS1860	\$2,268	\$2,344	\$1,908
24" x 60"	DS2460	\$2,612	\$2,708	\$2,436
30" x 60"	DS3060	N/A	\$3,204	\$2,876
12" x 72"	DS1272	\$1,884	\$1,956	\$1,600
18" x 72"	DS1872	\$2,444	\$2,596	\$2,236
24" x 72"	DS2472	\$3,068	\$3,260	\$2,852
30" x 72"	DS3072	N/A	\$3,364	\$3,380
5-Seat, Single-Sided		Acrylic	Fabric	Markerboard
12" x 48"	DS1248	\$1,570	\$1,880	\$1,345
18" x 48"	DS1848	\$2,215	\$2,510	\$1,860
24" x 48"	DS2448	\$2,560	\$2,695	\$2,385
30" x 48"	DS3048	N/A	\$3,330	\$2,825
12" x 60"	DS1260	\$2,035	\$2,215	\$1,740
18" x 60"	DS1860	\$2,835	\$2,930	\$2,385
24" x 60"	DS2460	\$3,265	\$3,385	\$3,045
30" x 60"	DS3060	N/A	\$4,005	\$3,595
12" x 72"	DS1272	\$2,355	\$2,445	\$2,000
18" x 72"	DS1872	\$3,055	\$3,245	\$2,795
24" x 72"	DS2472	\$3,835	\$4,075	\$3,565
30" x 72"	DS3072	N/A	\$4,205	\$4,225
2-Seat, Back-to-Back		Acrylic	Fabric	Markerboard
12" x 48"	DS1248	\$314	\$376	\$269
18" x 48"	DS1848	\$443	\$502	\$372
24" x 48"	DS2448	\$512	\$539	\$477
30" x 48"	DS3048	N/A	\$666	\$565
12" x 60"	DS1260	\$407	\$443	\$348
18" x 60"	DS1860	\$567	\$586	\$477
24" x 60"	DS2460	\$653	\$677	\$609
30" x 60"	DS3060	N/A	\$801	\$719
12" x 72"	DS1272	\$471	\$489	\$400
18" x 72"	DS1872	\$611	\$649	\$559
24" x 72"	DS2472	\$767	\$815	\$713
30" x 72"	DS3072	N/A	\$841	\$845

4. Size (Cont.)

Screen Size (H x L)	Code	Grade 1 Price		
4-Seat, Back-to-Back		Acrylic	Fabric	Markerboard
12" x 48"	DS1248	\$628	\$752	\$538
18" x 48"	DS1848	\$886	\$1,004	\$744
24" x 48"	DS2448	\$1,024	\$1,078	\$954
30" x 48"	DS3048	N/A	\$1,332	\$1,130
12" x 60"	DS1260	\$814	\$886	\$696
18" x 60"	DS1860	\$1,134	\$1,172	\$954
24" x 60"	DS2460	\$1,306	\$1,354	\$1,218
30" x 60"	DS3060	N/A	\$1,602	\$1,438
12" x 72"	DS1272	\$942	\$978	\$800
18" x 72"	DS1872	\$1,222	\$1,298	\$1,118
24" x 72"	DS2472	\$1,534	\$1,630	\$1,426
30" x 72"	DS3072	N/A	\$1,682	\$1,690
6-Seat, Back-to-Back		Acrylic	Fabric	Markerboard
12" x 48"	DS1248	\$942	\$1,128	\$807
18" x 48"	DS1848	\$1,329	\$1,506	\$1,116
24" x 48"	DS2448	\$1,536	\$1,617	\$1,431
30" x 48"	DS3048	N/A	\$1,998	\$1,695
12" x 60"	DS1260	\$1,221	\$1,329	\$1,044
18" x 60"	DS1860	\$1,701	\$1,758	\$1,431
24" x 60"	DS2460	\$1,959	\$2,031	\$1,827
30" x 60"	DS3060	N/A	\$2,403	\$2,157
12" x 72"	DS1272	\$1,413	\$1,467	\$1,200
18" x 72"	DS1872	\$1,833	\$1,947	\$1,677
24" x 72"	DS2472	\$2,301	\$2,445	\$2,139
30" x 72"	DS3072	N/A	\$2,523	\$2,535
8-Seat, Back-to-Back		Acrylic	Fabric	Markerboard
12" x 48"	DS1248	\$1,256	\$1,504	\$1,076
18" x 48"	DS1848	\$1,772	\$2,008	\$1,488
24" x 48"	DS2448	\$2,048	\$2,156	\$1,908
30" x 48"	DS3048	N/A	\$2,664	\$2,260
12" x 60"	DS1260	\$1,628	\$1,772	\$1,392
18" x 60"	DS1860	\$2,268	\$2,344	\$1,908
24" x 60"	DS2460	\$2,612	\$2,708	\$2,436
30" x 60"	DS3060	N/A	\$3,204	\$2,876
12" x 72"	DS1272	\$1,884	\$1,956	\$1,600
18" x 72"	DS1872	\$2,444	\$2,596	\$2,236
24" x 72"	DS2472	\$3,068	\$3,260	\$2,852
30" x 72"	DS3072	N/A	\$3,364	\$3,380

EFFECTIVE NOVEMBER 4, 2024

4. Size (Cont.)

Screen Size (H x L)	Code	Grade 1 Price		
		Acrylic	Fabric	Markerboard
10-Seat, Back-to-Back				
12" x 48"	DS1248	\$1,570	\$1,880	\$1,345
18" x 48"	DS1848	\$2,215	\$2,510	\$1,860
24" x 48"	DS2448	\$2,560	\$2,695	\$2,385
30" x 48"	DS3048	N/A	\$3,330	\$2,825
12" x 60"	DS1260	\$2,035	\$2,215	\$1,740
18" x 60"	DS1860	\$2,835	\$2,930	\$2,385
24" x 60"	DS2460	\$3,265	\$3,385	\$3,045
30" x 60"	DS3060	N/A	\$4,005	\$3,595
12" x 72"	DS1272	\$2,355	\$2,445	\$2,000
18" x 72"	DS1872	\$3,055	\$3,245	\$2,795
24" x 72"	DS2472	\$3,835	\$4,075	\$3,565
30" x 72"	DS3072	N/A	\$4,205	\$4,225

SPECIFICATIONS

	3242 TW42 42" Beam	3242 TW60 60" Beam	3242 TW72 72" Beam
Dimensions			
Beam Length (With End Cap)	48.75"	60.75"	72.75"
Beam Height	5.8"	5.8"	5.8"
Beam Width	2.5"	2.5"	2.5"
Overall Height	24.1"	24.1"	24.1"
Height From Floor to Beam	18.3"	18.3"	18.3"
Leg Width	2.5"	2.5"	2.5"
Foot Width	1.6"	1.6"	1.6"
Foot Length	14.5"	14.5"	14.5"
Length From End to Duplex	19.7"	25.7"	31.7"

5. Clamp Color

Paint Color	Code	Price
Silver	BF01	+ \$0
White	BF02	+ \$0
Black	BF03	+ \$0

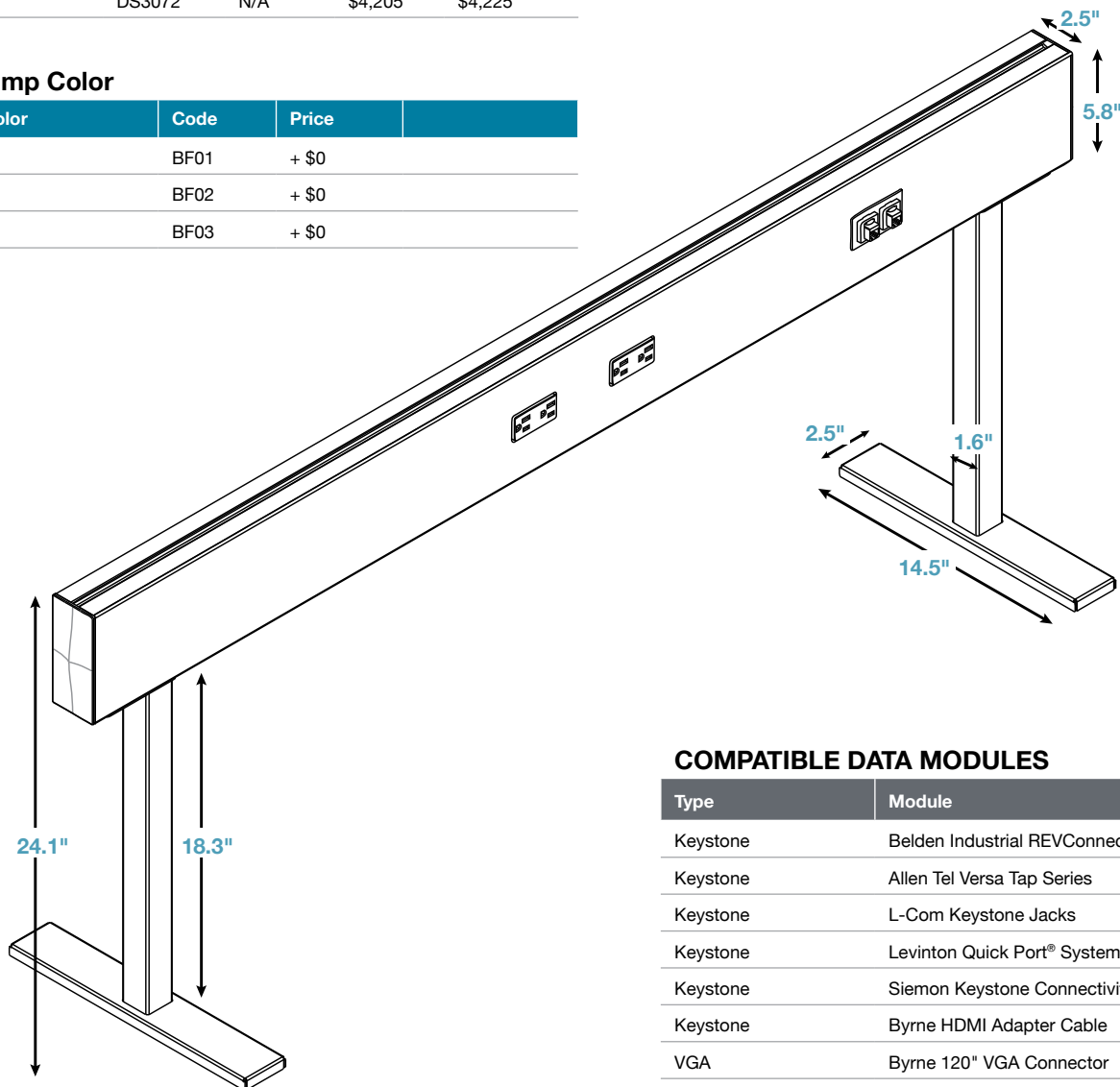

COMPATIBLE DATA MODULES

Type	Module
Keystone	Belden Industrial REVConnect
Keystone	Allen Tel Versa Tap Series
Keystone	L-Com Keystone Jacks
Keystone	Levinton Quick Port® System Adapters and Jacks
Keystone	Siemon Keystone Connectivity Solutions
Keystone	Byrne HDMI Adapter Cable
VGA	Byrne 120" VGA Connector

EFFECTIVE NOVEMBER 4, 2024

1. Product

Category	Code	Price
Stand-Alone Components for Power Beams	3249	Priced by Type
Type	Code	Price
Electrical		

Duplex Receptacle	ATC04	\$40	
-------------------	-------	------	---

Wire Management

Horizontal Wire Tray	ATC01 WM01	+ \$105	
----------------------	---------------	---------	---

Horizontal Wire Tray and Vertical Wire Manager	ATC01 WM06	+ \$210	
--	---------------	---------	--

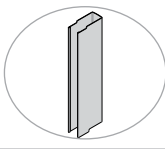
Power Infeed Cover	ATC02 VLC1	+ \$63	
--------------------	---------------	--------	---

2. Circuit (For Duplexes Only)

Circuit Number	Code	Price
Circuit 1	DC1	+ \$0
Circuit 2	DC2	+ \$0
Circuit 3	DC3	+ \$0
Circuit 4	DC4	+ \$0
Title 24 (Controlled)		
Circuit 1	DC1C	+ \$7
Circuit 2	DC2C	+ \$7
Circuit 3	DC3C	+ \$7
Circuit 4	DC4C	+ \$7

3. Color

Wire Management Color	Code	Price
Silver	BF01	+ \$0
White	BF02	+ \$0
Black	BF03	+ \$0

Vertical wire managers are only available in black. Color will apply to the horizontal wire tray only.

Screens

WORKSURFACE | MODESTY
FREESTANDING | MOBILE | CAFÉ
SEATING | TRANSACTION | TRIFOLD

Doodle

MARKERBOARD WORKSURFACE SCREEN

Write away (right away).

From big idea-making to simple note-taking, stay on task with a tool that helps you work. Our Doodle markerboards provide essential privacy as a screen while promoting impactful productivity as a convenient place to write.



12" x 23" Middle Mount
Table not included. See [page 506](#) for Tensor.
Chairs not included. See [page 101](#) for Ioniq.

EFFECTIVE NOVEMBER 4, 2024

Featured Models

12" x 23" MIDDLE :: \$192

12" x 23" markerboard screen,
middle mount

24" x 60" EDGE :: \$657

24" x 60" markerboard screen,
edge mount

30" x 60" MIDWAY :: \$711

30" x 60" markerboard screen,
midway mount

MARKERBOARD WORKSURFACE SCREEN

Features

- Non-ghosting, durable writing surface can withstand endless scribbles and wipes
- Compatible with dry erase and wet erase markers
- Slim, straightforward design mixes well with any workspace
- Height options: 12, 18 and 24 inches; 30 inches available for midway and height-adjustable mounts
- Width options: 17 to 72 inches
- Compatible with most mounts, including edge, middle, top, midway, freestanding, panel and height-adjustable

1. Product

Product Type	Code	Price
Worksurface Screen	3090	Priced by Size

2. Material

Material	Code	Price
Markerboard	DT301	Priced by Size

3. Size

Screen Size (H x W)	Code	Price
12" High Screens		
12" x 17"	DS1217	\$79
12" x 18"	DS1218	\$79
12" x 21"	DS1221	\$104
12" x 22"	DS1222	\$104
12" x 23"	DS1223	\$104
12" x 24"	DS1224	\$104
12" x 27"	DS1227	\$129
12" x 28"	DS1228	\$129
12" x 29"	DS1229	\$129
12" x 30"	DS1230	\$129
12" x 36"	DS1236	\$160
12" x 40"	DS1240	\$185
12" x 42"	DS1242	\$185
12" x 46"	DS1246	\$213
12" x 48"	DS1248	\$213

3. Size (Cont.)

Screen Size (H x W)	Code	Price
12" High Screens (Cont.)		
12" x 52"	DS1252	\$239
12" x 54"	DS1254	\$239
12" x 58"	DS1258	\$264
12" x 60"	DS1260	\$264
12" x 64"	DS1264	\$290
12" x 66"	DS1266	\$290
12" x 70"	DS1270	\$316
12" x 72"	DS1272	\$316
18" Wide Side Screen		
18" x 17"	DS1817	\$114
18" x 18"	DS1818	\$114
18" x 21"	DS1821	\$155
18" x 22"	DS1822	\$155
18" x 23"	DS1823	\$155
18" x 24"	DS1824	\$155
18" x 27"	DS1827	\$194
18" x 28"	DS1828	\$194
18" x 29"	DS1829	\$194
18" x 30"	DS1830	\$194
18" x 36"	DS1836	\$239
18" x 40"	DS1840	\$277
18" x 42"	DS1842	\$277
18" x 46"	DS1846	\$316
18" x 48"	DS1848	\$316
18" x 52"	DS1852	\$356
18" x 54"	DS1854	\$356
18" x 58"	DS1858	\$393
18" x 60"	DS1860	\$393
18" x 64"	DS1864	\$433
18" x 66"	DS1866	\$433
18" x 70"	DS1870	\$475
18" x 72"	DS1872	\$475

**MARKERBOARD
WORKSURFACE SCREEN**

3. Size (Cont.)





Screen Size (H x W)	Code	Price
24" Tall Screen		
24" x 17"	DS2417	\$151
24" x 18"	DS2418	\$151
24" x 21"	DS2421	\$204
24" x 22"	DS2422	\$204
24" x 23"	DS2423	\$204
24" x 24"	DS2424	\$204
24" x 27"	DS2427	\$255
24" x 28"	DS2428	\$255
24" x 29"	DS2429	\$255
24" x 30"	DS2430	\$255
24" x 36"	DS2436	\$316
24" x 40"	DS2440	\$368
24" x 42"	DS2442	\$368
24" x 46"	DS2446	\$421
24" x 48"	DS2448	\$421
24" x 52"	DS2452	\$475
24" x 54"	DS2454	\$475
24" x 58"	DS2458	\$525
24" x 60"	DS2460	\$525
24" x 64"	DS2464	\$577
24" x 66"	DS2466	\$577
24" x 70"	DS2470	\$629
24" x 72"	DS2472	\$629
30" Tall Side Screen		
30" x 24"	DS3024	\$255
30" x 30"	DS3030	\$319
30" x 36"	DS3036	\$382
30" x 40"	DS3040	\$447
30" x 42"	DS3042	\$447
30" x 46"	DS3046	\$509
30" x 48"	DS3048	\$509
30" x 52"	DS3052	\$572
30" x 54"	DS3054	\$572
30" x 58"	DS3058	\$635
30" x 60"	DS3060	\$635
30" x 64"	DS3064	\$697
30" x 66"	DS3066	\$697
30" x 70"	DS3070	\$761
30" x 72"	DS3072	\$761

3. Size (Cont.)

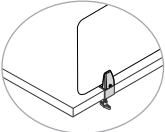
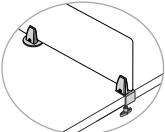
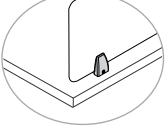
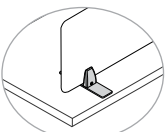

Screen Size (H x W)	Code	Price
36" Tall Side Screen		
36" x 24"	DS3624	\$316
36" x 30"	DS3630	\$382
36" x 36"	DS3636	\$450
36" x 40"	DS3640	\$518
36" x 42"	DS3642	\$518
36" x 46"	DS3646	\$586
36" x 48"	DS3648	\$586
36" x 52"	DS3652	\$654
36" x 54"	DS3654	\$654
36" x 58"	DS3658	\$722
36" x 60"	DS3660	\$722
36" x 64"	DS3664	\$790
36" x 66"	DS3666	\$790
36" x 70"	DS3670	\$858
36" x 72"	DS3672	\$858

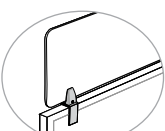
**MARKERBOARD
WORKSURFACE SCREEN**

4. Mount

Mount Style	Code	Price	
Protective/Privacy			
Edge Mount Compatibility: 17"-54" Screen Width 12"-24" Screen Height	MT1	+ \$88	
Edge Mount Compatibility: 60"-72" Screen Width 12"-24" Screen Height	MT1	+ \$132	
Middle Mount Compatibility: 17"-29" Screen Width 12"-24" Screen Height	MT2	+ \$88	
Top Mount Compatibility: 17"-54" Screen Width 12"-24" Screen Height	MT3	+ \$56	
Top Mount Compatibility: 60"-72" Screen Width 12"-24" Screen Height	MT3	+ \$84	
Freestanding Mount Compatibility: 17"-54" Screen Width 12"-24" Screen Height	MT4	+ \$88	
Freestanding Mount Compatibility: 60"-72" Screen Width 12"-24" Screen Height	MT4	+ \$132	
Small Panel Mount Compatibility: 1.5"-2.3" Panel Depth 17"-54" Screen Width 12"-24" Screen Height	MT9	+ \$88	
Small Panel Mount Compatibility: 1.5"-2.3" Panel Depth 60"-72" Screen Width 12"-24" Screen Height	MT9	+ \$132	
Large Panel Mount Compatibility: 2.3"-3.7" Panel Depth 17"-54" Screen Width 12"-24" Screen Height	MT10	+ \$88	
Large Panel Mount Compatibility: 2.3"-3.7" Panel Depth 60"-72" Screen Width 12"-24" Screen Height	MT10	+ \$132	

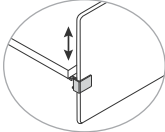
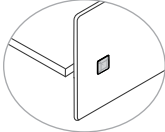
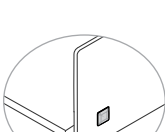
4. Mount (Cont.)

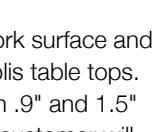
Mount Style	Code	Price	
Protective/Privacy + Modesty			
Height-Adjustable Mount Compatibility: 24"-60" Screen Width 18"-36" Screen Height	MT6	+ \$80	
Midway Mount Compatibility: 24"-54" Screen Width 24"-36" Screen Height	MT5	+ \$38	
Midway Mount Compatibility: 58"-72" Screen Width 24"-36" Screen Height	MT5	+ \$76	
Midway Mount – High Compatibility: 24"-54" Screen Width 18"-30" Screen Height	MT5H	+ \$38	
Midway Mount – High Compatibility: 24" - 72" Screen Width 18" - 30" Screen Height	MT5H	+ \$76	

NOTE:

Edge Mounts and Middle Mounts clamp to the work surface and are designed to be used with the standard Exemplis table tops. They will function, as designed, with tops between .9" and 1.5" thick. If the worksurface is less than .9" thick the customer will be responsible to add a spacer to bring the thickness into the allowable range

Modesty

LAMINATE SCREENS

Versatile peace of mind.

We all need our own space. Increase office and employee privacy with our selection of modesty screens that attach right onto our desks and benches. In addition, shield cords, wires and more from sight for a clean and organized workspace.



60" Laminate Modesty Screen
Featured with Sandalwood laminate
Table not included. See [page 457](#) for Parallon Fixed-Top

EFFECTIVE NOVEMBER 4, 2024

Featured Models

48" :: \$265

Modesty Screen, 10" x 48",
grade 1 laminate

60" :: \$313

Modesty Screen, 10" x 60",
grade 1 laminate

72" :: \$361

Modesty Screen, 10" x 72",
grade 1 laminate

Features

- Extra privacy for users
- 28 durable laminate options to fit your style
- Hinged mount

1. Product

Product Type	Code	Price
Modesty Screen	3093	Priced by Size

2. Material

Material Type	Code	Price
Laminate	DT501	Priced by Size

Laminate	Code	Price
Laminate Grade 1		

Ankara Cherry	MPC18	+ \$0
Black	MPC19	+ \$0
Brazilian Walnut	MPC20	+ \$0
Cabinet Maple	MPC21	+ \$0
Driftwood	MPC23	+ \$0
Folkstone Grey	MPC24	+ \$0
Libretti	MPC25	+ \$0
Queenston Oak	MPC26	+ \$0
Sandalwood	MPC27	+ \$0
Walnut Amati	MPC28	+ \$0
White	MPC29	+ \$0

Laminate	Code	Price
Laminate Grade 2		

Neo Walnut	MPC50	+ \$0
Grey Elm	MPC51	+ \$0
Skyline Walnut	MPC15	+ \$0
Kingswood Walnut	MPC53	+ \$0
Uptown Walnut	MPC14	+ \$0
Colombian Walnut	MPC55	+ \$0
Manitoba Maple	MPC56	+ \$0
Tuscan Walnut	MPC57	+ \$0
Field Elm	MPC13	+ \$0
Steel Mesh	MPC59	+ \$0
Portico Teak	MPC60	+ \$0
Platinum	MPC61	+ \$0
Grey	MPC62	+ \$0

WORKSURFACE SCREEN

2. Material (Cont.)

Laminate	Code	Price
Laminate Grade 2		
Frosty White	MPC16	+ \$0
Crisp Linen	MPC64	+ \$0
Classic Linen	MPC17	+ \$0
Designer White	MPC66	+ \$0

3. Size

Screen Size (H x W)	Code	Price	
For Rectangular Tables		Grade 1 Laminate	Grade 2 Laminate
10" x 36"	DS1036	\$217	\$326
10" x 40"	DS1040	\$254	\$381
10" x 42"	DS1042	\$254	\$381
10" x 46"	DS1046	\$265	\$398
10" x 48"	DS1048	\$265	\$398
10" x 52"	DS1052	\$289	\$434
10" x 54"	DS1054	\$289	\$434
10" x 58"	DS1058	\$313	\$470
10" x 60"	DS1060	\$313	\$470
10" x 64"	DS1064	\$338	\$507
10" x 66"	DS1066	\$338	\$507
10" x 70"	DS1070	\$361	\$542
10" x 72"	DS1072	\$361	\$542
For Trapezoid Tables			
10" x 25"	DS1025	\$265	\$398
10" x 31"	DS1031	\$313	\$470

4. Mount

Mount Style	Code	Price
-------------	------	-------

Modesty Screen Mount
 Compatibility:
 36"-72" Screen Width
 10" Screen Height

MT8

+ \$0

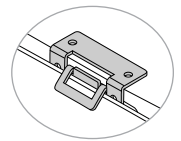

Modesty screens include the cost of the mount.

Motif

FABRIC WORKSURFACE SCREEN

Social distancing with style.

Divide and conquer the challenges of the "new normal" with Motif. Our collection of modern, well-designed privacy and modesty screens help you fashion spaces that are safe, secluded and color coordinated with the entire office.



30" x 60" Screen With Midway Mount
Table not included; see [page 506](#) for Tensor.

EFFECTIVE NOVEMBER 4, 2024

Featured Models

12" x 23" EDGE :: \$277

12" x 23" fabric screen, edge mount,
grade 1 textile

30" x 48" HA :: \$690

30" x 48" fabric screen,
height-adjustable mount, grade 1 textile

30" x 60" MIDWAY :: \$793

30" x 60" fabric screen, midway mount,
grade 1 textile

Features

- Get customized privacy with durable fabrics designed to heal from pins, thumbtacks and more
- Find privacy + protection with fabrics that are bleach-cleanable, helping protect against COVID-19
- Eco-friendly, single-piece construction features a HexaCore honeycomb center, providing rigidity with less weight
- Height options include 12, 18, and 24 inches; 30 inches available for midway and height-adjustable mounts
- Width options range from 17 to 72 inches (in six-inch increments)
- Compatible with most mounts, including edge, middle, top, midway, freestanding, panel and height-adjustable

1. Product

Screen Size (H x W)	Code	Price
Screen	3090	Priced by Size

2. Material

Material Type	Code	Price
Fabric/Vinyl	DT701	Priced by Size
Material Grade	Code	Price
Fabric/Vinyl Grade 1	FG1/VG1	Priced by Size
Fabric/Vinyl Grade 2	FG2/VG2	Priced by Size
Fabric/Vinyl Grade 3	FG3/VG3	Priced by Size
Fabric/Vinyl Grade 4	FG4/VG4	Priced by Size
Fabric/Vinyl Grade 5	FG5/VG5	Priced by Size
Fabric/Vinyl Grade 6	FG6/VG6	Priced by Size
Fabric/Vinyl Grade 7	FG7/VG7	Priced by Size

3. Size

Screen Size	Code	Price							
12" Tall Screens		Base Price	Grade 1	Grade 2	Grade 3	Grade 4	Grade 5	Grade 6	Grade 7
12" x 17"	DS1217	\$171	+\$0	+\$7	+\$18	+\$31	+\$54	+\$76	+\$99
12" x 18"	DS1218	\$171	+\$0	+\$7	+\$18	+\$31	+\$54	+\$76	+\$99
12" x 21"	DS1221	\$189	+\$0	+\$9	+\$23	+\$40	+\$69	+\$98	+\$127
12" x 22"	DS1222	\$189	+\$0	+\$9	+\$23	+\$40	+\$69	+\$98	+\$127
12" x 23"	DS1223	\$189	+\$0	+\$9	+\$23	+\$40	+\$69	+\$98	+\$127
12" x 24"	DS1224	\$189	+\$0	+\$9	+\$23	+\$40	+\$69	+\$98	+\$127
12" x 27"	DS1227	\$209	+\$0	+\$11	+\$28	+\$50	+\$85	+\$121	+\$157
12" x 28"	DS1228	\$209	+\$0	+\$11	+\$28	+\$50	+\$85	+\$121	+\$157
12" x 29"	DS1229	\$209	+\$0	+\$11	+\$28	+\$50	+\$85	+\$121	+\$157
12" x 30"	DS1230	\$209	+\$0	+\$11	+\$28	+\$50	+\$85	+\$121	+\$157
12" x 36"	DS1236	\$246	+\$0	+\$13	+\$35	+\$60	+\$104	+\$147	+\$190
12" x 40"	DS1240	\$284	+\$0	+\$15	+\$40	+\$70	+\$120	+\$170	+\$220
12" x 42"	DS1242	\$284	+\$0	+\$15	+\$40	+\$70	+\$120	+\$170	+\$220
12" x 46"	DS1246	\$320	+\$0	+\$17	+\$45	+\$79	+\$136	+\$193	+\$250
12" x 48"	DS1248	\$320	+\$0	+\$17	+\$45	+\$79	+\$136	+\$193	+\$250
12" x 52"	DS1252	\$340	+\$0	+\$19	+\$50	+\$88	+\$152	+\$215	+\$278
12" x 54"	DS1254	\$340	+\$0	+\$19	+\$50	+\$88	+\$152	+\$215	+\$278
12" x 58"	DS1258	\$359	+\$0	+\$21	+\$56	+\$98	+\$168	+\$238	+\$308
12" x 60"	DS1260	\$359	+\$0	+\$21	+\$56	+\$98	+\$168	+\$238	+\$308
12" x 64"	DS1264	\$381	+\$0	+\$23	+\$61	+\$107	+\$184	+\$261	+\$338
12" x 66"	DS1266	\$381	+\$0	+\$23	+\$61	+\$107	+\$184	+\$261	+\$338
12" x 70"	DS1270	\$405	+\$0	+\$25	+\$66	+\$116	+\$200	+\$283	+\$366
12" x 72"	DS1272	\$405	+\$0	+\$25	+\$66	+\$116	+\$200	+\$283	+\$366
18" Tall Screens		Base Price	Grade 1	Grade 2	Grade 3	Grade 4	Grade 5	Grade 6	Grade 7
18" x 17"	DS1817	\$239	+\$0	+\$7	+\$18	+\$31	+\$54	+\$76	+\$99
18" x 18"	DS1818	\$239	+\$0	+\$7	+\$18	+\$31	+\$54	+\$76	+\$99
18" x 21"	DS1821	\$265	+\$0	+\$9	+\$23	+\$40	+\$69	+\$98	+\$127
18" x 22"	DS1822	\$265	+\$0	+\$9	+\$23	+\$40	+\$69	+\$98	+\$127
18" x 23"	DS1823	\$265	+\$0	+\$9	+\$23	+\$40	+\$69	+\$98	+\$127
18" x 24"	DS1824	\$265	+\$0	+\$9	+\$23	+\$40	+\$69	+\$98	+\$127
18" x 27"	DS1827	\$293	+\$0	+\$11	+\$28	+\$50	+\$85	+\$121	+\$157
18" x 28"	DS1828	\$293	+\$0	+\$11	+\$28	+\$50	+\$85	+\$121	+\$157
18" x 29"	DS1829	\$293	+\$0	+\$11	+\$28	+\$50	+\$85	+\$121	+\$157
18" x 30"	DS1830	\$293	+\$0	+\$11	+\$28	+\$50	+\$85	+\$121	+\$157
18" x 36"	DS1836	\$344	+\$0	+\$13	+\$35	+\$60	+\$104	+\$147	+\$190
18" x 40"	DS1840	\$395	+\$0	+\$15	+\$40	+\$70	+\$120	+\$170	+\$220
18" x 42"	DS1842	\$395	+\$0	+\$15	+\$40	+\$70	+\$120	+\$170	+\$220
18" x 46"	DS1846	\$446	+\$0	+\$17	+\$45	+\$79	+\$136	+\$193	+\$250
18" x 48"	DS1848	\$446	+\$0	+\$17	+\$45	+\$79	+\$136	+\$193	+\$250
18" x 52"	DS1852	\$476	+\$0	+\$19	+\$50	+\$88	+\$152	+\$215	+\$278

3. Size (Cont.)

Material Grade	Code	Price							
18" Tall Screens		Base Price	Grade 1	Grade 2	Grade 3	Grade 4	Grade 5	Grade 6	Grade 7
18" x 54"	DS1854	\$476	+\$0	+\$19	+\$50	+\$88	+\$152	+\$215	+\$278
18" x 58"	DS1858	\$502	+\$0	+\$21	+\$56	+\$98	+\$168	+\$238	+\$308
18" x 60"	DS1860	\$502	+\$0	+\$21	+\$56	+\$98	+\$168	+\$238	+\$308
18" x 64"	DS1864	\$534	+\$0	+\$23	+\$61	+\$107	+\$184	+\$261	+\$338
18" x 66"	DS1866	\$534	+\$0	+\$23	+\$61	+\$107	+\$184	+\$261	+\$338
18" x 70"	DS1870	\$565	+\$0	+\$25	+\$66	+\$116	+\$200	+\$283	+\$366
18" x 72"	DS1872	\$565	+\$0	+\$25	+\$66	+\$116	+\$200	+\$283	+\$366
24" Tall Screens		Base Price	Grade 1	Grade 2	Grade 3	Grade 4	Grade 5	Grade 6	Grade 7
24" x 17"	DS2417	\$288	+\$0	+\$13	+\$36	+\$63	+\$107	+\$152	+\$197
24" x 18"	DS2418	\$288	+\$0	+\$13	+\$36	+\$63	+\$107	+\$152	+\$197
24" x 21"	DS2421	\$319	+\$0	+\$17	+\$46	+\$81	+\$138	+\$196	+\$253
24" x 22"	DS2422	\$319	+\$0	+\$17	+\$46	+\$81	+\$138	+\$196	+\$253
24" x 23"	DS2423	\$319	+\$0	+\$17	+\$46	+\$81	+\$138	+\$196	+\$253
24" x 24"	DS2424	\$319	+\$0	+\$18	+\$48	+\$84	+\$144	+\$204	+\$264
24" x 27"	DS2427	\$354	+\$0	+\$21	+\$57	+\$99	+\$170	+\$241	+\$312
24" x 28"	DS2428	\$354	+\$0	+\$21	+\$57	+\$99	+\$170	+\$241	+\$312
24" x 29"	DS2429	\$354	+\$0	+\$21	+\$57	+\$99	+\$170	+\$241	+\$312
24" x 30"	DS2430	\$354	+\$0	+\$22	+\$58	+\$102	+\$176	+\$249	+\$322
24" x 36"	DS2436	\$392	+\$0	+\$26	+\$69	+\$121	+\$208	+\$295	+\$382
24" x 40"	DS2440	\$435	+\$0	+\$30	+\$80	+\$140	+\$240	+\$340	+\$440
24" x 42"	DS2442	\$435	+\$0	+\$30	+\$80	+\$140	+\$240	+\$340	+\$440
24" x 46"	DS2446	\$483	+\$0	+\$34	+\$90	+\$158	+\$272	+\$385	+\$498
24" x 48"	DS2448	\$483	+\$0	+\$34	+\$90	+\$158	+\$272	+\$385	+\$498
24" x 52"	DS2452	\$535	+\$0	+\$38	+\$101	+\$177	+\$304	+\$431	+\$558
24" x 54"	DS2454	\$535	+\$0	+\$38	+\$101	+\$177	+\$304	+\$431	+\$558
24" x 58"	DS2458	\$593	+\$0	+\$42	+\$112	+\$196	+\$336	+\$476	+\$616
24" x 60"	DS2460	\$593	+\$0	+\$42	+\$112	+\$196	+\$336	+\$476	+\$616
24" x 64"	DS2464	\$657	+\$0	+\$46	+\$122	+\$214	+\$368	+\$521	+\$674
24" x 66"	DS2466	\$657	+\$0	+\$46	+\$122	+\$214	+\$368	+\$521	+\$674
24" x 70"	DS2470	\$731	+\$0	+\$50	+\$133	+\$233	+\$400	+\$567	+\$734
24" x 72"	DS2472	\$731	+\$0	+\$50	+\$133	+\$233	+\$400	+\$567	+\$734

3. Size (Cont.)

Material Grade	Code	Price							
30" Tall Screens		Base Price	Grade 1	Grade 2	Grade 3	Grade 4	Grade 5	Grade 6	Grade 7
30" x 24"	DS3024	\$405	+\$0	+\$18	+\$48	+\$84	+\$144	+\$204	+\$264
30" x 30"	DS3030	\$447	+\$0	+\$22	+\$58	+\$102	+\$176	+\$249	+\$322
30" x 36"	DS3036	\$497	+\$0	+\$26	+\$69	+\$121	+\$208	+\$295	+\$382
30" x 40"	DS3040	\$552	+\$0	+\$30	+\$80	+\$140	+\$240	+\$340	+\$440
30" x 42"	DS3042	\$552	+\$0	+\$30	+\$80	+\$140	+\$240	+\$340	+\$440
30" x 46"	DS3046	\$610	+\$0	+\$34	+\$90	+\$158	+\$272	+\$385	+\$498
30" x 48"	DS3048	\$610	+\$0	+\$34	+\$90	+\$158	+\$272	+\$385	+\$498
30" x 52"	DS3052	\$646	+\$0	+\$38	+\$101	+\$177	+\$304	+\$431	+\$558
30" x 54"	DS3054	\$646	+\$0	+\$38	+\$101	+\$177	+\$304	+\$431	+\$558
30" x 58"	DS3058	\$717	+\$0	+\$42	+\$112	+\$196	+\$336	+\$476	+\$616
30" x 60"	DS3060	\$717	+\$0	+\$42	+\$112	+\$196	+\$336	+\$476	+\$616
30" x 64"	DS3064	\$738	+\$0	+\$46	+\$122	+\$214	+\$368	+\$521	+\$674
30" x 66"	DS3066	\$738	+\$0	+\$46	+\$122	+\$214	+\$368	+\$521	+\$674
30" x 70"	DS3070	\$757	+\$0	+\$50	+\$133	+\$233	+\$400	+\$567	+\$734
30" x 72"	DS3072	\$757	+\$0	+\$50	+\$133	+\$233	+\$400	+\$567	+\$734
36" Tall Screens		Base Price	Grade 1	Grade 2	Grade 3	Grade 4	Grade 5	Grade 6	Grade 7
36" x 24"	DS3624	\$456	+\$0	+\$18	+\$48	+\$84	+\$144	+\$204	+\$264
36" x 30"	DS3630	\$540	+\$0	+\$22	+\$58	+\$102	+\$176	+\$249	+\$322
36" x 36"	DS3636	\$602	+\$0	+\$26	+\$69	+\$121	+\$208	+\$295	+\$382
36" x 40"	DS3640	\$669	+\$0	+\$30	+\$80	+\$140	+\$240	+\$340	+\$440
36" x 42"	DS3642	\$669	+\$0	+\$30	+\$80	+\$140	+\$240	+\$340	+\$440
36" x 46"	DS3646	\$737	+\$0	+\$34	+\$90	+\$158	+\$272	+\$385	+\$498
36" x 48"	DS3648	\$737	+\$0	+\$34	+\$90	+\$158	+\$272	+\$385	+\$498
36" x 52"	DS3652	\$757	+\$0	+\$38	+\$101	+\$177	+\$304	+\$431	+\$558
36" x 54"	DS3654	\$757	+\$0	+\$38	+\$101	+\$177	+\$304	+\$431	+\$558
36" x 58"	DS3658	\$841	+\$0	+\$42	+\$112	+\$196	+\$336	+\$476	+\$616
36" x 60"	DS3660	\$841	+\$0	+\$42	+\$112	+\$196	+\$336	+\$476	+\$616
36" x 64"	DS3664	\$900	+\$0	+\$46	+\$122	+\$214	+\$368	+\$521	+\$674
36" x 66"	DS3666	\$900	+\$0	+\$46	+\$122	+\$214	+\$368	+\$521	+\$674
36" x 70"	DS3670	\$990	+\$0	+\$50	+\$133	+\$233	+\$400	+\$567	+\$734
36" x 72"	DS3672	\$990	+\$0	+\$50	+\$133	+\$233	+\$400	+\$567	+\$734

Please reference the [Textile Reference Guide](#) for information on approved textiles for Motif products.

4. Mount

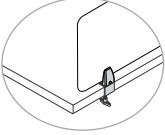
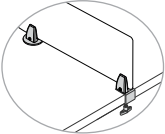
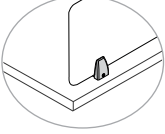
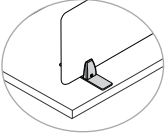
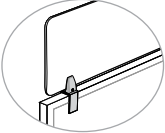
Mount Style	Code	Price	
Protective/Privacy			
Edge Mount Compatibility: 17"-58" Screen Width 12"-24" Screen Height	MT1	+ \$88	
Edge Mount Compatibility: 60"-72" Screen Width 12"-24" Screen Height	MT1	+ \$132	
Middle Mount Compatibility: 17"-29" Screen Width 12"-24" Screen Height	MT2	+ \$88	
Top Mount Compatibility: 17"-58" Screen Width 12"-24" Screen Height	MT3	+ \$56	
Top Mount Compatibility: 60"-72" Screen Width 12"-24" Screen Height	MT3	+ \$84	
Freestanding Mount Compatibility: 17"-58" Screen Width 12"-24" Screen Height	MT4	+ \$88	
Freestanding Mount Compatibility: 60"-72" Screen Width 12"-24" Screen Height	MT4	+ \$132	
Small Panel Mount Compatibility: 1.5"-2.3" Panel Depth 17"-58" Screen Width 12"-24" Screen Height	MT9	+ \$88	
Small Panel Mount Compatibility: 1.5"-2.3" Panel Depth 60"-72" Screen Width 12"-24" Screen Height	MT9	+ \$132	
Large Panel Mount Compatibility: 2.3"-3.7" Panel Depth 17"-58" Screen Width 12"-24" Screen Height	MT10	+ \$88	
Large Panel Mount Compatibility: 2.3"-3.7" Panel Depth 60"-72" Screen Width 12"-24" Screen Height	MT10	+ \$132	

FABRIC WORKSURFACE SCREEN

4. Mount (Cont.)

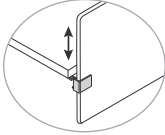
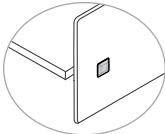
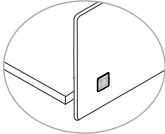
Mount Style	Code	Price	
Protective/Privacy + Modesty			
Height-Adjustable Mount Compatibility: 24"-60" Screen Width 18"-36" Screen Height	MT6	+ \$80	
Midway Mount Compatibility: 24"-58" Screen Width 24"-36" Screen Height	MT5	+ \$38	
Midway Mount Compatibility: 58"-72" Screen Width 24"-36" Screen Height	MT5	+ \$76	
Midway Mount - High Compatibility: 24"-58" Screen Width 18"-30" Screen Height	MT5H	+ \$38	
Midway Mount - High Compatibility: 24" - 72" Screen Width 18" - 30" Screen Height	MT5H	+ \$76	

NOTE:

Edge Mounts and Middle Mounts clamp to the work surface and are designed to be used with the standard Exemplis table tops. They will function, as designed, with tops between .9" and 1.5" thick. If the worksurface is less than .9" thick the customer will be responsible to add a spacer to bring the thickness into the allowable range

Motif

MOBILE + FREESTANDING FABRIC SCREEN

Distance with style.

Now more than ever, our welcoming spaces should be safe—free from contagions, concern and anything that gets in the way of productivity. This collection of mobile and freestanding screens provides the protection and peace of mind you need to work with confidence.

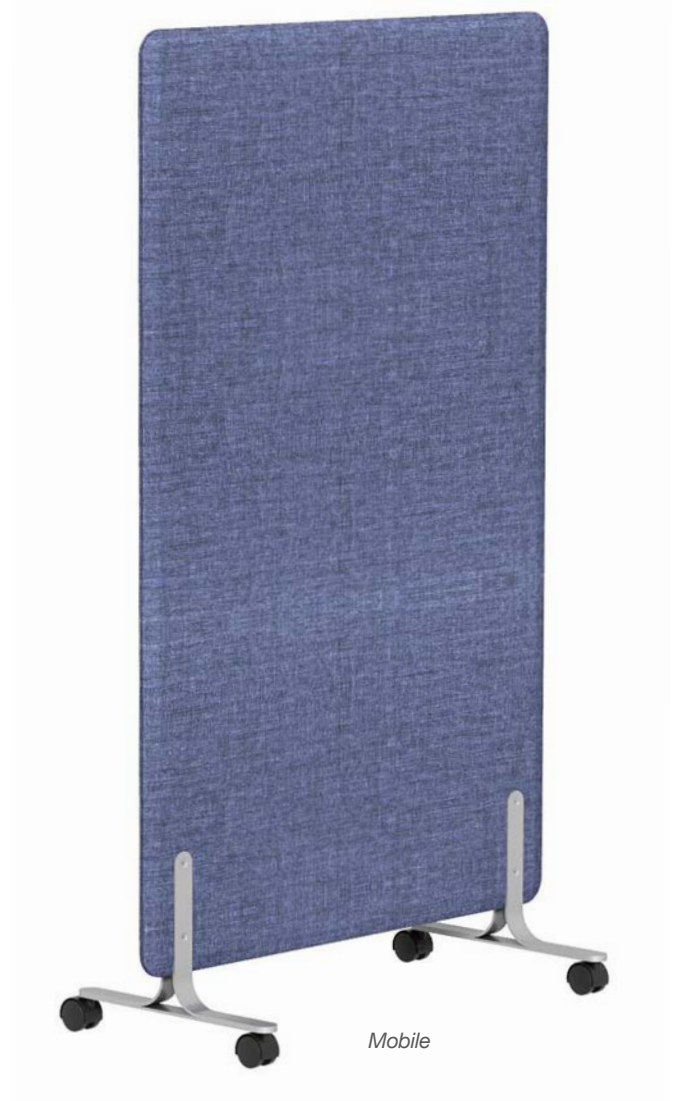

EFFECTIVE NOVEMBER 4, 2024

Featured Models

FREESTANDING :: \$1,047

Freestanding screen with glides, 60" x 36", grade 1 fabric, triangular-shaped feet

MOBILE :: \$1,227

Mobile screen with casters, 60" x 36", grade 1 fabric, T-shaped feet

LARGE MOBILE :: \$1,439

Mobile screen with casters, 48" x 72", grade 1 fabric, T-shaped feet

Features

- Mobile and freestanding screens are an easy-to-deploy solution for environments always in motion
- Quick installation creates safer, color-coordinated spaces in minutes
- Durable fabrics designed to heal from pins, thumbtacks and more
- Find privacy + protection with fabrics that are bleach-cleanable, helping protect against COVID-19
- Eco-friendly, single-piece construction features a Hexacore honeycomb center, providing rigidity with less weight
- Compact foot design allows for easy nesting and almost endless storing
- Black, silver or white frame finish
- Foot styles include freestanding with glides or mobile with casters

1. Product

Product Type	Code	Price
Mobile + Freestanding Screens	3092	Priced by Size

2. Material

Material Type	Code	Price
Fabric/Vinyl	DT701	Priced by Size

Fabric Grade	Code	Price
Fabric/Vinyl Grade 1	FG1/VG1	Priced by Size
Fabric/Vinyl Grade 2	FG2/VG2	Priced by Size
Fabric/Vinyl Grade 3	FG3/VG3	Priced by Size
Fabric/Vinyl Grade 4	FG4/VG4	Priced by Size
Fabric/Vinyl Grade 5	FG5/VG5	Priced by Size
Fabric/Vinyl Grade 6	FG6/VG6	Priced by Size
Fabric/Vinyl Grade 7	FG7/VG7	Priced by Size

3. Size

Screen Size	Code	Price							
53" Tall Screens		Base Price	Grade 1	Grade 2	Grade 3	Grade 4	Grade 5	Grade 6	Grade 7
53" x 30"	DS5330	\$844	+\$0	+\$48	+\$128	+\$224	+\$384	+\$544	+\$704
53" x 36"	DS5336	\$941	+\$0	+\$48	+\$128	+\$224	+\$384	+\$544	+\$704
53" x 42"	DS5342	\$1,037	+\$0	+\$48	+\$128	+\$224	+\$384	+\$544	+\$704
53" x 48"	DS5348	\$1,131	+\$0	+\$48	+\$128	+\$224	+\$384	+\$544	+\$704
60" Tall Screens		Base Price	Grade 1	Grade 2	Grade 3	Grade 4	Grade 5	Grade 6	Grade 7
60" x 30"	DS6030	\$961	+\$0	+\$52	+\$140	+\$245	+\$420	+\$595	+\$770
60" x 36"	DS6036	\$1,047	+\$0	+\$52	+\$140	+\$245	+\$420	+\$595	+\$770
60" x 42"	DS6042	\$1,131	+\$0	+\$52	+\$140	+\$245	+\$420	+\$595	+\$770
60" x 48"	DS6048	\$1,218	+\$0	+\$52	+\$140	+\$245	+\$420	+\$595	+\$770
72" Tall Screens		Base Price	Grade 1	Grade 2	Grade 3	Grade 4	Grade 5	Grade 6	Grade 7
72" x 30"	DS7230	\$1,091	+\$0	+\$63	+\$168	+\$294	+\$504	+\$714	+\$924
72" x 36"	DS7236	\$1,148	+\$0	+\$63	+\$168	+\$294	+\$504	+\$714	+\$924
72" x 42"	DS7242	\$1,191	+\$0	+\$63	+\$168	+\$294	+\$504	+\$714	+\$924
72" x 48"	DS7248	\$1,259	+\$0	+\$63	+\$168	+\$294	+\$504	+\$714	+\$924

Please reference the [Textile Reference Guide](#) for information on approved textiles for Motif products.

EFFECTIVE NOVEMBER 4, 2024 | GSA SIN #: 33721

4. Base

Base Design	Code	Price	
-------------	------	-------	--

T-Shaped Foot

SF4

+ \$0



Triangular-Shaped Foot

SF5

+ \$0



Base Finish	Code	Price	
-------------	------	-------	--

Silver

BF01

+ \$0

White

BF02

+ \$0

Black

BF03

+ \$0

Mobility Options	Code	Price	
------------------	------	-------	--

Glides

LS18

+ \$0

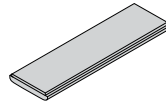

Carpet Casters

LS19

+ \$180

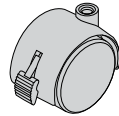

SPECIFICATIONS

Model:	3092 Motif Mobile/Freestanding Screen
---------------	--

Screen Thickness

1"

Foot Height

0.63" (SF4+LS18), 3.25" (SF5+LS18)
2.75" (SF4+LS19), 5.5" (SF5+LS19)

Foot Length

16.38"

Foot Width

1.5"

Floor to Bottom of Screen

2.63" (LS18)
4.75" (SF4+LS19)
4.88" (SF5+LS19)

Glides (LS18). Casters (LS19). T-shaped foot (SF4). Triangular-shaped foot (SF5).



Freestanding

Motif

MODESTY SCREEN

Versatile peace of mind.

Fashion spaces that are as focused on privacy as they are on design. Our collection of fabric modesty screens come in a variety of color and size options, letting you create environments that are perfectly cohesive and coordinated.



10" x 60" Modesty Screen
Table not included; see [page 457](#) for Parallon Fixed-Top.

EFFECTIVE NOVEMBER 4, 2024

Featured Models

48" :: \$415

Modesty Screen, 10" x 48",
grade 1 fabric,

60" :: \$491

Modesty Screen, 10" x 60",
grade 1 fabric,

72" :: \$593

Modesty Screen, 10" x 72",
grade 1 fabric,

Features

- Get customized privacy with durable fabrics designed to heal from pins, thumbtacks and more
- Find privacy + protection with fabrics that are bleach-cleanable, helping protect against COVID-19
- Eco-friendly, single-piece construction features a HexaCore honeycomb center, providing rigidity with less weight
- Width options range from 25" – 72"
- Hinged mount attaches onto edge of bench or table

1. Product

Product Type	Code	Price
Modesty Screen	3093	Priced by Size

2. Material

Material Type	Code	Price
Fabric/Vinyl	DT701	Priced by Grade and Size

Material Grade	Code	Price
Fabric/Vinyl Grade 1	FG1/VG1	Priced by Size
Fabric/Vinyl Grade 2	FG2/VG2	Priced by Size
Fabric/Vinyl Grade 3	FG3/VG3	Priced by Size
Fabric/Vinyl Grade 4	FG4/VG4	Priced by Size
Fabric/Vinyl Grade 5	FG5/VG5	Priced by Size
Fabric/Vinyl Grade 6	FG6/VG6	Priced by Size
Fabric/Vinyl Grade 7	FG7/VG7	Priced by Size

3. Size

Screen Size	Code	Price							
For Rectangular Tabletops	Base Price	Grade 1	Grade 2	Grade 3	Grade 4	Grade 5	Grade 6	Grade 7	
10" x 25"	DS1025	\$415	+\$17	+\$45	+\$79	+\$136	+\$193	+\$250	
10" x 31"	DS1031	\$491	+\$21	+\$56	+\$98	+\$168	+\$238	+\$308	
For Rectangular Tabletops	Base Price	Grade 1	Grade 2	Grade 3	Grade 4	Grade 5	Grade 6	Grade 7	
10" x 36"	DS1036	\$337	+\$10	+\$31	+\$55	+\$95	+\$134	+\$173	
10" x 40"	DS1040	\$374	+\$15	+\$40	+\$70	+\$120	+\$170	+\$220	
10" x 42"	DS1042	\$374	+\$15	+\$40	+\$70	+\$120	+\$170	+\$220	
10" x 46"	DS1046	\$415	+\$17	+\$45	+\$79	+\$136	+\$193	+\$250	
10" x 48"	DS1048	\$415	+\$17	+\$45	+\$79	+\$136	+\$193	+\$250	
10" x 52"	DS1052	\$454	+\$19	+\$50	+\$88	+\$152	+\$215	+\$278	
10" x 54"	DS1054	\$454	+\$19	+\$50	+\$88	+\$152	+\$215	+\$278	
10" x 58"	DS1058	\$491	+\$21	+\$56	+\$98	+\$168	+\$238	+\$308	
10" x 60"	DS1060	\$491	+\$21	+\$56	+\$98	+\$168	+\$238	+\$308	
10" x 64"	DS1064	\$531	+\$23	+\$61	+\$107	+\$184	+\$261	+\$338	
10" x 66"	DS1066	\$531	+\$23	+\$61	+\$107	+\$184	+\$261	+\$338	
10" x 70"	DS1070	\$593	+\$25	+\$66	+\$116	+\$200	+\$283	+\$366	
10" x 72"	DS1072	\$593	+\$25	+\$66	+\$116	+\$200	+\$283	+\$366	

Please reference the [Textile Reference Guide](#) for information on approved textiles for Motif products.

4. Mount

Mount Style	Code	Price
Modesty Screen Mount Compatibility: 25"-72" Screen Width 10" Screen Height	MT8	+\$0

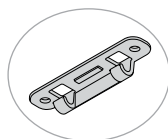

Modesty screens include the cost of the mount.

Sector

ACRYLIC WORKSURFACE SCREEN

Partition and protect.

Now more than ever, our workspaces should be safe—free from distractions, contagions and anything that gets in the way of productivity. This collection of clear and frosted acrylic screens stands ready to provide the privacy, protection and peace of mind you need in a landscape where the way we interact changes every day.



30" x 48" Height-adjustable Frosted Acrylic Screen
Table not included; see [page 480](#) for Switchback 2-Leg.

EFFECTIVE NOVEMBER 4, 2024

Featured Models

12" x 23" EDGE :: \$215

12" x 23" frosted acrylic screen,
edge mount

30" x 48" HA :: \$649

30" x 48" frosted acrylic screen,
height-adjustable mount

30" x 60" MIDWAY :: \$787

30" x 60" clear acrylic screen,
midway mount

Features

- Frosted acrylic provides essential privacy while clear acrylic allows for safe social interactions
- High-performing, resilient acrylic surfaces can withstand some of the most powerful cleaners and disinfectants, including a full range of EPA-approved COVID-19 products
- Lightweight material offers greater resistance to impact compared to glass alternatives
- Height options include 12, 18, and 24 inches; 30 inches available for midway and height-adjustable table mounts
- Width options range from 17 to 72 inches (in six-inch increments)
- Compatible with most mounts, including edge, middle, top, midway, freestanding, panel and height-adjustable

1. Product

Product Type	Code	Price
Screen	3090	Priced by Size

2. Material

Material Type	Code	Price
Clear Acrylic	DT101C	Priced by Size
Frosted Acrylic	DT101	Priced by Size

3. Size

Screen Size (H x W)	Code	Price
12" High Screens		
12" x 17"	DS1217	\$94
12" x 18"	DS1218	\$94
12" x 21"	DS1221	\$127
12" x 22"	DS1222	\$127
12" x 23"	DS1223	\$127
12" x 24"	DS1224	\$127
12" x 27"	DS1227	\$159
12" x 28"	DS1228	\$159
12" x 29"	DS1229	\$159
12" x 30"	DS1230	\$159
12" x 36"	DS1236	\$195

3. Size (Cont.)

Screen Size (H x W)	Code	Price
12" High Screens (Cont.)		
12" x 40"	DS1240	\$226
12" x 42"	DS1242	\$226
12" x 46"	DS1246	\$258
12" x 48"	DS1248	\$258
12" x 52"	DS1252	\$292
12" x 54"	DS1254	\$292
12" x 58"	DS1258	\$323
12" x 60"	DS1260	\$323
12" x 64"	DS1264	\$355
12" x 66"	DS1266	\$355
12" x 70"	DS1270	\$387
12" x 72"	DS1272	\$387
18" High Screen		
18" x 17"	DS1817	\$128
18" x 18"	DS1818	\$128
18" x 21"	DS1821	\$190
18" x 22"	DS1822	\$190
18" x 23"	DS1823	\$190
18" x 24"	DS1824	\$190
18" x 27"	DS1827	\$237
18" x 28"	DS1828	\$237
18" x 29"	DS1829	\$237
18" x 30"	DS1830	\$237
18" x 36"	DS1836	\$292
18" x 40"	DS1840	\$341
18" x 42"	DS1842	\$341
18" x 46"	DS1846	\$387
18" x 48"	DS1848	\$387
18" x 52"	DS1852	\$434
18" x 54"	DS1854	\$434
18" x 58"	DS1858	\$483
18" x 60"	DS1860	\$483
18" x 64"	DS1864	\$485
18" x 66"	DS1866	\$485
18" x 70"	DS1870	\$527
18" x 72"	DS1872	\$527

EFFECTIVE NOVEMBER 4, 2024 | GSA SIN #: 33721





3. Size (Cont.)

Screen Size (H x W)	Code	Price
24" High Screen		
24" x 17"	DS2417	\$168
24" x 18"	DS2418	\$168
24" x 21"	DS2421	\$226
24" x 22"	DS2422	\$226
24" x 23"	DS2423	\$226
24" x 24"	DS2424	\$226
24" x 27"	DS2427	\$287
24" x 28"	DS2428	\$287
24" x 29"	DS2429	\$287
24" x 30"	DS2430	\$287
24" x 36"	DS2436	\$354
24" x 40"	DS2440	\$412
24" x 42"	DS2442	\$412
24" x 46"	DS2446	\$456
24" x 48"	DS2448	\$456
24" x 52"	DS2452	\$528
24" x 54"	DS2454	\$528
24" x 58"	DS2458	\$569
24" x 60"	DS2460	\$569
24" x 64"	DS2464	\$625
24" x 66"	DS2466	\$625
24" x 70"	DS2470	\$683
24" x 72"	DS2472	\$683
30" High Screen		
30" x 24"	DS3024	\$287
30" x 30"	DS3030	\$358
30" x 36"	DS3036	\$427
30" x 40"	DS3040	\$498
30" x 42"	DS3042	\$498
30" x 46"	DS3046	\$569
30" x 48"	DS3048	\$569
30" x 52"	DS3052	\$640
30" x 54"	DS3054	\$640
30" x 58"	DS3058	\$711
30" x 60"	DS3060	\$711
30" x 64"	DS3064	\$781
30" x 66"	DS3066	\$781
30" x 70"	DS3070	\$851
30" x 72"	DS3072	\$851

3. Size (Cont.)

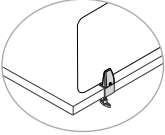
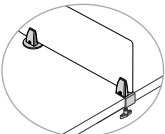
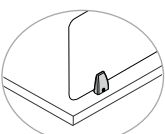
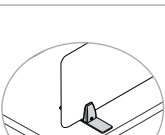

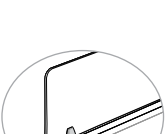
Screen Size (H x W)	Code	Price
36" High Screen		
36" x 24"	DS3624	\$354
36" x 30"	DS3630	\$427
36" x 36"	DS3636	\$502
36" x 40"	DS3640	\$577
36" x 42"	DS3642	\$577
36" x 46"	DS3646	\$652
36" x 48"	DS3648	\$652
36" x 52"	DS3652	\$727
36" x 54"	DS3654	\$727
36" x 58"	DS3658	\$802
36" x 60"	DS3660	\$802
36" x 64"	DS3664	\$877
36" x 66"	DS3666	\$877
36" x 70"	DS3670	\$952
36" x 72"	DS3672	\$952

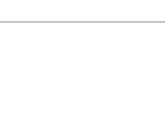
4. Mount

Mount Style	Code	Price	
Protective/Privacy			
Edge Mount Compatibility: 17"-54" Screen Width 12"-24" Screen Height	MT1	+ \$88	
Edge Mount Compatibility: 60"-72" Screen Width 12"-24" Screen Height	MT1	+ \$132	
Middle Mount Compatibility: 17"-29" Screen Width 12"-24" Screen Height	MT2	+ \$88	
Top Mount Compatibility: 17"-54" Screen Width 12"-24" Screen Height	MT3	+ \$56	
Top Mount Compatibility: 60"-72" Screen Width 12"-24" Screen Height	MT3	+ \$84	
Freestanding Mount Compatibility: 17"-54" Screen Width 12"-24" Screen Height	MT4	+ \$88	
Freestanding Mount Compatibility: 60"-72" Screen Width 12"-24" Screen Height	MT4	+ \$132	
Small Panel Mount Compatibility: 1.5"-2.3" Panel Depth 17"-54" Screen Width 12"-24" Screen Height	MT9	+ \$88	
Small Panel Mount Compatibility: 1.5"-2.3" Panel Depth 60"-72" Screen Width 12"-24" Screen Height	MT9	+ \$132	
Large Panel Mount Compatibility: 2.3"-3.7" Panel Depth 17"-54" Screen Width 12"-24" Screen Height	MT10	+ \$88	
Large Panel Mount Compatibility: 2.3"-3.7" Panel Depth 60"-72" Screen Width 12"-24" Screen Height	MT10	+ \$132	

ACRYLIC WORKSURFACE SCREEN

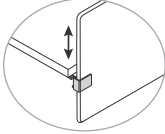
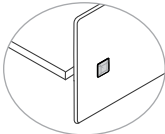
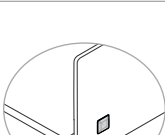
4. Mount (Cont.)

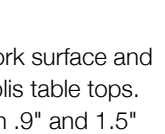
Mount Style	Code	Price	
Protective/Privacy + Modesty			
Height-Adjustable Mount Compatibility: 24"-60" Screen Width 18"-36" Screen Height	MT6	+ \$80	
Midway Mount Compatibility: 24"-54" Screen Width 24"-36" Screen Height	MT5	+ \$38	
Midway Mount Compatibility: 58"-72" Screen Width 24"-36" Screen Height	MT5	+ \$76	
Midway Mount – High Compatibility: 24"-54" Screen Width 18"-30" Screen Height	MT5H	+ \$38	
Midway Mount – High Compatibility: 24" - 72" Screen Width 18" - 30" Screen Height	MT5H	+ \$76	

NOTE:

Edge Mounts and Middle Mounts clamp to the work surface and are designed to be used with the standard Exemplis table tops. They will function, as designed, with tops between .9" and 1.5" thick. If the worksurface is less than .9" thick the customer will be responsible to add a spacer to bring the thickness into the allowable range

Sector

MOBILE + FREESTANDING ACRYLIC SCREEN

Adaptable peace of mind.

Now more than ever, our welcoming spaces should be safe—free from contagions, concern and anything that gets in the way of productivity. This collection of mobile and freestanding screens provides the protection and peace of mind you need to work with confidence.



EFFECTIVE NOVEMBER 4, 2024

Featured Models

FREESTANDING :: \$1,069

Freestanding screen with glides, 60" x 36", frosted acrylic

MOBILE :: \$1,249

Mobile screen with casters, 60" x 36", clear acrylic

LARGE MOBILE :: \$1,451

Mobile screen with casters, 72" x 48", clear acrylic

Features

- Mobile and freestanding screens are an easy-to-deploy solution for environments always in motion
- Quick installation creates safer spaces in minutes
- High-performing, resilient acrylic can withstand some of the most powerful cleaners and disinfectants, including a full range of EPA-approved COVID-19 products
- Frosted acrylic provides privacy while clear acrylic offers unimpeded protection
- Lightweight material offers greater resistance to impact compared to glass alternatives
- Foot styles include freestanding with glides or mobile with casters
- Silver frame finish

SPECIFICATIONS

	3092 Sector Freestanding/Mobile Screen
Screen Thickness	0.75"
Foot Height	0.63" (LS18), 2.63" (LS19)
Foot Length	16.38"
Foot Width	1"
Floor to Bottom of Screen	2.63" (LS18), 4.63" (LS19)

Glides (LS18). Casters (LS19)

MOBILE + FREESTANDING SCREEN

1. Product

Product Type	Code	Price
Freestanding/Mobile Screen	3092	Priced by Size

2. Material

Material Type	Code	Price
Frosted Acrylic	DT101	Priced by Size
Clear Acrylic	DT101C	Priced by Size

3. Size

Screen Size	Code	Price
53" x 30"	DS5330	\$805
53" x 36"	DS5336	\$879
53" x 42"	DS5342	\$955
53" x 48"	DS5348	\$1,028
60" x 30"	DS6030	\$980
60" x 36"	DS6036	\$1,069
60" x 42"	DS6042	\$1,159
60" x 48"	DS6048	\$1,249
72" x 30"	DS7230	\$1,069
72" x 36"	DS7236	\$1,129
72" x 42"	DS7242	\$1,261
72" x 48"	DS7248	\$1,271

4. Base

Base Finish	Code	Price
Silver	BF01	+ \$0
White	BF02	+ \$0
Black	BF03	+ \$0



Mobility Options	Code	Price
Glides	LS18	+ \$0
Carpet Casters	LS19	+ \$180

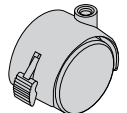
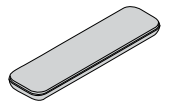

Sector

ACRYLIC SEATING SCREEN

Partition and protect.

Now more than ever, our welcoming spaces should be safe—free from contagions, concern and anything that gets in the way of interacting. This collection of seating screens provides the privacy, protection and peace of mind you need to wait with confidence.



Freelance

EFFECTIVE NOVEMBER 4, 2024

Featured Models

AVIERA :: \$542

47" x 24" seating screen compatible with Aviera Guest, Aviera Patient, Aviera Freespan and Aviera Preconfigured models

FOCUS SIDE :: \$542

47" x 24" seating screen compatible with Focus Side chairs. Not compatible with stools or casters

FREELANCE :: \$542



47" x 24" seating screen compatible with Freelance and Freelance Bariatric chair models. Not compatible with stools or casters

Features

- Compatible with Aviera, Freelance and Focus Side
- Seating screens provide fixed, consistent distancing between each chair for safer spaces
- Patent-pending interlocking mount easily transforms current seating configurations while creating more efficient floor plans
- High-performing, resilient acrylic surfaces can withstand some of the most powerful cleaners and disinfectants, including a full range of EPA approved COVID-19 products
- Frosted acrylic provides privacy while clear acrylic allows for safe interactions
- Quick to ship and easy to integrate
- Silver and black bracket finishes

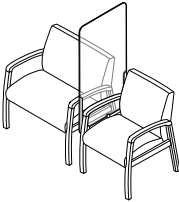

1. Product

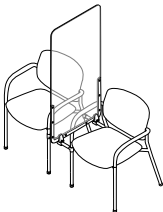
Model	Code	Price	
Screens for Aviera	3097 VRX	\$542	
Screens for Focus Side	3097 56X	\$542	
Screens for Freelance	3097 52X	\$542	

2. Material

Material Type	Code	Price	
Clear Acrylic	DT101C	+ \$0	
Frosted Acrylic	DT101	+ \$0	

ACRYLIC SEATING SCREEN

3. Size

Screen Size	Code	Price
47" x 24"	DS4724	+ \$0

4. Finish

Bracket Finish	Code	Price
Black	BKF03	+ \$0
Silver	BKF01	+ \$0

5. Replacements

Parts	Code	Price
Screen	Frame and Screen	\$332
Interlocking Bracket Kit For Focus Side	Complete Bracket	\$210
Interlocking Bracket Kit For Freelance	Complete Bracket	\$210
Interlocking Bracket Kit For Aviera	Complete Bracket	\$210

SPECIFICATIONS

Model:	3097 VRX Seating Screen for Aviera	3097 56X Seating Screen for Focus Side	3097 52X Seating Screen for Freelance
Screen Size	46.5" x 23.5"	46.5" x 23.5"	46.5" x 23.5"
Chair Gap (A) Armless	—	9.5"	10"
Chair Gap (A) With Arms	5.3"	5.7"	6"
From Chair to Screen (B) Armless	—	4.5"	4.75"
From Chair to Screen (B) With Arms	2.4"	2.6"	2.75"
Height to Base of Interlocking Assembly (C)	12.4"	11.3"	11.3"
Height From Floor to Top of Screen (D)	60"	60"	60"
Two Guest Chairs With Screen (E)	54.3"	54.7"	57"
Three Guest Chairs With Screens (F)	84.1"	84.9"	88.5"
Four Guest Chairs With Screens (G)	113.9"	115.1"	120"
Screen Thickness	0.75"	0.75"	0.75"

See the diagram below for assistance with measurements.

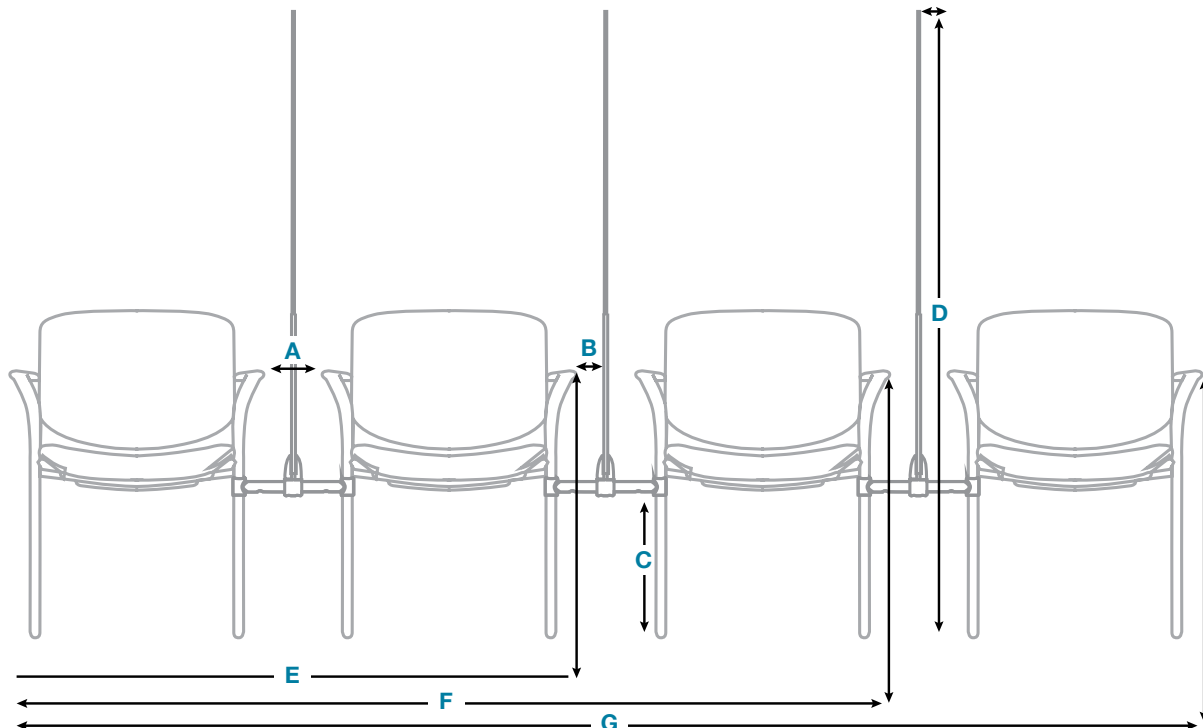

Sector

ACRYLIC CAFÉ SCREEN

Partition and protect.

Partition and protect. Now more than ever, our shared spaces should be safe—free from contagions, concerns and anything that gets in the way of interacting. This collection of acrylic tabletop screens provides the protection and peace of mind you need to socialize with confidence.



EFFECTIVE NOVEMBER 4, 2024

Featured Models

2-PERSON :: \$412

2-person screen for 30" round table,
30" screen height

4-PERSON :: \$1,221

4-person screen for 48" square table,
30" screen height

Features

- Clear acrylic allows for safe social interactions
- High-performing, resilient acrylic surfaces can withstand some of the most powerful cleaners and disinfectants, including a full range of EPA-approved COVID-19 products
- Lightweight material offers greater resistance to impact compared to glass alternatives
- 2-Person café table is available with three different foot styles

1. Product

Product Type	Code	Price
Tabletop Screen	3096	Priced by Size

Screen Type	Code	Price
Café Round	CRSC	Priced by Size
Café Square	CSSC	Priced by Size

2. Material

Material Type	Code	Price
Clear Acrylic	DT101C	Priced by Size

3. Size

Screen Height	Code	Price
Screen Height, 24"	SCH24	Priced by Table Size
Screen Height, 30"	SCH30	Priced by Table Size

Table Size	Code	Price
2-Person Café Screen		
		24" Height 30" Height
24" Round	TR2424	\$294 \$353
30" Round	TR3030	\$345 \$412
24" Square	TS2424	\$294 \$353
30" Square	TS3030	\$345 \$412
4-Person Café Screen		
		24" Height 30" Height
36" Round	TR3636	\$486 \$578
42" Round	TR4242	\$537 \$628
48" Round	TR4848	\$584 \$641
36" Square	TS3636	\$828 \$1,100
42" Square	TS4242	\$911 \$1,160
48" Square	TS4848	\$1,001 \$1,221

ACRYLIC CAFÉ SCREEN

4. Feet (2-Person Only)

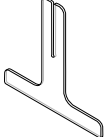
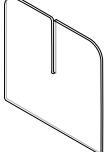
Foot Style	Code	Price	
Round-Shaped	SF1	+ \$0	
T-Shaped	SF2	+ \$0	
Square-Shaped	SF3	+ \$0	

Sector

ACRYLIC TRANSACTION SCREEN

Partition and protect.

Partition and protect. Now more than ever, our shared spaces should be safe—free from contagions, concerns and anything that gets in the way of interacting. This collection of acrylic tabletop screens provides the protection and peace of mind you need to interact with confidence.



EFFECTIVE NOVEMBER 4, 2024

Featured Models

PASS-THROUGH :: \$400

24" x 36" acrylic screen, pass-through, round feet

NO PASS-THROUGH :: \$400

24" x 36" acrylic screen, no pass-through, round feet

Features

- 1-on-1 transaction screens sit ready to protect during quick interactions and small get togethers
- Quick and easy tabletop installation means you can provide protection in seconds
- Clear acrylic allows for safe social interactions
- High-performing, resilient acrylic surfaces can withstand some of the most powerful cleaners and disinfectants, including a full range of EPA-approved COVID-19 products.
- Lightweight material offers greater resistance to impact compared to glass alternatives.
- Available with three different foot styles
- Optional 4" tall pass-through

1. Product

Product Type	Code	Price	
Tabletop Screen	3096	Priced by Size	
Screen Type	Code	Price	
Transaction	TRSC	Priced by Size	

2. Material

Material Type	Code	Price	
Clear Acrylic	DT101C	Priced by Size	

3. Size

Size (H x W)	Code	Price	
24" Width			
24" x 24"	SCH24 SCW24	\$294	
30" x 24"	SCH30 SCW24	\$353	
36" x 24"	SCH36 SCW24	\$405	
42" x 24"	SCH42 SCW24	\$433	
30" Width			
24" x 30"	SCH24 SCW30	\$345	
30" x 30"	SCH30 SCW30	\$412	
36" x 30"	SCH36 SCW30	\$442	
42" x 30"	SCH42 SCW30	\$506	

ACRYLIC TRANSACTION SCREEN

3. Size (Cont.)

Size (H x W) (Cont.)	Code	Price	
36" Width			
24" x 36"	SCH24 SCW36	\$400	
30" x 36"	SCH30 SCW36	\$425	
36" x 36"	SCH36 SCW36	\$467	
42" x 36"	SCH42 SCW36	\$545	
48" Width			
24" x 48"	SCH24 SCW48	\$442	
30" x 48"	SCH30 SCW48	\$464	
36" x 48"	SCH36 SCW48	\$486	
42" x 48"	SCH42 SCW48	\$589	

4. Appearance

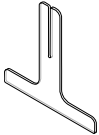
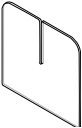
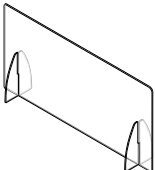
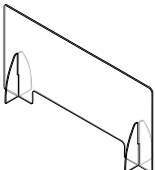
Foot Style	Code	Price	
Round-Shaped	SF1	+ \$0	
T-Shaped	SF2	+ \$0	
Square-Shaped	SF3	+ \$0	
Pass-Through	Code	Price	
No Pass-Through	NPT	+ \$0	
Pass-Through	PTI	+ \$0	

Sector

TRI-FOLD ACRYLIC MEETING AND SINGLE-TABLE SCREEN

Partition and protect.

Partition and protect. Now more than ever, our shared spaces should be safe—free from contagions, concerns and anything that gets in the way of interacting. This collection of acrylic tabletop screens provides the protection and peace of mind you need to meet with confidence.



EFFECTIVE NOVEMBER 4, 2024

Featured Models

SINGLE TABLE :: \$604

24" x 48" tri-fold acrylic single-table screen, 24" height

MEETING :: \$1,307

20" x 58" tri-fold acrylic meeting screen, 30" height

Features

- From individual desks to large board rooms, tri-fold meeting screens are personal, mobile and adapt to the busy classroom or office easily
- Single-table tri-fold screens conveniently match common tabletop sizes; tri-fold meeting screens allow you to subdivide larger meeting tables
- High-performing, resilient acrylic surfaces can withstand some of the most powerful cleaners and disinfectants, including a full range of EPA-approved COVID-19 products
- Clear acrylic allows for safe social interactions
- Lightweight material offers greater resistance to impact compared to glass alternatives

1. Product

Product Type	Code	Price
Tabletop Screen	3096	Priced by Size
Product Style	Code	Price

Tri-Fold Screen

TFSC

Priced by Size

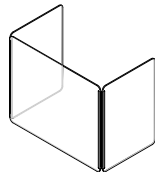

2. Material

Material	Code	Price
Clear Acrylic	DT101C	Priced by Size

TRI-FOLD ACRYLIC MEETING AND SINGLE-TABLE SCREEN

3. Size

Table Size (D x W)	Code	Price
Tri-Fold Single-Table, 24" Height		
18" x 48"	SCH24 SCW46 SCD17	\$482
18" x 60"	SCH24 SCW58 SCD17	\$801
24" x 48"	SCH24 SCW46 SCD23	\$604
24" x 60"	SCH24 SCW58 SCD23	\$923
30" x 48"	SCH24 SCW46 SCD29	\$676
30" x 60"	SCH24 SCW58 SCD29	\$1,016
Tri-Fold Single-Table, 30" Height		
18" x 48"	SCH30 SCW46 SCD17	\$793
18" x 60"	SCH30 SCW58 SCD17	\$1,166
24" x 48"	SCH30 SCW46 SCD23	\$997
24" x 60"	SCH30 SCW58 SCD23	\$1,462
30" x 48"	SCH30 SCW46 SCD29	\$1,019
30" x 60"	SCH30 SCW58 SCD29	\$1,638
Tri-Fold Meeting, 24" Height		
17" x 29"	SCH24 SCW29 SCD17	\$456
17" x 46"	SCH24 SCW46 SCD17	\$482
17" x 58"	SCH24 SCW58 SCD17	\$801
20" x 29"	SCH24 SCW29 SCD20	\$471
20" x 46"	SCH24 SCW46 SCD20	\$541
20" x 58"	SCH24 SCW58 SCD20	\$879
23" x 29"	SCH24 SCW29 SCD23	\$488
23" x 46"	SCH24 SCW46 SCD23	\$604
23" x 58"	SCH24 SCW58 SCD23	\$923
29" x 29"	SCH24 SCW29 SCD29	\$507
Tri-Fold Meeting, 30" Height		
17" x 29"	SCH30 SCW29 SCD17	\$683
17" x 46"	SCH30 SCW46 SCD17	\$793
17" x 58"	SCH30 SCW58 SCD17	\$1,166
20" x 29"	SCH30 SCW29 SCD20	\$763
20" x 46"	SCH30 SCW46 SCD20	\$929
20" x 58"	SCH30 SCW58 SCD20	\$1,307
23" x 29"	SCH30 SCW29 SCD23	\$855
29" x 29"	SCH30 SCW29 SCD29	\$916

On single-table tri-fold screens, the screen depth is 1" less than the table's depth and 2" shorter than the table width.

For instance: A 24" x 48" tabletop has a screen with an actual size of 23" x 46".

EFFECTIVE NOVEMBER 4, 2024 | GSA SIN #: 33721

MEETING TABLE COMPATIBILITY CHART

Screen Size (D x W)	Code	Seats Supported
36" x 72" Conference Table		
17" x 29"	SCH24 SCW29 SCD17	2 Seats Per Side
17" x 46"	SCH24 SCW46 SCD17	1 Seat Per Side
17" x 58"	SCH24 SCW58 SCD17	1 Seat Per Side
42" x 84" Conference Table		
20" x 29"	SCH24 SCW29 SCD20	2 Seats Per Side
20" x 46"	SCH24 SCW46 SCD20	1 Seat Per Side
20" x 58"	SCH24 SCW58 SCD20	1 Seat Per Side
48" x 96" Conference Table		
23" x 29"	SCH24 SCW29 SCD23	3 Seats Per Side
23" x 46"	SCH24 SCW46 SCD23	2 Seats Per Side
23" x 58"	SCH24 SCW58 SCD23	1 Seat Per Side
29" x 29"	SCH24 SCW29 SCD29	1 Seat Per Side

Sector

ACRYLIC MODESTY SCREEN



*Frosted Acrylic Modesty Screen
Table not included. See [page 449](#) for Ocala.
Chair not included. See [page 192](#) for Wit.*

EFFECTIVE NOVEMBER 4, 2024

Featured Models

48" :: \$355

Modesty Screen, 10" x 48", grade 1 fabric,

60" :: \$420

Modesty Screen, 10" x 60", grade 1 fabric,

72" :: \$507

Modesty Screen, 10" x 72", grade 1 fabric,

Features

- Extra privacy for users
- Hinged mount attaches onto edge of bench or table
- Screens can be built from frosted acrylic or laminate
- Screens are 10" high and available in widths ranging from 25" to 72"
- Acrylic panels are 0.24" thick;

1. Product

Product Type	Code	Price
Modesty Screen	3093	Priced by Size

2. Material

Material Type	Code	Price
Frosted Acrylic	DT101	Priced by Size

3. Size

Screen Size (H x W)	Code	Price
For Rectangular Tables		
10" x 36"	DS1036	\$288
10" x 40"	DS1040	\$320
10" x 42"	DS1042	\$320
10" x 46"	DS1046	\$355
10" x 48"	DS1048	\$355
10" x 52"	DS1052	\$388
10" x 54"	DS1054	\$388
10" x 58"	DS1058	\$420
10" x 60"	DS1060	\$420
10" x 64"	DS1064	\$454
10" x 66"	DS1066	\$454
10" x 70"	DS1070	\$507
10" x 72"	DS1072	\$507
For Trapezoid Tables		
10" x 25"	DS1025	\$355
10" x 31"	DS1031	\$420

4. Mount

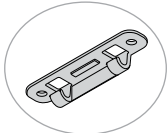
Mount Style	Code	Price	
Modesty Screen Mount Compatibility: 25"-72" Screen Width 10" Screen Height	MT8	+\$0	

Modesty screens include the cost of the mount.

Monitor Arms

SINGLE POLE | DUAL POLE |
TRIPLE POLE SINGLE DESK | DUAL DESK
HEAVY DUTY | DUAL ARRAY

Statement of Line

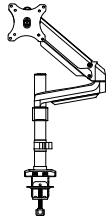

Mobio

Single Pole Monitor Arm
3210 MAT30..... [Page 598](#)

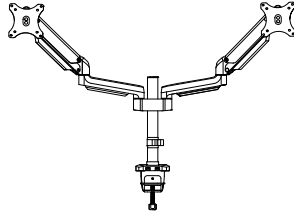

Mobio

Dual Pole Monitor Arm
3210 MAT31..... [Page 598](#)

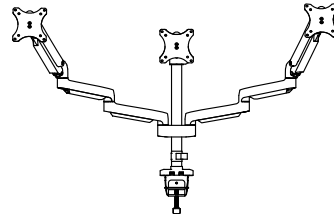

Mobio

Triple Pole Monitor Arm
3210 MAT32..... [Page 598](#)

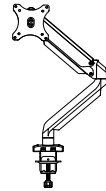

Mobio

Single Desk Monitor Arm
3210 MAT33..... [Page 598](#)

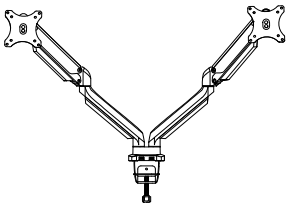

Mobio

Dual Desk Monitor Arm
3210 MAT34..... [Page 598](#)

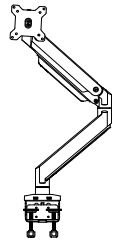

Mobio

Heavy Duty Single Desk Monitor Arm
3210 MAT35..... [Page 598](#)

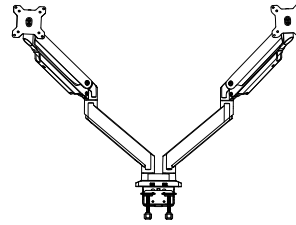

Mobio

Heavy Duty Dual Desk Monitor Arm
3210 MAT36..... [Page 598](#)

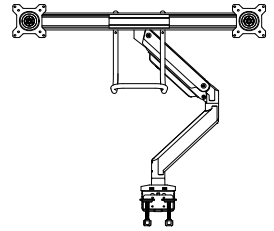

Mobio

Heavy Duty Dual Array Monitor Arm
3210 MAT37..... [Page 598](#)

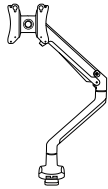

Unity G2

Single
3111 MAT06..... [Page 602](#)

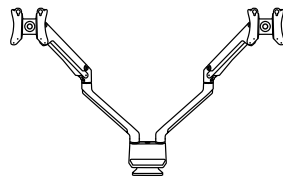

Unity G2

Dual
3111 MAT07..... [Page 602](#)

Mobio

MONITOR ARM

Experience unmatched performance.

When you're hard at work, you need a workspace that works hard for you. With a wide range of motion and ultra-reliability, Mobio is your go-to solution for a family of monitor arms to maximize your space. Its compact design and die cast aluminum construction mean greater stability, flexibility and unmatched performance.



Featured Models

POWER READY :: \$477

Mobio single desk monitor arm with power block accessory

DUAL DESK :: \$605

Mobio dual desk monitor arm

DUAL ARRAY HD :: \$702

Mobio heavy duty dual array monitor arm

Features

- Choose from Mobio arms in single-desk, dual-desk and pole-mount configurations
- Choose from Mobio HD arms in single-desk, dual-desk and dual-array configurations
- Compact aluminum arm design maximizes desktop space
- Die-cast aluminum construction ensures stability and performance
- Gas spring mechanism delivers smooth vertical adjustment
- Built-in spring tension gauge enables perfect weight adjustment
- Provide power to any worksurface with optional add-on power modules or passthrough USB cables
- Tool-less monitor sliders attach quickly and give an extra dimension of adjustability
- Includes surface clamp and grommet mount, ideal for all desk mounting configurations
- Power-ready and HD dual array models feature 180-degree rotation lock to keep all arms (and elbows) from bumping into walls
- Install monitors easily with quick-release VESA plate
- Mobio arms support monitors 17" to 32" (3.3 lb–17.6 lb); Mobio HD arms support monitors 17"–35" inches (2.2 lb–33 lb)

MONITOR ARM

1. Product

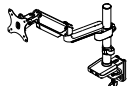
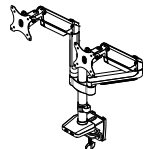
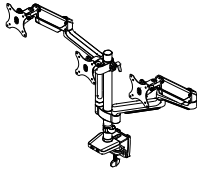
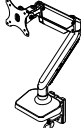
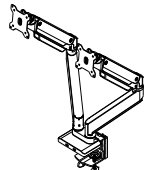
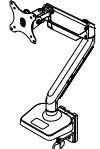
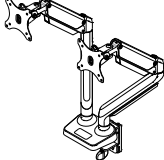
Product Style	Code	Price	
Mobio			
Single Pole Monitor Arm	3210 MAT30	\$387	
Dual Pole Monitor Arm	3210 MAT31	\$696	
Triple Pole Monitor Arm	3210 MAT32	\$807	
Single Desk Monitor Arm	3210 MAT33	\$303	
Dual Desk Monitor Arm	3210 MAT34	\$605	
Single Desk Monitor Arm, Power Ready	3210 MAT38	\$303	
Dual Desk Monitor Arm, Power Ready	3210 MAT39	\$605	

1. Product (Cont.)

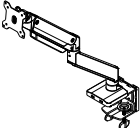
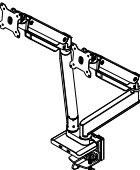
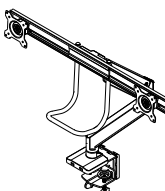
Product Style	Code	Price	
Mobio HD			
Heavy Duty Single Desk Monitor Arm	3210 MAT35	\$473	
Heavy Duty Dual Desk Monitor Arm	3210 MAT36	\$1,060	
Heavy Duty Dual Array Monitor Arm	3210 MAT37	\$702	



Power Ready
Table not included. See [page 480](#) for Switchback.

MONITOR ARM

2. Accessories

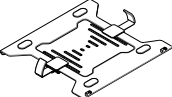
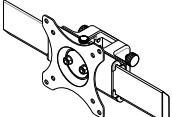
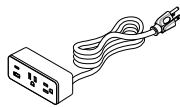
Laptop Support	Code	Price	
No Accessories	MAA00	+ \$0	
Laptop Tray	MAA03	+ \$99	
Monitor Sliders	Code	Price	
Single Slider	MAA01	+ \$120	
Dual Sliders	MAA02	+ \$239	
Power	Code	Price	
Power Block, AC/110V, USB-A, USB-C	MAA04	+ \$174	

Power block (MAA03) is available on independently (MAT00) or on power ready models (MAT38/MAT39) only.

3. Monitor Arm Finish

Paint Color	Code	Price	
Silver	MAC01	+ \$0	
Black	MAC03	+ \$0	

HD models are available in silver (MAC01) finish only.

SPECIFICATIONS: POLE ARMS

	MAT30 Single Pole	MAT31 Dual Pole	MAT32 Triple Pole
Max Monitor Size	17"-32"	17"-32"	17"-27"
Max Arm Extension (A)	23.16"	21.3"	28.58"
1st Arm Segment (B)	3.21"	3.21"	3.21"
2nd Arm Segment (C)	10.83"	10.83"	10.83"
3rd Arm Segment (D)	9.12"	7.27"	7.27"
Height Range (E)	3.54"–22.65"	3.54"–22.64"	6.10"–17.13"
Pole Height (F)	12.58"	12.58"	18.09"
Table Top Thickness	0.39"–2.17"	0.39"–2.17"	0.39"–2.17"
VESA	75 mm 100 mm	75 mm 100 mm	75 mm 100 mm
Weight Capacity (Per Screen)	3.3–17.6 lb	3.3–17.6 lb	3.3–17.6 lb

SPECIFICATIONS: DESK ARMS

	MAT33 Single Desk	MAT34 Dual Desk
Max Monitor Size	17"-32"	17"-32"
Max Arm Extension	20.72"	20.72"
1st Arm Segment (B)	3.21"	3.21"
2nd Arm Segment (C)	10.83"	10.83"
3rd Arm Segment (D)	6.68"	6.68"
Height Range (E)	5.31"–16.24"	5.31"–16.24"
Table Top Thickness	0.39"–2.17"	0.39"–2.17"
VESA	75 mm 100 mm	75 mm 100 mm
Weight Capacity (Per Screen)	3.3–17.6 lb	3.3–17.6 lb

SPECIFICATIONS: HEAVY DUTY ARMS

	MAT35 Single Desk HD	MAT36 Dual Desk	MAT37 Dual Array
Max Monitor Size	17"-35"	17"-35"	17"-32"
Max Extension (A)	23.49"	23.49"	12.68"
1st Arm Segment (B)	2.73"	2.73"	4.09"
2nd Arm Segment (C)	12.62"	12.62"	12.68"
3rd Arm Segment (D)	8.14"	8.14"	8.14"
Height Range	10.03"–23.03"	10.03"–23.03"	10.43"–23.43"
Table Top Thickness	0.39"–2.04"	0.39"–2.04"	0.39"–2.04"
VESA	75 mm 100 mm	75 mm 100 mm	75 mm 100 mm
Weight Capacity (Per Screen)	2.2–33 lb	2.2–33 lb	2.2 lb–17.6 lb

MONITOR ARM

FULLY EXTENDED POLE MODELS

(MAT30 | MAT31 | MAT32)

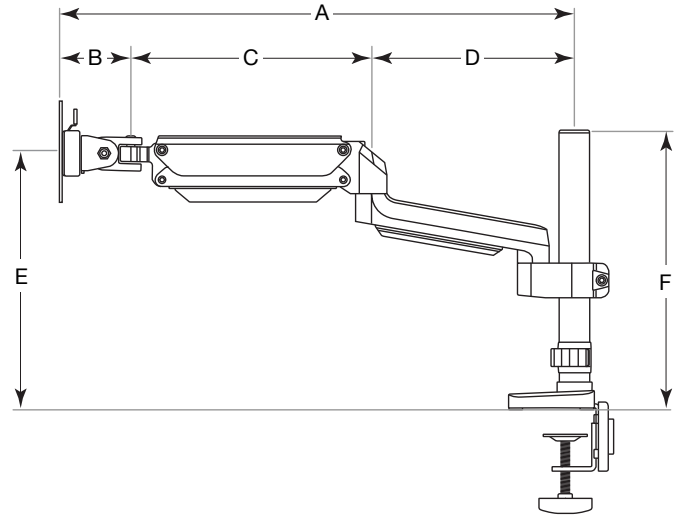

FULLY EXTENDED DESK AND HEAVY DUTY MODELS

(MAT33 | MAT34 | MAT35 | MAT36 | MAT37)

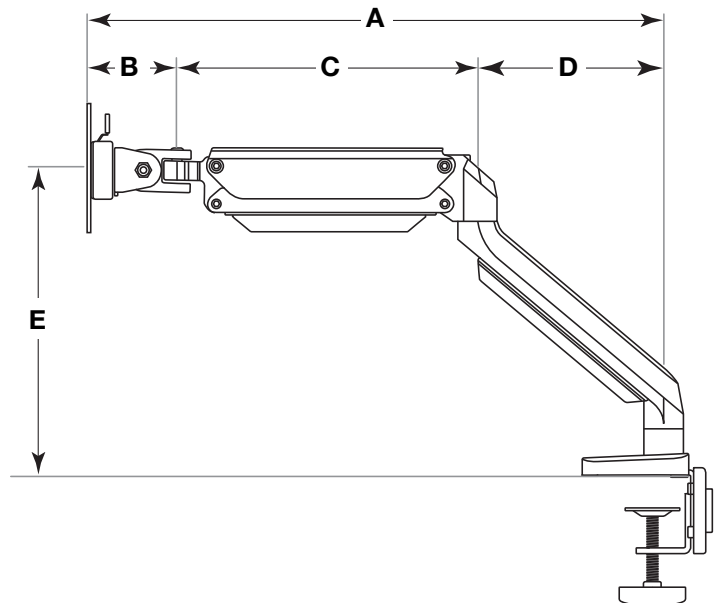

Unity G2

MONITOR ARM

Altogether powerful.

Be one with your work. Our Unity G2 family of monitor arms combine reliable utility with rugged design to create the perfect solution for any workspace.



Single Monitor Arm
Table not included. See [page 506](#) for Tensor.

EFFECTIVE NOVEMBER 4, 2024

Featured Models

SINGLE :: \$356

Unity G2 single monitor arm, white finish

DUAL :: \$707

Unity G2 dual monitor arm, silver finish

MONITOR ARM

Features

- Gas height-adjustable
- 12 inches of lift
- 180-degree pan and 360-degree rotation

1. Monitor Arms

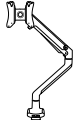
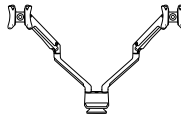
Product Type	Code	Price	
Single	3111 MAT06	\$356	
Dual	3111 MAT07	\$707	

2. Monitor Arm Finish

Paint Color	Code	Price
Silver	MAC01	+ \$0
White	MAC02	+ \$0

SPECIFICATIONS

	3111 MAT06 Single-Monitor	3111 MAT07 Dual-Monitor
Max Screen Size	N/A	17" – 29"
Max Extension	20.92"	20.92"
Height Range	6.9"–18.9"	7.6"–19.4"
VESA	75 mm, 100 mm	75 mm, 100 mm
Table Top Thickness	0.39"–1.5"	0.39"–1.5"
Weight Capacity (Per Arm)	4.4–17.6 lb	4.4–17.6 lb

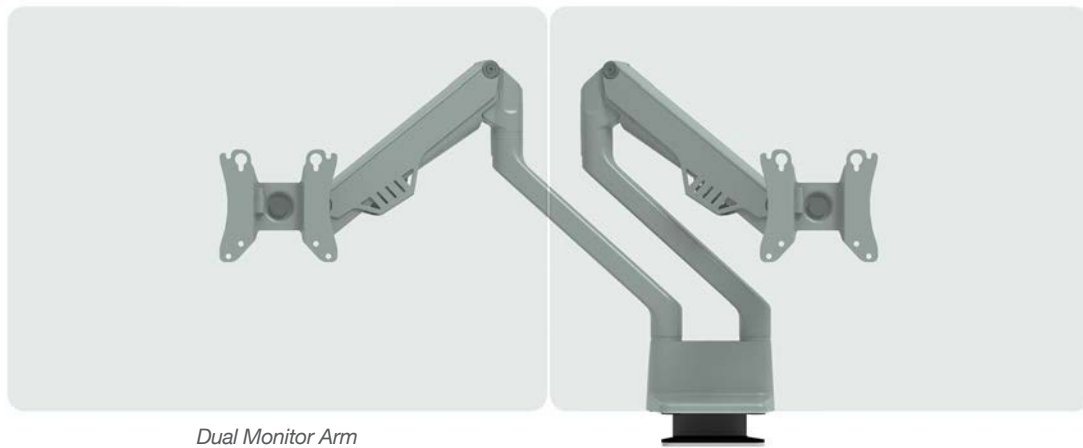

Accessories

STORAGE | POWER | LIGHTING
KEYBOARD TRAY | WIRE MANAGEMENT
DESKTOP SIT-TO-STAND
ANTI-FATIGUE MAT

Anti-Fatigue Mat

EFFECTIVE
NOVEMBER 4, 2024

Soft and supportive.

Promote well-being while ensuring productivity. Our anti-fatigue mat helps you stand (and work) longer—pairing well with our collections of height-adjustable tables and desktop workstations.

Anti-Fatigue Mat

Product	Code	Price
20" x 30" Black Anti-Fatigue Mat	3153 AFM01	\$214

Features and Specifications

- Provides premium ergonomic comfort
- Can reduce fatigue from standing up to 50%
- Durable single-piece construction
- 100% polyurethane integral skin design
- 20" (D) x 30" (W)
- 5-year warranty



Cable Caddy

WIRE MANAGEMENT

EFFECTIVE
NOVEMBER 4, 2024

GSA SIN #: 33721
3152 WM01, 3152 WM03, AND 3152 WM02 ONLY

Clear the cable clutter.

Features

CABLE CADDY

- Fully enclosed design conceals cable clutter
- Sturdy steel construction
- Generous amount of space in caddy opening
- Optional 8-outlet power strip

CABLE CADDY BASKET

- Control cables while maintaining easy access to wires
- Steel wire construction with powdercoated paint
- Black or Silver finish options
- Optional 8-outlet power strip

CABLE CADDY CLIPS

- Includes three wire management pieces
- Place these clips anywhere you need cable control
- Easy installation with four screws



CABLE CADDY SLIM

- Simple cable management solution
- Lightweight polymer construction
- Easily attaches to any smooth surface with included adhesive tape

SPECIFICATIONS

Model:	WM03 Cable Caddy	WM05 Cable Caddy Basket	WM01 Cable Caddy Slim
Dimensions			
Height	6"	6"	1.13"
Length	36"	26"	49"
Depth	4"	6"	2.5"

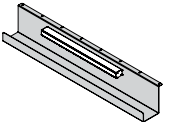
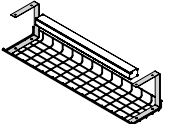
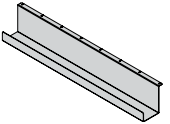
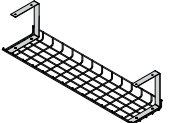
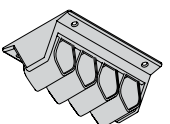
1. Wire Management and Power Strip Add-Ons

Product Type	Code	Price	
Power Strip			
Power Strip	3152 PST1 WM00	\$218	
Wire Management With Power			
Cable Caddy + Power	3152 PST1 WM03	\$396	
Cable Caddy Basket + Power	3152 PST1 WM05	\$316	
Wire Management Without Power			
Cable Caddy	3152 WM03	\$178	
Cable Caddy Basket	3152 WM05	\$98	
Cable Caddy Clips	3152 WM01	\$82	
Cable Caddy Slim	3152 WM02	\$64	
Color	Code	Price	
Black	WMC03	+ \$0	
Silver	WMC01	+ \$0	

Color options available on cable caddy basket (WM05) only.

CPU Storage

EFFECTIVE
NOVEMBER 4, 2024

Keep it clean.

Secure your PC with ease. Our CPU holder attaches to your workstation for a cleaner look.

CPU Under Desk/Wall Mount



CPU Storage Band



CPU Storage

Product	Code	Price
CPU Storage Band	3156 CPUS1	\$286
CPU Under Desk/Wall Mount	3156 CPUS3	\$144

Features and Specifications

BAND

- Supports most PC sizes (up to 52" in perimeter)
- Retracts on a 17" track with 360-degree swivel
- Quick and easy adjustments with an Allen key
- Weight capacity warranty: Up to 75 lb.

UNDER DESK/WALL MOUNT

- Slide-and-swivel movement makes adjustment easy
- Height range: 11.8"–21"
- Depth range: 3.5"–8"
- Track travel: 12.8"

Current

POWER

GSA SIN #: 33721
EFFECTIVE
NOVEMBER 4, 2024

Plug into productivity.

Our Current power module provides the charge you need to stay on task all day long.



Current Surface Clamp Mount

1. Current Collection

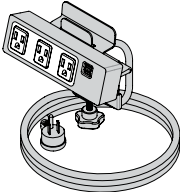
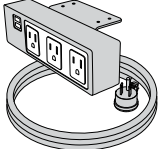
Product Type	Code	Price	
Surface Clamp Mount	3130 PCC	\$278	
Undermount Bracket	3130 PCU	\$319	

2. Color

Module and Cord Color	Code	Price	
White	PC4	+ \$0	
Black	PC1	+ \$0	

Features and Specifications

- Three outlets, 2 USB ports
- White finish features 3.1 amp; black finish comes with 2.1 amp
- Convenient tablet or phone holder built into clamp mount
- 15 amp, 125 volt
- Cord: 10 feet
- Surge protection: 510 joules
- Two USB charging ports; 3.1A combined
- UL/cUL listed (UL962A)

Empower your workspace.

Charge up (to keep up) with your day ahead. EON eliminates the struggle of finding an outlet with an easily accessible power source right at your fingertips. Keep your devices ready for any task with this line of convenient power modules.



Single Outlet, Dual USB

1. EON Collection

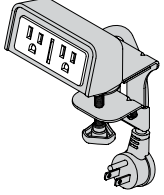
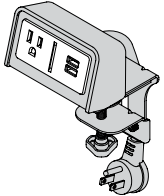
Product Type	Code	Price	
EON Clamp On, Dual Outlet	3130 PTC PT5	\$128	
EON Clamp On, Single Outlet, Dual USB	3130 PTC PT2	\$185	

2. Color

Module and Cord Color	Code	Price	
White	PC4	+\$0	
Black	PC1	+\$0	

Features

- Choose from dual-outlet or single-outlet/dual-USB setups
- AC outlet: 15A, 125V, 60Hz
- Quick-charge USB outlets: 3.1A, 5V
- Add an easy-to-access power source at worksurface level
- Installs with surface mount clamp
- Includes 8' power cord that is UL-listed

High Tide

SIT-TO-STAND

EFFECTIVE
NOVEMBER 4, 2024

Elevate your task.

Our High Tide offers an easy-to-install solution for converting desktops into an adaptable sit-to-stand, height-adjustable workstation.



High Tide 4

Features

- Infinite height-adjustment increments with lockable gas spring and a height-adjustable range of up to 19.25"
- Desktop size is 17.8" (W) x 32.5" (L);
Keyboard tray size is 6.6" (W) x 32.25" (L);
Overall size is 25.04" (W) x 32.62" (L)
- Desktop supports up to 33 lb;
Keyboard tray supports 4.4 lb
- Single monitor arm weight limit is 20 lb;
Dual monitor arm weight limit is 10 lb per monitor
- Dual monitor arm supports screens up to 22" (W)
- Single monitor arm pole is 12.59" (H);
Dual monitor arm pole is 16.59" (H)
- Desktop material is HDF with CARB certification

1. High Tide

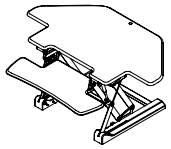
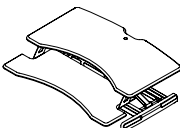
Model	Code	Price	
High Tide Corner Unit	3120 SSHT1	\$679	
High Tide 4	3120 SSHT4	\$573	

2. Monitor Arms

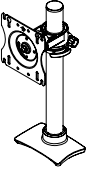
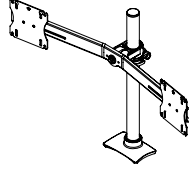
Sit/Stand Monitor Arm	Code	Price	
None	MAT00	+ \$0	
Single Screen	MAT25	+ \$362	
Dual Screen	MAT26	+ \$439	



High Tide Corner Unit

Keyboard Tray

GSA SIN #: 33721
EFFECTIVE
NOVEMBER 4, 2024

Lift, tuck and type.

Free up your workspace with our collection of convenient keyboard platforms and platform connectors.

Mini Trackless With Lift and Lock Mechanism



Features

LIFT AND LOCK

- Lift and lock provides 7 inches of height adjustment
- Includes knob for manual tilt adjustment
- 21.75" track

PREMIUM LIFT AND LOCK

- Lift and lock height adjustment with automatic tilt adjustment
- Patented height and tilt indicator
- 21.75" track

MINI TRACKLESS

- Designed to attach and function without a track
- Easily attaches below top to avoid crossbar interference

SIT-TO-STAND

- Lift and lock height adjustment with height range from 8" above the track to 6" below
- Control for tilt adjustment
- 23" track

1. Keyboard Tray

Product Type	Code	Price	
Keyboard Tray	3151	\$0	Priced by Style

2. Platform

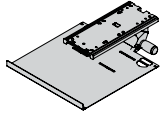
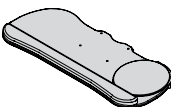
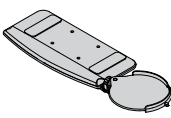
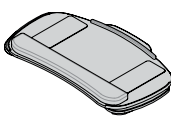
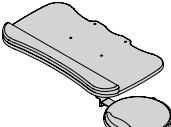
Platform Style	Code	Price	
None	KBP00	+ \$0	
Laptop Tray	KBP01	+ \$157	
Longboard	KBP02	+ \$272	
Mini Platform	KBP03	+ \$327	
Crescent Board	KBP04	+ \$317	
Tilt, Swivel Board	KBP05	+ \$304	

3. Mechanism

Mechanism Style	Code	Price	
None	KBM00	\$0	
HAT	KBM01	\$154	
Lift and Lock	KBM02	\$256	
Mini Trackless	KBM04	\$330	
Premium Lift and Lock	KBM05	\$349	
Sit-to-Stand	KBM06	\$449	

4. Miscellaneous

Options	Code	Price	
None	KBO00	+ \$0	
U-Brackets for Crossrails	KBTA	+ \$114	
Corner Sleeve	KBCS	+ \$202	

KEYBOARD TRAY

EFFECTIVE NOVEMBER 4, 2024 | GSA SIN #: 33721

Specifications

CRESCENT BOARD

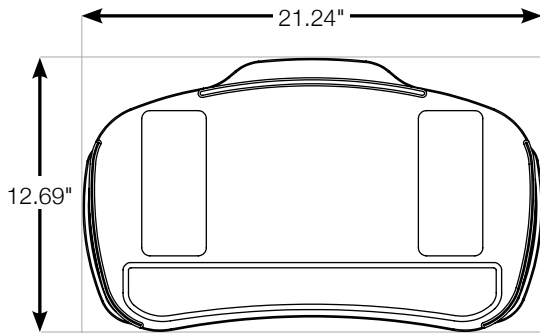

LONGBOARD

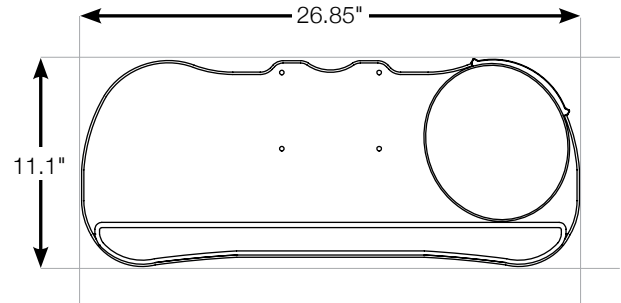

MINI PLATFORM

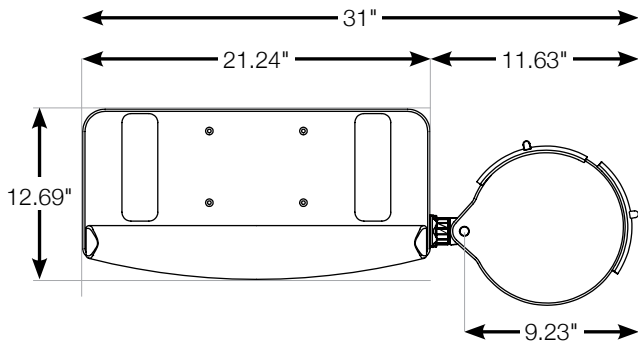

LAPTOP TRAY

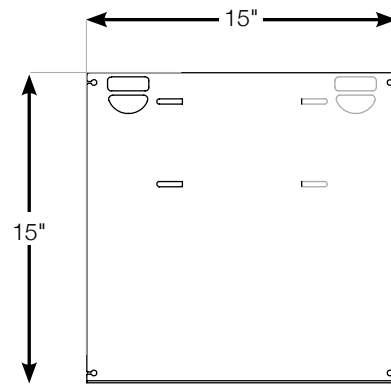

SWIVEL TILT

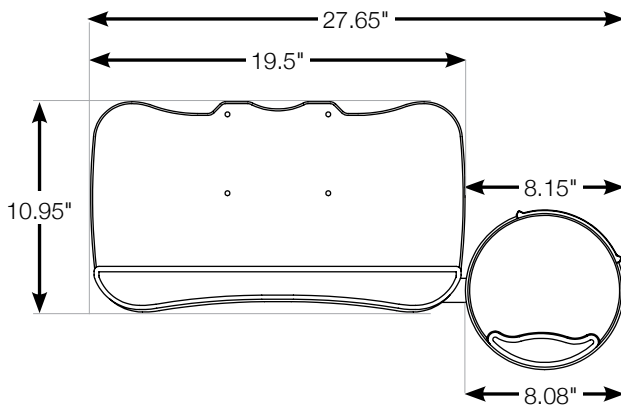

Laptop Storage

GSA SIN #: 33721
EFFECTIVE
NOVEMBER 4, 2024

Support and store.

Declutter, declutter. If you're tight on space or need to shift gears, our laptop storage is your go-to solution for an extra hand. These add-ons install under your desk and adjust left to right to fit your work needs.

1. Product

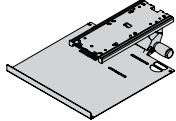
Product Style	Code	Price	
Laptop Tray	3154 LPT02	\$308	



Features and Specifications

- Adjusts left to right to fit in tight places
- Includes mechanism, track and mounting hardware
- Platform: 15" (W) × 15" (L)
- Desk attachment: 5.77" (W) × 12.75" (L)
- Available in black finish only

Mobile Pedestal

File with flexibility.

Our two-drawer mobile pedestal stores everything you need and can move out of the way while still being within reach.



*Mobile Pedestal With Upholstered Pad
Upholstered pad featured with SitOnIt Seating's Sugar – Electric Blue*

EFFECTIVE NOVEMBER 4, 2024

Featured Models

NO UPHOLSTERED PAD :: \$364

Mobile pedestal, silver finish, no upholstered pad

WITH UPHOLSTERED PAD :: \$508

Mobile pedestal, white finish, upholstered pad, grade 1 textile

MOBILE PEDESTAL

EFFECTIVE NOVEMBER 4, 2024

Features

- Five base wheels provide easy mobility
- Recessed pulls mean flat surfaces for safer work areas
- Optional cushion with colorful upholstery options
- Full extension drawer slides
- Compatible with legal and letter file sizes
- Silver, black and white finish options
- Drawer tested at 50,000 pull cycles

1. Product

Product Type	Code	Price	
--------------	------	-------	--

Mobile Pedestal	3150	\$364	
-----------------	------	-------	--

Product Style	Code	Price	
---------------	------	-------	--

No Upholstered Pad	CPT00	+ \$0	
--------------------	-------	-------	--

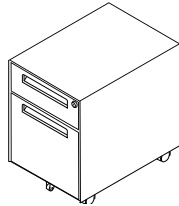

Upholstered Pad	CPT01	+ \$144	
-----------------	-------	---------	--

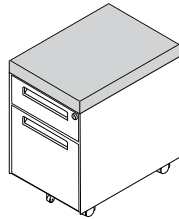

2. Pedestal Finish

Paint Color	Code	Price	
-------------	------	-------	--

Silver	PDC01	+ \$0	
--------	-------	-------	--

White	PDC02	+ \$0	
-------	-------	-------	--

Black	PDC03	+ \$0	
-------	-------	-------	--

STORAGE SOLUTION

3. Material

Material Grade	Code	Price	
Fabric/Vinyl Grade 1	FG1	+ \$0	
Fabric/Vinyl Grade 2	FG2	+ \$11	
Fabric/Vinyl Grade 3	FG3	+ \$30	
Fabric/Vinyl Grade 4	FG4	+ \$52	
Fabric/Vinyl Grade 5	FG5	+ \$90	
Fabric/Vinyl Grade 6	FG6	+ \$127	
Fabric/Vinyl Grade 7	FG7	+ \$165	

SPECIFICATIONS

	3150 Mobile Pedestal
Height	19.25"
Width	14.25"
Length	19.625"
Cushion Height	1.8"
Drawer Weight Capacity	88 lb
Stationary Weight Capacity (Including Weight of Drawer Contents)	250 lb



Mobile Pedestal With No Upholstered Pad

Pencil Storage

EFFECTIVE
NOVEMBER 4, 2024

Store and more.

When it comes to storing pens, pencils and more, our supply drawers are the "write" way to go—keeping everything organized and within reach.



Half Moon Pencil Drawer

1. Product

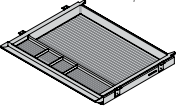
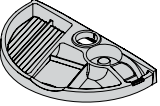
Product Style	Code	Price	
Rectangular Pencil Drawer	3155 PDT01	\$147	
Half Moon Pencil Drawer	3155 PDT02	\$125	

SPECIFICATIONS

Model:	3155 PDT01 Rectangular Pencil Drawer	3155 PDT02 Half Moon Pencil Drawer
Dimensions		
Height	1.94"	1.35"
Width	18.125"	8.23"
Length	22.75"	13.6"
Drawer Extension	11.5"	11.5"

Features

- Divided storage compartments for pens, pencils and other small supplies
- Includes easy-to-follow assembly instructions

A bright idea.

Promote bright ideas at every workstation with our value series lighting. It's sleek, simple and turns on with the wave of a hand.



28" Rhythm Lighting

SPECIFICATIONS

Model:	3140 Lighting
Dimensions With Mounts	
Height	1.80"
Length	28.07"
Depth	1.81"
Interconnecting Cable Length	5'
Power Cord Length	6'
Electrical	
Color Temperature	2800 K
LED-Rated Lifespan	50,000 Hours

1. Product

Product Type	Code	Price	
Lighting	3140	\$309	
Product Style	Code	Price	
28" Standard	LSV LFSV	+ \$0	
28" Daisy Chain Starter	LSV LFDV	+ \$80	

2. Add-On Light Fixtures

Quantity	Code	Price	
None	LFAV0	+ \$0	
One 28" Daisy Chain	LFAV1	+ \$268	
Two 28" Daisy Chain Starters	LFAV2	+ \$533	

3. Motion Sensor

Sensor	Code	Price	
None	LMS0	+ \$0	
Lighting With Motion Sensor	LMS1	+ \$135	

Features

- Motion-activated power button
- Built-in 12-hour automatic shut-off feature
- Mounts allow for infinite tilt adjustment for focusing the light
- Dimmer: 3 settings; motion-activated
- Brightness adjustability: 100%–50% in 3 stages
- Color finish: silver aluminum with black end caps
- Housing material: clear anodized aluminum
- Both wood screws and magnet mounts included

Appendix

HELPFUL REFERENCE MATERIAL

STAND-ALONE TABLETOPS

GSA SIN #: 33721

1. Table or Desk Top

Product Type	Code	Price
Tabletop or Desktop	3000	Priced by Size

2. Finish

Laminate	Code	Price
Grade 1 Laminate		
Ankara Cherry	TL18	Priced by Size
Black	TL19	Priced by Size
Brazilian Walnut	TL20	Priced by Size
Cabinet Maple	TL21	Priced by Size
Driftwood	TL23	Priced by Size
Folkstone Grey	TL24	Priced by Size
Libretti	TL25	Priced by Size
Queenston Oak	TL26	Priced by Size
Sandalwood	TL27	Priced by Size
Walnut Amati	TL28	Priced by Size
White	TL29	Priced by Size
Grade 2 Laminate		
Classic Linen	TL17	Priced by Size
Colombian Walnut	TL55	Priced by Size
Crisp Linen	TL64	Priced by Size
Designer White	TL66	Priced by Size
Field Elm	TL13	Priced by Size
Frosty White	TL16	Priced by Size
Grey	TL62	Priced by Size
Grey Elm	TL51	Priced by Size
Kingswood Walnut	TL53	Priced by Size
Manitoba	TL56	Priced by Size
Neo Walnut	TL50	Priced by Size
Platinum	TL61	Priced by Size
Portico Teak	TL60	Priced by Size
Skyline Walnut	TL15	Priced by Size
Steel Mesh	TL59	Priced by Size
Tuscan Walnut	TL57	Priced by Size
Uptown Walnut	TL14	Priced by Size
Laminate Grade	Code	Price
Laminate Grade 1	GR1	Priced by Size
Laminate Grade 2	GR2	Priced by Size

3. Shape

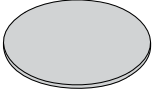
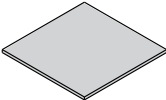
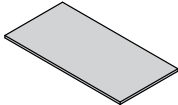
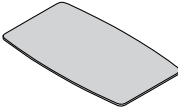
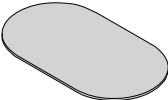
Tabletop Shape	Code	Price
Café and Occasional		
Round	TR	Priced by Size
		
Square	TS	Priced by Size
		
Multipurpose and Training		
Rectangular	TZ	Priced by Size
		
Meeting		
Wide Boat	TB	Priced by Size
		
Wide Racetrack	TK	Priced by Size
		

STAND-ALONE TABLETOPS

GSA SIN #: 33721

3. Shape (Cont.)

Tabletop Shape	Code	Price	
For 3-Leg Bases			
Right 90-Degree Tabletop	TBCR	Priced by Size	
Left 90-Degree Tabletop	TBCL	Priced by Size	
120-Degree Top	TA	Priced by Size	
Right Extended Corner	TXR	Priced by Size	
Left Extended Corner	TXL	Priced by Size	
Right Extended Offset Corner	OR	Priced by Size	
Left Extended Offset Corner	OL	Priced by Size	

4. Size

Top Size	Code	Price		
Round (D x W)		Grade 1	Grade 2 Flat Edge	Grade 2 Knife Edge
24"	2424	\$287	\$431	\$517
30"	3030	\$331	\$497	\$596
36"	3636	\$383	\$575	\$690
42"	4242	\$400	\$600	\$720
48"	4848	\$458	\$687	\$825
54"	5454	\$800	\$1,200	\$1,440
60"	6060	\$1,200	\$1,800	\$2,160

Actual size of 30" x 30" tabletop is 30.75" x 30.75"

4. Size (Cont.)

Top Size	Code	Price		
Square (D x W)		Grade 1	Grade 2 Flat Edge	Grade 2 Knife Edge
24"	2424	\$287	\$431	\$517
30"	3030	\$331	\$497	\$596
36"	3636	\$383	\$575	\$690
42"	4242	\$400	\$600	\$720
48"	4848	\$458	\$687	\$825
54"	5454	\$800	\$1,200	\$1,440
60"	6060	\$1,200	\$1,800	\$2,160
Standard Rectangular (D x W)		Grade 1	Grade 2 Flat Edge	Grade 2 Knife Edge
18" x 42"	1842	\$176	\$264	\$317
18" x 48"	1848	\$200	\$300	\$360
18" x 54"	1854	\$225	\$338	\$406
18" x 60"	1860	\$248	\$372	\$447
18" x 66"	1866	\$275	\$413	\$496
18" x 72"	1872	\$300	\$450	\$540
20" x 36"	2036	\$164	\$246	
20" x 42"	2042	\$190	\$285	
20" x 48"	2048	\$218	\$327	
20" x 54"	2054	\$255	\$383	
20" x 60"	2060	\$270	\$405	
20" x 66"	2066	\$299	\$449	
20" x 72"	2072	\$324	\$486	
24" x 36"	2436	\$196	\$294	
24" x 42"	2442	\$229	\$344	\$413
24" x 48"	2448	\$261	\$392	\$471
24" x 54"	2454	\$292	\$438	\$526
24" x 60"	2460	\$324	\$486	\$584
24" x 66"	2466	\$358	\$537	\$645
24" x 72"	2472	\$389	\$584	\$701
24" x 78"	2478	\$421	\$632	
24" x 84"	2484	\$453	\$680	
30" x 36"	3036	\$244	\$366	
30" x 42"	3042	\$285	\$428	\$514
30" x 48"	3048	\$324	\$486	\$584
30" x 54"	3054	\$366	\$549	\$659
30" x 60"	3060	\$404	\$606	\$728
30" x 66"	3066	\$445	\$668	\$802
30" x 72"	3072	\$484	\$726	\$810
30" x 78"	3078	\$526	\$789	
30" x 84"	3084	\$565	\$848	

STAND-ALONE TABLETOPS

4. Size (Cont.)

Top Size	Code	Price		
Standard Rectangular (D x W)		Grade 1	Grade 2 Flat Edge	Grade 2 Knife Edge
36" x 42"	3642	\$540	\$810	\$972
36" x 48"	3648	\$570	\$855	\$1,026
36" x 54"	3654	\$625	\$938	\$1,126
36" x 60"	3660	\$700	\$1,050	\$1,260
36" x 66"	3666	\$790	\$1,185	\$1,422
36" x 72"	3672	\$800	\$1,200	\$1,440
42" x 78"	4278	\$821	\$1,232	
42" x 84"	4284	\$885	\$1,328	
42" x 90"	4290	\$964	\$1,446	
42" x 96"	4296	\$1,008	\$1,512	
48" x 78"	4878	\$939	\$1,409	
48" x 84"	4884	\$1,008	\$1,512	
48" x 90"	4890	\$1,108	\$1,662	
48" x 96"	4896	\$1,152	\$1,728	
Rectangular for Use with eBEAM (D x W)		Grade 1	Grade 2 Flat Edge	Grade 2 Knife Edge
24" x 46"	2446	\$261	\$392	
24" x 58"	2458	\$324	\$486	
24" x 70"	2470	\$389	\$584	
30" x 46"	3046	\$324	\$486	
30" x 58"	3058	\$404	\$606	
30" x 70"	3070	\$484	\$726	
Wide Boat (D x W)		Grade 1	Grade 2 Flat Edge	Grade 2 Knife Edge
42" x 78"	4278	\$821	\$1,232	
42" x 84"	4284	\$885	\$1,328	
42" x 90"	4290	\$964	\$1,446	
42" x 96"	4296	\$1,008	\$1,512	
48" x 78"	4878	\$939	\$1,409	
48" x 84"	4884	\$1,008	\$1,512	
48" x 90"	4890	\$1,108	\$1,662	
48" x 96"	4896	\$1,152	\$1,728	

4. Size (Cont.)

Top Size	Code	Price		
Racetrack (D x W)		Grade 1	Grade 2 Flat Edge	Grade 2 Knife Edge
24" x 60"	2460	\$324	\$486	\$584
30" x 72"	3072	\$450	\$675	\$810
30" x 84"	3084	\$565	\$848	\$1,018
30" x 96"	3096	\$850	\$1,275	\$1,530
36" x 72"	3672	\$800	\$1,200	\$1,440
36" x 84"	3684	\$875	\$1,313	\$1,576
36" x 96"	3696	\$950	\$1,425	\$1,710
42" x 78"	4278	\$821	\$1,232	
42" x 84"	4284	\$885	\$1,328	
42" x 90"	4290	\$964	\$1,446	
42" x 96"	4296	\$1,008	\$1,512	
48" x 78"	4878	\$939	\$1,409	
48" x 84"	4884	\$1,008	\$1,512	
48" x 90"	4890	\$1,108	\$1,662	
48" x 96"	4896	\$1,152	\$1,728	
Right 90-Degree Top (D x W)		Grade 1	Grade 2 Flat Edge	Grade 2 Knife Edge
24" x 48"	2448	\$517	\$776	
24" x 54"	2454	\$582	\$873	
24" x 60"	2460	\$645	\$968	
30" x 48"	3048	\$645	\$968	
30" x 54"	3054	\$729	\$1,094	
30" x 60"	3060	\$805	\$1,208	
Left 90-Degree Top (D x W)		Grade 1	Grade 2 Flat Edge	Grade 2 Knife Edge
24" x 48"	2448	\$517	\$776	
24" x 54"	2454	\$582	\$873	
24" x 60"	2460	\$645	\$968	
30" x 48"	3048	\$645	\$968	
30" x 54"	3054	\$729	\$1,094	
30" x 60"	3060	\$805	\$1,208	
120-Degree Top (D x W)		Grade 1	Grade 2 Flat Edge	Grade 2 Knife Edge
24" x 42"	2442	\$705	\$1,058	
24" x 48"	2448	\$908	\$1,362	
30" x 42"	3042	\$736	\$1,104	
30" x 48"	3048	\$917	\$1,376	

STAND-ALONE TABLETOPS

4. Size (Cont.)

Top Size	Code	Price		
Right Extended Corner (A x B x C)		Grade 1	Grade 2 Flat Edge	Grade 2 Knife Edge
24" x 36" x 60"	243660	\$485	\$728	
24" x 36" x 66"	243666	\$547	\$821	
24" x 36" x 72"	243672	\$618	\$927	
24" x 42" x 60"	244260	\$557	\$836	
24" x 42" x 66"	244266	\$629	\$944	
24" x 42" x 72"	244272	\$710	\$1,065	
24" x 48" x 60"	244860	\$613	\$920	
24" x 48" x 66"	244866	\$692	\$1,038	
24" x 48" x 72"	244872	\$781	\$1,172	
30" x 36" x 60"	303660	\$557	\$836	
30" x 36" x 66"	303666	\$629	\$944	
30" x 36" x 72"	303672	\$760	\$1,140	
30" x 42" x 60"	304260	\$640	\$960	
30" x 42" x 66"	304266	\$723	\$1,085	
30" x 42" x 72"	304272	\$817	\$1,226	
30" x 48" x 60"	304860	\$672	\$1,008	
30" x 48" x 66"	304866	\$760	\$1,140	
30" x 48" x 72"	304872	\$860	\$1,290	
Left Extended Corner (A x B x C)		Grade 1	Grade 2	
24" x 60" x 36"	246036	\$485	\$728	
24" x 66" x 36"	246636	\$547	\$821	
24" x 72" x 36"	247236	\$618	\$927	
24" x 60" x 42"	246042	\$557	\$836	
24" x 66" x 42"	246642	\$629	\$944	
24" x 72" x 42"	247242	\$710	\$1,065	
24" x 60" x 48"	246048	\$613	\$920	
24" x 66" x 48"	246648	\$692	\$1,038	
24" x 72" x 48"	247248	\$781	\$1,172	
30" x 60" x 36"	306036	\$557	\$836	
30" x 66" x 36"	306636	\$629	\$944	
30" x 72" x 36"	307236	\$760	\$1,140	
30" x 60" x 42"	306042	\$640	\$960	
30" x 66" x 42"	306642	\$723	\$1,085	
30" x 72" x 42"	307242	\$817	\$1,226	
30" x 60" x 48"	306048	\$672	\$1,008	
30" x 66" x 48"	306648	\$760	\$1,140	
30" x 72" x 48"	307248	\$860	\$1,290	

4. Size (Cont.)

Top Size	Code	Price		
Right Extended Offset Corner (A x B x C x D)		Grade 1	Grade 2	
24" x 36" x 60" x 30"	24366030	\$531	\$797	
24" x 36" x 66" x 30"	24366630	\$604	\$906	
24" x 36" x 72" x 30"	24367230	\$685	\$1,028	
24" x 42" x 60" x 30"	24426030	\$616	\$924	
24" x 42" x 66" x 30"	24426630	\$697	\$1,046	
24" x 42" x 72" x 30"	24427230	\$793	\$1,190	
24" x 48" x 60" x 30"	24486030	\$648	\$972	
24" x 48" x 66" x 30"	24486630	\$735	\$1,103	
24" x 48" x 72" x 30"	24487230	\$835	\$1,253	
Left Extended Offset Corner (A x B x C x D)		Grade 1	Grade 2	
30" x 60" x 36" x 24"	30603624	\$531	\$797	
30" x 66" x 36" x 24"	30663624	\$604	\$906	
30" x 72" x 36" x 24"	30723624	\$685	\$1,028	
30" x 60" x 42" x 24"	30604224	\$616	\$924	
30" x 66" x 42" x 24"	30664224	\$697	\$1,046	
30" x 72" x 42" x 24"	30724224	\$793	\$1,190	
30" x 60" x 48" x 24"	30604824	\$648	\$972	
30" x 66" x 48" x 24"	30664824	\$735	\$1,103	
30" x 72" x 48" x 24"	30724824	\$835	\$1,253	

5. Grommets

Grommet Location	Code	Price	
No Grommets	GP00	+ \$0	

5. Add-Ons

Mending Plate	Code	Price	
None	TTMP0	+ \$0	
Mending Plate Kit	TTMP1	+ \$74	
Stiffener	Code	Price	
No Stiffener	STF00	+ \$0	
54" Stiffener (1 Each)	STF01	+ \$80	
54" Stiffeners (2 Each)	STF02	+ \$160	

Mending plate kits are available with tabletops that have a depth of 20", 24" or 30".

Stiffeners are available with and recommended for tabletops that have a depth of 42" or more and/or a width of 66" or more.

STAND-ALONE TABLETOPS

Table Weights

Top Size	Grade 1 Laminate	Grade 2 Laminate	
Round (D × W)			
24" × 24"	14 lb	15 lb	
30" × 30"	21 lb	23 lb	
36" × 36"	31 lb	34 lb	
42" × 42"	42 lb	46 lb	
48" × 48"	54 lb	60 lb	
Square (D × W)			
24" × 24	17 lb	19 lb	
30" × 30"	27 lb	30 lb	
36" × 36"	39 lb	43 lb	
42" × 42"	53 lb	58 lb	
48" × 48"	69 lb	76 lb	

Table Weights (Cont.)

Top Size	Grade 1 Laminate	Grade 2 Laminate	
Wide Boat (D × W)			
42" × 78"	89 lb	96 lb	
42" × 84"	96 lb	104 lb	
42" × 90"	103 lb	112 lb	
42" × 96"	109 lb	121 lb	
48" × 78"	103 lb	107 lb	
48" × 84"	111 lb	117 lb	
48" × 90"	119 lb	126 lb	
48" × 96"	127 lb	136 lb	
Wide Racetrack (D × W)			
42" × 78"	87 lb	98 lb	
42" × 84"	94 lb	105 lb	
42" × 90"	102 lb	113 lb	
42" × 96"	110 lb	120 lb	
48" × 78"	97 lb	113 lb	
48" × 84"	106 lb	122 lb	
48" × 90"	115 lb	131 lb	
48" × 96"	123 lb	139 lb	
Rectangular for Use with eBEAM (-2") (D × W)			
24" × 46"	33 lb	36 lb	
24" × 58"	42 lb	46 lb	
24" × 70"	50 lb	55 lb	
30" × 46"	41 lb	46 lb	
30" × 58"	52 lb	57 lb	

Actual size of 30" × 30" tabletop is 30.75" × 30.75"

STAND-ALONE TABLETOPS

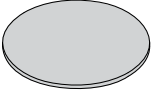
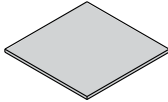
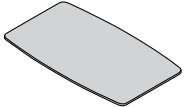
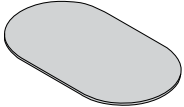
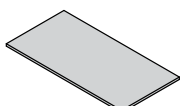
Table Weights (Cont.)

Top Size	Grade 1 Laminate	Grade 2 Laminate
Standard Rectangular (D x W)		
18" x 42"	23 lb	25 lb
18" x 48"	26 lb	29 lb
18" x 54"	29 lb	32 lb
18" x 60"	32 lb	36 lb
18" x 66"	36 lb	39 lb
18" x 72"	39 lb	43 lb
20" x 36"	22 lb	24 lb
20" x 42"	25 lb	28 lb
20" x 48"	29 lb	32 lb
20" x 54"	32 lb	36 lb
20" x 60"	36 lb	40 lb
20" x 66"	40 lb	44 lb
20" x 72"	43 lb	48 lb
24" x 36"	26 lb	29 lb
24" x 42"	30 lb	33 lb
24" x 48"	35 lb	38 lb
24" x 54"	39 lb	43 lb
24" x 60"	43 lb	48 lb
24" x 66"	48 lb	52 lb
24" x 72"	52 lb	57 lb
24" x 78"	56 lb	62 lb
24" x 84"	60 lb	67 lb
30" x 36"	32 lb	36 lb
30" x 42"	38 lb	42 lb
30" x 48"	43 lb	48 lb
30" x 54"	49 lb	53 lb
30" x 60"	54 lb	59 lb
30" x 66"	59 lb	65 lb
30" x 72"	65 lb	71 lb
30" x 78"	70 lb	77 lb
30" x 84"	76 lb	83 lb
42" x 78"	98 lb	108 lb
42" x 84"	106 lb	116 lb
42" x 90"	113 lb	125 lb
42" x 96"	121 lb	133 lb
48" x 78"	112 lb	124 lb
48" x 84"	121 lb	133 lb
48" x 90"	130 lb	143 lb
48" x 96"	138 lb	152 lb

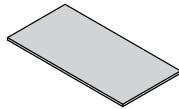
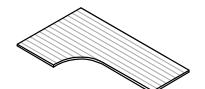
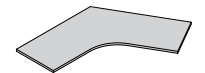
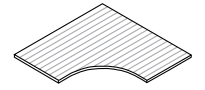
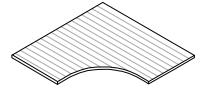

Table Weights (Cont.)

Top Size	Grade 1 Laminate	Grade 2 Laminate
Right 90-Degree Top (D x W)		
24" x 48"	54 lb	59 lb
24" x 54"	63 lb	69 lb
24" x 60"	71 lb	78 lb
30" x 48"	61 lb	68 lb
30" x 54"	72 lb	79 lb
30" x 60"	83 lb	91 lb
Left 90-Degree Top (D x W)		
24" x 48"	54 lb	59 lb
24" x 54"	63 lb	69 lb
24" x 60"	71 lb	78 lb
30" x 48"	61 lb	68 lb
30" x 54"	72 lb	79 lb
30" x 60"	83 lb	91 lb
120-Degree Top (D x W)		
24" x 42"	51 lb	56 lb
24" x 48"	60 lb	66 lb
30" x 42"	61 lb	67 lb
30" x 48"	71 lb	78 lb
Right Extended Corner (A x B x C)		
24" x 36" x 60"	52 lb	58 lb
24" x 36" x 66"	57 lb	62 lb
24" x 36" x 72"	61 lb	67 lb
24" x 42" x 60"	58 lb	63 lb
24" x 42" x 66"	62 lb	68 lb
24" x 42" x 72"	66 lb	73 lb
24" x 48" x 60"	63 lb	69 lb
24" x 48" x 66"	67 lb	74 lb
24" x 48" x 72"	71 lb	78 lb
30" x 36" x 60"	60 lb	66 lb
30" x 36" x 66"	65 lb	71 lb
30" x 36" x 72"	70 lb	77 lb
30" x 42" x 60"	65 lb	72 lb
30" x 42" x 66"	71 lb	78 lb
30" x 42" x 72"	76 lb	84 lb
30" x 48" x 60"	72 lb	79 lb
30" x 48" x 66"	77 lb	85 lb
30" x 48" x 72"	82 lb	91 lb



STAND-ALONE TABLETOPS

Table Weights (Cont.)

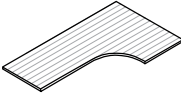
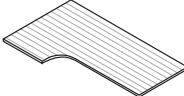
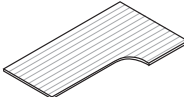
Top Size	Grade 1 Laminate	Grade 2 Laminate	
Left Extended Corner (A x B x C)			
24" x 60" x 36"	52 lb	58 lb	
24" x 66" x 36"	57 lb	62 lb	
24" x 72" x 36"	61 lb	67 lb	
24" x 60" x 42"	58 lb	63 lb	
24" x 66" x 42"	62 lb	68 lb	
24" x 72" x 42"	66 lb	73 lb	
24" x 60" x 48"	63 lb	69 lb	
24" x 66" x 48"	67 lb	74 lb	
24" x 72" x 48"	71 lb	78 lb	
30" x 60" x 36"	60 lb	66 lb	
30" x 66" x 36"	65 lb	71 lb	
30" x 72" x 36"	70 lb	77 lb	
30" x 60" x 42"	65 lb	72 lb	
30" x 66" x 42"	71 lb	78 lb	
30" x 72" x 42"	76 lb	84 lb	
30" x 60" x 48"	72 lb	79 lb	
30" x 66" x 48"	77 lb	85 lb	
30" x 72" x 48"	82 lb	91 lb	
A x B x C x D			
Right Extended Offset Corner			
24" x 36" x 60" x 30"	58 lb	64 lb	
24" x 36" x 66" x 30"	64 lb	70 lb	
24" x 36" x 72" x 30"	69 lb	76 lb	
24" x 42" x 60" x 30"	63 lb	69 lb	
24" x 42" x 66" x 30"	69 lb	75 lb	
24" x 42" x 72" x 30"	74 lb	81 lb	
24" x 48" x 60" x 30"	68 lb	75 lb	
24" x 48" x 66" x 30"	74 lb	81 lb	
24" x 48" x 72" x 30"	79 lb	87 lb	
A x B x C x D			
Left Extended Offset Corner			
30" x 60" x 36" x 24"	58 lb	64 lb	
30" x 66" x 36" x 24"	64 lb	70 lb	
30" x 72" x 36" x 24"	69 lb	76 lb	
30" x 60" x 42" x 24"	63 lb	69 lb	
30" x 66" x 42" x 24"	69 lb	75 lb	
30" x 72" x 42" x 24"	74 lb	81 lb	
30" x 60" x 48" x 24"	68 lb	75 lb	
30" x 66" x 48" x 24"	74 lb	81 lb	
30" x 72" x 48" x 24"	79 lb	87 lb	

SUPER DUTY SERIES GUIDE

Super Duty Series

When it comes to solutions built for uncompromising reliability, durability and comfortability — there's our Super Duty Series. Every side, task and tandem chair in the series features a combination of extra size, width, weight capacity warranty and more.

LIMITED 10-YEAR WARRANTY

SitOnIt Seating warrants the Heavy Duty Series for a period of 10 years when configured to the appropriate model. Fabric and foam cushioning are covered for two years.

TEXTILE DURABILITY

SitOnIt Seating recommends textiles that are high-density and abrasion-resistant, with at least a 75,000 double rub rating.



Heavy Duty

350 LB WEIGHT CAPACITY

- Standard seat and back
- Reinforced seat and heavy duty components
- Task Chairs: Amplify, Focus, Knack, ReAlign, and TR2
- Task Stools: Non-Stop Heavy Duty Stool and TR2



Large and Tall

400 LB WEIGHT CAPACITY

- Wide seat and standard back
- Thicker and firmer seat
- Reinforced seat and heavy duty components
- Task Chairs: Amplify, Focus, and Novo



Heavy Duty XL

500 LB WEIGHT CAPACITY

- Widest back and seat
- Thickest and firmest seat and back
- Reinforced seat and back, and heavy duty components
- Task Chair: Non-Stop

SUPER DUTY SERIES GUIDE

Large and Tall Options

SitOnIt Seating Large and Tall (LT) models are available as a standard to provide a fully coordinated and cohesive family offering on our Amplify, Focus and Novo task chairs. Large and Tall accommodates users up to 400 lb and SitOnIt Seating warrants for a period of 10 years used in multi-shift (24/7) applications.

Specify Large and Tall models by using the LT suffix when ordering. Add the appropriate additional charge for each chair. The list below summarizes the model, arm styles, mechanism, frame, back and base options.



Large and Tall (LT) Models

Large and Tall Options (List Price)	Amplify 2723 B1 Y A152 LT	Focus 5623 B1 Y A152 LT	Novo 1033 BK2 Y A152 LT
LT Base Model: Highback, Black Frame, Enhanced Synchro, Height-Adjustable With Sport Arm Pads	\$1,085	\$1,115	\$1,064
1. Arm Styles			
Height-Adjustable With Sport Arm Pads (A152)	+ \$0	+ \$0	+ \$0
Armless (A0)	- \$48	- \$90	- \$48
Height-/Width-Adjustable With Sport Arm Pads (A153)	+ \$30	+ \$25	+\$30
2. Seat Depth			
Seat Depth Adjustment (E3)	+ \$79	+ \$79	+ \$79
3. Frame			
Back Support Color	Black (FC1)	Black (Z1) or Silver (Z2)	Black (FC1)
4. Back			
Upholstered Back (B3/B4)	N/A	+ \$126	N/A
Adjustable Lumbar (LB1)	+ \$0	+ \$50	+ \$0
5. Base			
Polished Aluminum Base (B5)	+ \$167	+ \$167	+ \$167
Heavy Duty Hard Floor and Carpet Casters (C9)	+ \$61	+ \$61	+ \$61
High Heavy Duty Cylinder (S13)	+ \$0	+ \$0	+ \$0

SUPER DUTY SERIES GUIDE

Side Chair Collection



500 LB WEIGHT CAPACITY

Freelance Heavy Duty; Cora Guest, Hip Chair, Counter Stool and Bar Stool, Kindl 21"



600 LB WEIGHT CAPACITY

Cora Midsize and Freelance 30" Bariatric, Kindl 30"



750 LB WEIGHT CAPACITY

Cora Bariatric, Kindl 42"



1000 LB WEIGHT CAPACITY

Freelance Bariatric 42"

Lounge Collection



500 LB WEIGHT CAPACITY

Aviera Guest Seating, Hip Chair, Patient Seating (21"/24" Seat Width), Freespan 2-seat, Pre-configured 2-seat and 3-seat



750 LB WEIGHT CAPACITY

Aviera Bariatric Seating (30"/44" Seat Width), Freespan 3-Seat

GLIDE GUIDE

For almost 25 years, SitOnIt Seating products have been expertly designed to provide the best comfort and support in the industry.

Glides are an often overlooked element in the seating specification process, but they play a crucial role in ensuring proper interface between the chair and the floor.

This application guide offers general guidelines to assist customers with choosing the best glide for their needs. The guide is based on extensive lab testing and hands-on experience with selling chairs in a variety of environments, as well as review and consultations with glide experts.

Application Guide

Material

Surfaces

Material		Carpet	VCT	Vinyl	Laminate	Ceramic Tile	Hardwood	Concrete
Standard Multi-Surface Glides		Acceptable	Acceptable	Acceptable	Better	Better	NR	Better
Performance Multi-Surface Glides	Applies to Anytime, Baja, Cora, Freelance, Focus Side, InFlex, Lumin, Rio and Wit Side	Best	Better	Better	Better	Best	Better	Better
Floor Saver Glides		NR	Best	Best	Best	NR	Best	Best
Steel Glides (Carpet Only)		Better	NR	NR	NR	NR	NR	NR

Material

Surfaces

Material		Carpet	VCT	Vinyl	Laminate	Ceramic Tile	Hardwood	Concrete
No Glides	Applies to Baja, Lumin, Mika, OnCall, Orbix, Rio, Rowdy and Sprout	Best	NR	NR	NR	NR	NR	NR
Clear Glides		NR	NR	Acceptable	Better	Better	NR	Acceptable
Clear Glides With Felt		NR	Better	Better	Best	NR	Better	NR

Felt glides are subject to wear and tear and require periodic replacement.

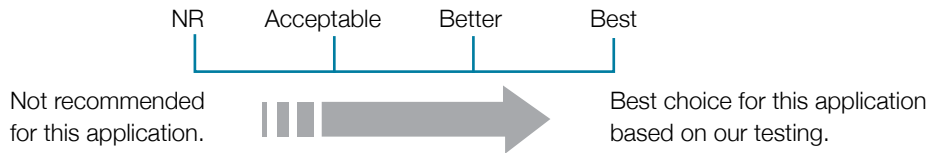

- **BEST:** Best choice for this application based on our testing.
- **BETTER:** Better choice for this application based on our testing.
- **ACCEPTABLE:** Acceptable choice for this application based on our testing but consider BETTER or BEST options.
- **NR:** Not recommended for this application based on our testing.

This Application Guide is provided for informational purposes only. Always follow the manufacturer's instructions for care and maintenance of your flooring. Periodic inspection and maintenance of glides is critical to minimize the risk of damage to your flooring, especially when using glides with floors that are prone to scratching and marring. Testing was performed under simulated conditions. Because a wide range of factors impact actual performance, including how your chairs are used; the state of the glides and flooring; and dirt, moisture and other environmental factors, Exemplis does not warrant you will achieve any specific result. Actual results may vary.

STACKING GUIDE

Discover stacking compatibility with Sitonit Seating's multipurpose products—including a list of SitOnIt models with a wall-saver frame.

4-Leg

Collection	Plastic Seat and Back	Upholstered Seat With Plastic Back	Upholstered Seat and Back	Wall-Saver Frame
On Cart				
Achieve (Glides Only)	—	5	5	•
Anytime (Glides Only)	8	8	8	
Baja (Glides Only)	10	8	8	
Cora Guest (Glides Only)	—	—	6	•
Freelance (Glides Only)	6	6	6	•
InFlex (Glides Only)	12	Arms NR, 10 Armless	Arms NR, 10 Armless	
Lumin (Glides Only)	8	6	6	
Mika (Glides Only)	12	12	—	
Relay (Glides Only)	5	5	5	•
Rio (Glides Only)	8	7	7	
On Floor				
Achieve (Casters and Glides)	—	4	4	•
Anytime (Glides Only)	6	6	6	
Baja (Casters and Glides)	6	4	4	
Cora Guest (Casters and Glides)	—	—	4	•
Freelance (Casters and Glides)	4	4	4	•
InFlex (Casters and Glides)	5	Arms NR, 5 Armless	Arms NR, 5 Armless	
Lumin (Casters and Glides)	6	4	4	
Mika (Casters and Glides)	3	9	—	
Relay (Glides Only)	5	5	5	•
Rio (Casters and Glides)	4	3	3	

4-Leg Mesh

Collection	Plastic Seat Mesh Back	Upholstered Seat With Mesh Back	Fully Upholstered Seat and Back	Wall-Saver Frame
On Cart				
Focus Side (Glides Only)	—	5	3	•
Wit Side (Glides Only)	4	4	4	•
On Floor				
Focus Side (Glides or Casters)	—	4	3	•
Wit Side (Glides or Casters)	4	NR	NR	•

Freelance sled base and bariatric models are not stackable. Relay nester stacks three on the floor: vertical. Ioniq and Qwiz do not stack.

Please note that chairs with a tablet arm do not stack. Chairs with casters do not stack on a cart.

Please use caution when stacking models with casters to prevent frame damage. SitOnIt Seating does not warrant scratched frames.

NR — Not recommended.

STACKING GUIDE

Wire Rod

Collection	Plastic Seat and Back	Upholstered Seat With Plastic Back	Upholstered Seat and Back	Wall-Saver Frame
On Cart				
Baja (Glides Only)	6	4	4	
Lumin (Glides Only)	15	6	6	
Mika	30	12	—	
OnCall (Glides Only)	20 With Arms, 25 Armless	NR	NR	•
Orbix	25	NR	—	
Rio (Glides Only)	15	6	6	
Rowdy (Glides Only)	25 With Arms, 40 Armless	NR	NR	
Sprout	40	—	—	
On Floor				
Baja	6	6	6	
Lumin	8	4	4	
Mika	3	6	—	
OnCall	8	NR	NR	•
Orbix	6	NR	—	
Rio	6	5	5	
Rowdy	10 With Arms, 15 Armless	NR	NR	
Sprout	10	—	—	

Nester

Collection	Plastic Seat and Back	Plastic Seat and Mesh Back	Upholstered Seat and Mesh Back	Upholstered Seat and Back
On Floor				
Flyte	3	3	4	4

Stacking with vinyl seats is not recommended.

Stool

Collection	Plastic Seat and Back	Upholstered Seat With Plastic Back	Upholstered Seat and Back	Wall-Saver Frame
On Floor				
Baja	4	4	4	
Mika	3	3	—	
OnCall	4	NR	NR	•
Orbix	6	NR	—	

Freelance sled base and bariatric models are not stackable. Focus Side wood back models are not stackable. Relay nester stacks three on the floor: vertical. Ioniq and Qwiz do not stack.

Please note that chairs with a tablet arm do not stack. Chairs with casters do not stack on a cart.

Please use caution when stacking models with casters to prevent frame damage. SitOnIt Seating does not warrant scratched frames.

NR — Not recommended.

ARM ADJUSTMENT GUIDE

SitOnIt Seating offers a wide variety of arm styles and adjustments to accommodate all types of users doing a wide variety of tasks. The general adjustments for each arm type are described below. See the website or the product hang tag for specifics.

Armless

Any discussion of arm styles must begin with armless. Armless chairs and stools are less expensive and are easier to get in and out of. However, they do not provide ergonomic support for long-term sitting and task functions.

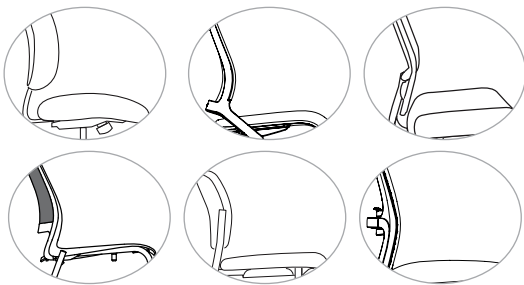

Most chairs and stools are available armless, but the selection may be limited to specific models. For instance, Freelance multipurpose chairs and stools can be specified armless, but not Freelance bariatric chairs.

Fixed

As the name implies, fixed arms cannot be adjusted. Also known as loop arms, cantilever arms and other names, these arms are commonly found on side and multi-seating as well as basic task seating.

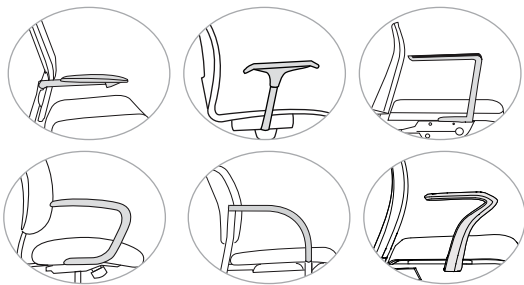

Height-Adjustable

This is the most basic adjustable arm. The arm adjusts up or down. Height-adjustable arms are best for basic task work.

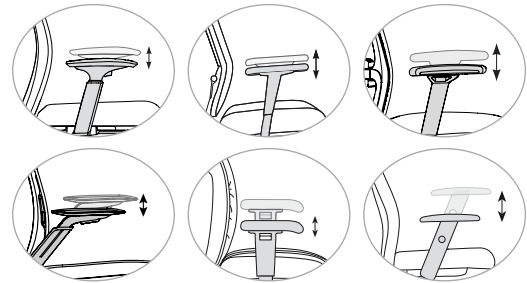

INSTRUCTIONS:

Glove Active, Knack, Non-Stop Heavy Duty, ReAlign, TR2 and Vectra

- To increase or decrease the arm height, press the button and pull up or push down on the arm.

Amplify, Focus, Focus 2.0, Vectra and Wit

- To increase arm height, press the button located under the front of the arm pad and pull the arm up.
- To decrease arm height, press the button located under the front of the arm pad and push the arm down.

Height-adjustable arms are available for Amplify, Focus, Focus 2.0, Glove Active, Knack, Non-Stop Heavy Duty, Novo, ReAlign, TR2, Vectra and Wit.

ARM ADJUSTMENT GUIDE

Height-/Width-Adjustable | Multi-Adjustable

Height-/width-adjustable arms are sometimes called multi-adjustable arms on certain products. The arm adjusts up and down and side to side. This provides more “elbow room” for larger people. Best for basic task work.

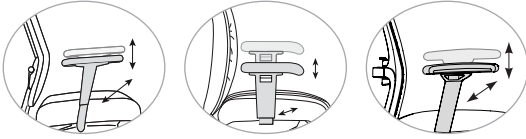

INSTRUCTIONS:

- Height: See instructions in the height-adjustable section.
- Width: To adjust the arm width, push down the lever located under the seat to unlock the width adjustment. Move the arm to the desired width and pull up the lever to lock the arm in place.

Height-/width-adjustable arms are available for Focus, Glove Active, Knack, Non-Stop Heavy Duty, ReAlign and TR2.

Multi-adjustable arms are available for Amplify, Focus 2.0, Novo, Torsa and Vectra.

Height-Adjustable With Pivot

The arm adjusts up and down and 30-degrees in or out. The arms can be turned in to facilitate writing or keyboarding and turned out for other tasks.

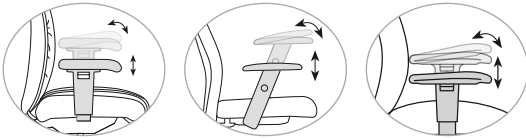

INSTRUCTIONS:

- Height: To increase or decrease the arm height, press the button.
- Pivot: The armrest has three positions: 30-degrees in, center or 30-degrees out. To pivot the arm, grasp the arm pad and move it to one of the three positions.

Height-adjustable arms with pivot are available for Glove Active, ReAlign and TR2.

Height-/Width-Adjustable With Pivot | Multi-Adjustable (Height/Width) With Pivot

This arm adjusts up and down, side to side and 30° in or out.

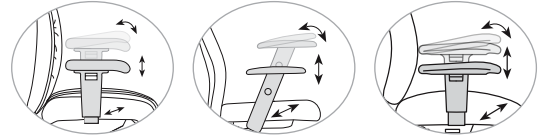

INSTRUCTIONS:

- Height: The arm adjusts up or down. To increase or decrease the arm height, press the button.
- Width: The arm adjusts side to side. To adjust the arm width, push down the lever located under the seat to unlock the width adjustment. Move the arm to the desired width and pull up on the lever to lock the arm in place.
- Pivot: The armrest has three positions: 30° in, center or 30° out (Non-Stop Heavy Duty pivots 15-degrees). To pivot the arm, grasp the arm pad and move it to one of the three positions.

Height-/width-adjustable arms with pivot are available for Glove Active, Non-Stop Heavy Duty, ReAlign and TR2.

Height-Adjustable Break-Away

The arm adjusts up or down and folds down 90-degrees. The folding arm allows for fast and easy ingress and egress and is also great for users with large key rings, tool belts or other personal gear.



INSTRUCTIONS:

- Height: The arm adjusts up or down. To increase or decrease the arm height, press the button.
- Break-Away: To fold the arm back, push down the lever located under the seat to unlock the arm and move the arm back. To return the arm to the original position, pull the arm up until it locks into place.

Height-adjustable break-away arms are available for Non-Stop Heavy Duty (stool only).

ARM ADJUSTMENT GUIDE

Multi-Adjustable (Height/Width) Articulating

The articulating arm adjusts up and down and side to side while the arm pad pivots left and right.



Non-Stop Heavy Duty offers a multi-adjustable articulating arm option.

Fully Adjustable (6-Way)

The six fully adjustable arm adjustments are arm height (up/down), arm pad depth (forward/back) and arm pad side to side (in/out). This ergonomic arm is good for users engaged in a variety of task applications.

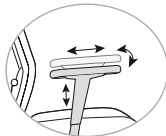

INSTRUCTIONS:

- Height: The arm adjusts up or down. To increase or decrease the arm height, press the button.
- Arm pad depth: The arm pad slides forward or back.
- Width: The arm adjusts side to side.

Fully adjustable (6-way) arms with arm pad depth adjustment are available exclusively on Focus.

Fully Adjustable (6-Way) With Pivot

The six fully adjustable arm adjustments are arm height (up/down), arm pad depth (forward/back) and pivot. This ergonomic arm is good for users engaged in a variety of task applications.

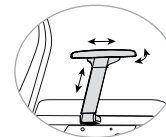

INSTRUCTIONS:

- Height: The arm adjusts up or down. To increase or decrease the arm height, press the button.
- Arm pad depth: The arm pad slides forward or back.
- Pivot: The armrest has three positions: 25° in, center, or 25° out.

Fully adjustable (6-way) arms with pivot are available on Sona and Prava.

Fully Adjustable (8-Way)

The 8-way fully adjustable arms go up/down for height adjustment while the arm pads go forward/back, in/out and pivot in/out for robust support. This all-encompassing arm style makes a perfect fit for today's workplace where broader work applications such as use of smartphones, tablets and other tech accessories are becoming the norm (and require complete forearm support). Pivoting of the arm pads also means that even the most petite of users can adjust accordingly for a more suitable fit.

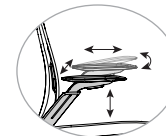

INSTRUCTIONS:

- Height: The arm adjusts up or down. To increase or decrease the arm height, press the button.
- Arm pad depth: The arm pad slides forward or backward.
- Arm pad lateral: The arm pad moves in and out. Not to be confused with the arm width adjustment where the entire arm moves.
- Arm pad pivot: The arm pad pivots in and out to accommodate various work application postures.

Fully adjustable (8-way) arms are available on Focus 2.0 and Vectra.

ARM ADJUSTMENT GUIDE

Fully Multi-Adjustable (10-Way)

The 10-way arm adjustments are arm height, arm width, arm pad depth, arm pad side to side and pivot. This is an excellent ergonomic task chair for executives or workers.

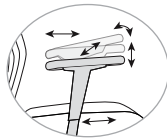

INSTRUCTIONS:

- Height: The arm adjusts up or down. To increase or decrease the arm height, press the button.
- Width: The arm adjusts side to side. To adjust the arm width, push down the lever located under the seat to unlock the width adjustment. Move the arm to the desired width and pull up on the lever to lock the arm in place.
- Arm pad depth: The arm pad slides forward or back.
- Arm pad side to side: The arm pad slides from side to side. Not to be confused with the arm width adjustment where the entire arm moves.
- Pivot: The armrest has three positions: 30-degrees in, center or 30-degrees out. To pivot the arm, grasp the arm pad and move it to one of the three positions.

Fully multi-adjustable (10-way) arms available exclusively on Focus.

MECHANISM FUNCTION GUIDE

SitOnIt Seating offers a wide range of function levels on our seating products. The descriptions and illustrations below are designed to introduce you to these mechanical functions and their primary advantages.

Standard Synchro (F)

Use for a variety of task environments. This 1.5:1 ratio synchro offers simple features for the budget-conscious buyer.

FEATURES

- Swivels 360°
- Gas cylinder seat height adjustment
- 1.5:1 seat to back synchronized recline movement
- Upright two-position tilt lock
- Tilt tension control
- Anti-kick feature
- Optional seat-depth adjustment on some models

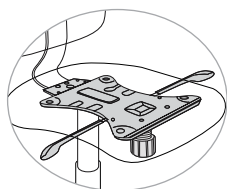

Standard synchro mechanism available on Hexy, Knack, Novo and Wit.

Enhanced Synchro (Y)

Use for a variety of task positions and extended hours of usage. This 2:1 ratio synchro offers smooth and easy-to-operate adjustments combined with maximum user comfort while ensuring correct posture and support. Allows for a full range of movement.

FEATURES

- Swivels 360°
- Gas cylinder seat-height adjustment
- 2:1 seat to back synchronized recline movement
- Upright two-position tilt lock
- Side tilt tension control
- Anti-kick feature

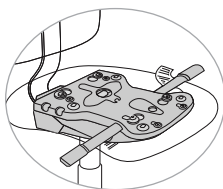

Internal back height adjustment not available on Focus and Prava.

Enhanced Synchro mechanism is available on Amplify, Focus, Focus 2.0, Glove Active, Knack, Prava, ReAlign, Sona, TR2 and Vectra.

Enhanced Synchro with Seat-Depth Adjustment (Y/E3)

Ideal for a variety of task positions and extended hours of usage.

This 2:1 ratio synchro offers smooth and easy-to-operate adjustments combined with maximum user comfort while ensuring correct posture and support. Allows for a full range of movement.

FEATURES

- Cable-driven control mechanism
- Swivels 360-degrees
- Gas cylinder seat height adjustment
- 2:1 seat to back synchronized movement
- Easy-to-adjust side activated tension control
- Upright two-position tilt lock
- Anti-kick feature
- Seat depth adjustment

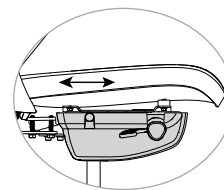

Enhanced Synchro with Seat Depth Adjustment is available on Amplify, Focus, Focus 2.0, Prava, Torsa and Vectra.

Internal back height adjustment not available on Focus and Prava.

Comfort Drive is available exclusively on Torsa.

Floating Synchro with Seat Depth Adjustment (SF/E3)

Ideal for a variety of task positions and extended hours of usage in an all-mesh task chair. This 2:1 ratio synchro offers smooth and easy to operate adjustments combined with maximum user comfort while ensuring correct posture and support. Allows for a full range of movement.

FEATURES

- Swivels 360°
- Gas cylinder seat height adjustment
- 2:1 seat to back synchronized movement
- Easy-to-adjust side activated tilt tension control
- Upright 4-position tilt lock
- Anti-kick feature
- Seat depth adjustment

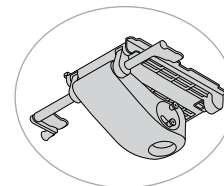

Floating Synchro mechanism with Seat Depth Adjustment available on Lavo.

MECHANISM FUNCTION GUIDE

Advanced Synchro with Seat-Depth Adjustment (L/E3)

Use for today's variety of task positions and usages. Discover easy, intuitive adjustments with easy-to-reach, rapid-adjust controls for ongoing ergonomic support/comfort.

- Rapid-adjust tension knob with five positive clicks; experience tightest to loosest tension in fewer than two turns
- Easy-to-adjust tilt limiter knob with positive clicks; enables tilt-limitation and continuous support in five positions up to 19°
- 2.3:1 ratio synchro
- Swivels 360-degrees
- Built-in seat depth adjustment lever

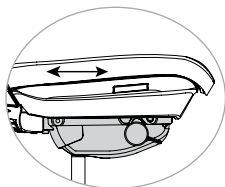

Advanced synchro mechanism available exclusively on Vectra.

Swivel-Tilt (T)

Use for a variety of tasks and conferencing. Lean back and relax, or lock in the upright position and task with solid support.

- Swivels 360°
- Gas cylinder seat height
- Seat and back tilt as unit
- Tilt tension control
- Upright position tilt lock

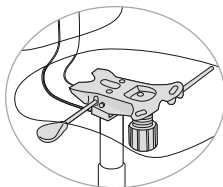

Swivel-tilt mechanism available on Knack, ReAlign and Sona. Swivel tilt mechanism is available on Focus, Focus 2.0, Glove Active, Glove Executive, Knack, Mavic, Non-Stop Heavy Duty, Novo, OnCall, Prava, ReAlign, Relay, Sona and TR2.

Knee Tilt (K)

Use for executive and managerial positions. The best of traditional tilt performance with a simple locking function. Allows for a full range of movement.

- Swivels 360°
- Gas cylinder seat height
- Seat and back tilt as unit
- Upright position tilt lock
- Tilt tension control
- Reduced rise on front seat edge

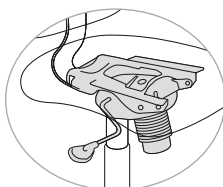

Knee-tilt is available on Focus, Glove Executive, Prava, ReAlign, Sona and TR2.

Posture Back (P)

Ideal for shared workstations. Perfect for limited task applications. Independent back articulation ideal for extended stool models.

- Swivels 360°
- Gas cylinder seat height
- Infinite back angle adjustment
- Optional seat-depth adjustment

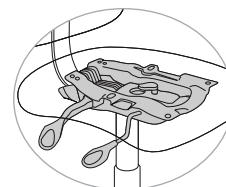

The posture back mechanism is available only on TR2.

Dual Torsion – Heavy Duty (DT)

Use for a variety of tasks and conferencing. Synchronized double-action rise allows full back recline for leg comfort and minimal front rise.

- Swivels 360-degrees
- Gas cylinder seat height
- Seat and back tilt as unit
- Upright position tilt lock
- Tilt tension control
- Reduced rise on front seat edge

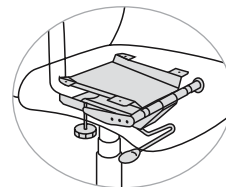

Dual torsion heavy duty mechanism available only on Non-Stop Heavy Duty.

Multi-Function (M)

Use for a variety of task positions and extended hours of usage. This control allows for an infinite range of movement and adjusts to a 5-degrees forward tilt.

- Swivels 360°
- Gas cylinder seat height
- Infinite back angle adjustment
- Seat and back tilt as unit
- Infinite position tilt lock
- Free floats in unlocked position
- Tilt tension control
- Seat pivots in a 5° forward position
- Optional seat depth adjustment

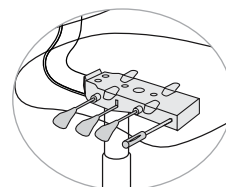

Non-Stop Heavy Duty models have a manual back height adjustment. Multi-function mechanism available on Glove Active, Knack, ReAlign and TR2.

Weight-Activated (WA)

This control includes a weight-activated back recline tension control and a tilt-limiter function

- Height-adjustment
- Seat depth adjustment
- Recline tension override: if you need more or less tension than the one set by the mechanism automatically
- Tilt limiter sets how far the chair can be reclined

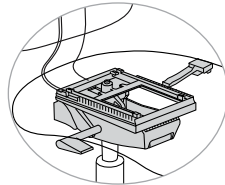

INSTRUCTIONS:

- Recline tilt limiter: The tilt limiter is integrated into the height-adjustment control. Pull the paddle all the way out to lock the chair to a fully upright position. The three grooves in the handle correspond to three tilt ranges. Push the paddle in and the mechanism will subtly click into the groove when adjusted, locking in the range.
- Recline tension override feature: Pull the control out of its stowed position and turn to your right (clockwise from seated position) to increase the amount of tension. The mechanism has a total range of 18 half-turns. The default setting is five half-turns, which is perfect for shared collaborative applications. For longer task applications, try three more halfturns to the right.
- Height-adjustment: Facing forward, the single control paddle is under the seat on the right. Pull up on the paddle to adjust. Stand slightly to raise the seat. Sit to lower the seat.
- Seat slider: While seated, locate the tab on the left side of the chair. Pull lever out to adjust the seat position. Slide seat forward or back to desired setting.

Weight-Activated mechanism available on Mavic.

Safety First

To ensure proper cleaning and/or disinfecting, it's important to consult with facilities or safety personnel and follow the manufacturer's instructions—including detailed dilution requirements, safe application instructions, dwell time for effective disinfecting and more.

Per CDC instructions, always read and follow the directions on the label to ensure safe and effective use.

- Wear skin protection and consider eye protection for potential splash hazards
- Ensure adequate ventilation
- Use no more than the amount recommended on the label
- Use water at room temperature for dilution (unless stated otherwise on the label)
- Avoid mixing chemical products
- Label diluted cleaning solutions
- Store and use chemicals out of the reach of children and pets

Always read and follow the directions on the cleaner/disinfectant labels to ensure safe and effective use.

Clean + Disinfect

Cleaning and disinfecting are two distinct actions, and knowing the difference between the two can help promote safety in any space. This comprehensive, 2-step process requires cleaning before disinfecting.

Clean

CLEANING REMOVES GERMS

- The act of removing visible dirt and debris from objects or surfaces
- Cleaning works by using soap/detergent with water to remove impurities from surfaces either manually or mechanically
- Cleaning does not kill germs, but by removing them, it lowers their numbers and risk of spreading infection

Clean (Cont.)

CLEANING GUIDELINES AND TIPS

- Start by lightly dusting with a soft, grit-free cloth or chamois (no wiping)
- After dusting, dampen cloth or chamois with a solution of mild, non-abrasive liquid soap and water
- Wipe clean and dry with a soft, grit-free cloth, sponge or chamois
- Avoid using abrasive cleaners and steel wool to prevent scratching
- Test any cleaning method or agent in an inconspicuous area of the surface

Disinfect

DISINFECTING KILLS GERMS

- This process comes after a surface is cleaned
- Disinfecting kills germs on objects or surfaces with the use of chemicals
- Most common disinfectants include one of the following active ingredients: Quaternary Ammonium (Quats), Sodium Hypochlorite (Bleach), Hydrogen Peroxide, or 70% Isopropyl Alcohol
- EPA-registered disinfectants List N: Disinfectants for Use Against SARS-CoV-2

DISINFECTING GUIDELINES AND TIPS

- Follow the disinfectant manufacturer's instructions when applying the agent
- Once finished, remove all disinfecting agents from the surface with water and a grit-free cloth, then dry
- If not properly removed, disinfectant residue could degrade product life and appearance

Cleaning + Disinfecting efforts should be part of an organization's comprehensive systems-based approach to provide a safe and sustainable workspace.

Cleaning Our Hard Surfaces

Over 95% of the hard surfaces on our products can be cleaned/disinfected using any one of the four primary ingredients listed below.

- Bleach (Sodium Hypochlorite)
- Hydrogen Peroxide
- Quaternary Ammonium Compounds (Quats)
- 70% Isopropyl Alcohol

EXAMPLES OF HARD SURFACES THAT CAN BE DISINFECTED:

- Plastics (i.e. polyurethane and acrylic)
- Solid Surface
- Metals
- Painted Surfaces
- Laminate

EXCEPTIONS:

- Markerboard
- Veneer
- Wood Surfaces

Clean + Disinfect

Cleaning and disinfecting are two distinct actions, and knowing the difference between the two can help promote safety in any space. This comprehensive, 2-step process requires cleaning before disinfecting.

Cleaning Our Soft Surfaces

Our textiles and meshes offer a performance and cleaning story unmatched in the industry.

Our Carded Textile Program offers over 700 bleach-cleanable fabrics through our SitOnIt Seating private label and partnership textile program.

MESH:

- All of our mesh materials are bleach-cleanable. This determination is supported by 3rd-party results from completing AATCC 188 Colorfastness to Bleach testing where the subject material is submerged, and friction stirred in a diluted sodium hypochlorite solution.
- Cleaning of our mesh materials varies. Check out the [Mesh Spec + Care Guide](#) on our website for more information.

SEATING FABRICS:

- Soft surfaces on seating can vary widely from woven, knits and leather to coated textiles such as vinyl and polyurethane. Woven and knits tend to be more permeable than vinyl or polyurethane.
- Cleaning of our seating fabric materials varies. For a list of our textile spec + care guides, see the [Materials Downloads](#) on our website.
- For a list of bleach-cleanable materials, see our [Carded Library](#) and select "Bleach Cleanable" under performance.

SCREEN FABRICS:

- Cleaning of screen materials varies. For a list of our textile spec + care guides, see the [Materials Downloads](#) on our website.
- For a list of bleach-cleanable materials, see our [Carded Library](#) and select "Bleach Cleanable" under performance.

LAMINATE COLOR PROGRAM

The following collections are available in the laminate color program: Cameo, Nano, Ocala, Parallon, Paséa, Switchback, Tensor and Uni. No minimum orders or additional costs apply.

Laminates

	Aviera	Composium	Envoi	Gobi	Mezzanine	Visit Modular
Grade 1						
Amber Mahogany	FCW3	FCW3	—	—	FCW3	FCW3
Clear Maple	FCW1	FCW1	—	—	FCW1	FCW1
Columbian	—	—	BF09	BF09	—	—
Espresso	FCW4	FCW4	—	—	FCW4	FCW4
Medium Cherry	FCW2	FCW2	—	—	FCW2	FCW2
Skyline	—	—	BF10	BF10	—	—
Uptown	—	—	BF08	BF08	—	—

LAMINATE COLOR PROGRAM











The following collections are available in the laminate color program: Cameo, Nano, Ocala, Parallon, Paséa, Switchback, Tensor and Uni. No minimum orders or additional costs apply.

Laminates







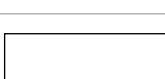



	Cameo	Nano	Ocala	Parallon	Paséa	Switchback	Tensor	Uni
Grade 1								
Ankara Cherry	—	—	TL18	TL18	—	TL18	TL18	—
Black	—	—	TL19	TL19	—	TL19	TL19	—
Brazilian Walnut	—	—	TL20	TL20	—	TL20	TL20	—
Cabinet Maple	—	—	TL21	TL21	—	TL21	TL21	—
Driftwood	—	—	TL23	TL23	—	TL23	TL23	—
Folkstone Grey	—	—	TL24	TL24	—	TL24	TL24	—
Libretti	—	—	TL25	TL25	—	TL25	TL25	—
Queenston Oak	—	—	TL26	TL26	—	TL26	TL26	—
Sandalwood	—	—	TL27	TL27	—	TL27	TL27	—
Walnut Amati	—	—	TL28	TL28	—	TL28	TL28	—
White	—	—	TL29	TL29	—	TL29	TL29	—
Grade 2								
Classic Linen	TL17	TL17	TL17	TL17	TL17	TL17	TL17	—
Colombian Walnut	TL55	—	TL55	TL55	—	TL55	TL55	—
Crisp Linen	TL64	—	TL64	TL64	—	TL64	TL64	—
Designer White	TL66	—	TL66	TL66	—	TL66	TL66	—
Field Elm	TL13	TL13	TL13	TL13	TL13	TL13	TL13	TL13
Frosty White	TL16	TL16	TL16	TL16	TL16	TL16	TL16	TL16
Grey	TL62	—	TL62	TL62	—	TL62	TL62	—
Grey Elm	TL51	—	TL51	TL51	—	TL51	TL51	—
Kingswood Walnut	TL53	—	TL53	TL53	—	TL53	TL53	—
Manitoba	TL56	—	TL56	TL56	—	TL56	TL56	—
Neo Walnut	TL50	—	TL50	TL50	—	TL50	TL50	—
Platinum	TL61	—	TL61	TL61	—	TL61	TL61	—
Portico Teak	TL60	—	TL60	TL60	—	TL60	TL60	—
Skyline Walnut	TL15	TL15	TL15	TL15	TL15	TL15	TL15	TL15
Steel Mesh	TL59	—	TL59	TL59	—	TL59	TL59	—
Tuscan Walnut	TL57	—	TL57	TL57	—	TL57	TL57	—
Uptown Walnut	TL14	TL14	TL14	TL14	TL14	TL14	TL14	TL14

LAMINATE COLOR PROGRAM

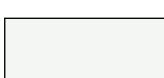





Laminate

Color	Code	
Grade 1		
Ankara Cherry	TL18	
Black	TL19	
Brazilian Walnut	TL20	
Cabinet Maple	TL21	
Driftwood	TL23	
Folkstone Grey	TL24	
Libretti	TL25	
Queenston Oak	TL26	
Sandalwood	TL27	
Walnut Amati	TL28	
White	TL29	

Laminate (Cont.)

Color	Code	
Grade 2		
Classic Linen	TL17	
Colombian Walnut	TL55	
Crisp Linen	TL64	
Designer White	TL66	
Field Elm	TL13	
Frosty White	TL16	
Grey	TL62	
Grey Elm	TL51	
Kingswood Walnut	TL53	
Manitoba Maple	TL56	
Neo Walnut	TL50	

Laminate (Cont.)

Color	Code	
Grade 2		
Platinum	TL61	
Portico Teak	MC60	
Skyline Walnut	TL15	
Steel Mesh	TL59	
Tuscan Walnut	TL57	
Uptown Walnut	TL14	

MESH COLOR PROGRAM











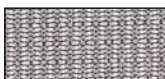

The following collections are available in the mesh color program: Amplify, Focus, Focus 2.0, Focus Side, Mavic, Movi, Novo, Qwiz, Torsa, Vectra, Wit and Wit Side. No minimum orders or additional costs apply.

Mesh



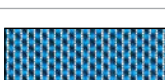



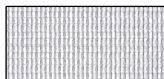

	Amplify	Flyte	Focus	Focus 2.0	Focus Side	Hexy	Mavic	Movi	Novo	Qwiz	Torsa	Vectra	Wit	Wit Side
Solids														
Apple	MC31	MC31	—	MC31	MC31	MC31	MC31	MC31	MC31	MC31	—	—	MC31	MC31
Aqua	MC30	MC30	—	—	MC30	—	—	MC30	MC30	MC30	—	—	MC30	MC30
Ash	—	—	—	MC45	—	—	—	—	—	—	—	—	—	—
Black	—	—	MC1	MC1	MC1	—	—	—	—	—	—	—	—	—
Charcoal	—	—	—	MC44	—	—	—	—	—	—	—	—	—	—
Desert	MC9	MC22	—	MC9	MC9	MC22	MC9	MC22	MC22	MC22	MC9	MC9	MC22	MC22
Dune	—	—	—	MC46	—	—	—	—	—	—	—	—	—	—
Electric Blue	MC24	MC24	—	MC13	MC24	MC24	MC13	MC24	MC24	MC24	—	—	MC24	MC24
Fire	MC10	MC25	—	MC10	MC10	MC25	MC10	MC25	MC25	MC25	MC10	—	MC25	MC25
Fog	MC7	MC23	—	MC7	MC7	MC23	MC7	MC23	MC23	MC23	MC7	—	MC23	MC23
Grape	—	MC26	—	—	—	—	—	MC26	MC26	MC26	—	—	MC26	MC26
Lemon	—	MC27	—	—	—	—	—	MC27	MC27	MC27	—	—	MC27	MC27
Midnight	—	—	—	MC43	—	—	—	—	—	—	—	—	—	—
Mist	—	—	—	—	—	—	—	—	—	—	—	MC41	—	—
Navy	MC8	—	—	MC8	MC8	MC8	MC8	—	—	—	MC8	MC8	—	—
Nickel	MC6	MC21	—	MC6	MC6	MC21	MC6	MC21	MC21	MC21	MC6	MC6	MC21	MC21
Ocean	—	MC29	—	MC29	—	MC29	MC29	MC29	MC29	MC29	—	—	MC29	MC29
Onyx	MC5	MC20	—	MC5	MC5	MC20	MC5	MC20	MC20	MC20	MC5	MC5	MC20	MC20
Platinum	—	—	—	—	—	—	—	—	—	—	—	MC42	—	—
Slate	—	—	MC2	MC2	MC2	—	—	—	—	—	—	—	—	—
Sand	—	—	MC3	MC3	MC3	—	—	—	—	—	—	—	—	—
Tangerine	MC28	MC28	—	MC28	MC28	MC28	MC28	MC28	MC28	MC28	—	—	MC28	MC28
Stripes														
Desert Stripe	—	—	—	—	—	—	—	—	—	—	MC16	—	—	—
Fog Stripe	—	—	—	—	—	—	—	—	—	—	MC15	—	—	—
Fog Woven Stripe	—	—	—	—	—	—	—	—	—	—	—	—	MC37	—
Freeway	—	—	MC33	MC33	MC33	—	—	—	—	—	—	—	—	—
Frost Woven Stripe	—	—	—	—	—	—	—	—	—	—	—	—	MC36	—
Impress	—	—	MC34	MC34	MC34	—	—	—	—	—	—	—	—	—
Nickel Woven Stripe	—	—	—	—	—	—	—	—	—	—	—	—	MC38	—
Onyx Stripe	—	—	—	—	—	—	—	—	—	—	MC14	—	—	—
Onyx Woven Stripe	—	—	—	—	—	—	—	—	—	—	—	—	MC35	—

MESH COLOR PROGRAM









Mesh

Mesh Color	Code	
Solids		
Apple	MC31	
Aqua	MC30	
Ash	MC45	
Black	MC1	
Charcoal	MC44	
Desert	MC9/ MC22	
Dune	MC46	
Electric Blue	MC13/ MC24	
Focus 2.0 Electric Blue	MC13	
Fire	MC10/ MC25	
Fog	MC7/ MC23	
Grape	MC26	
Lemon	MC27	

Mesh (Cont.)

Mesh Color	Code	
Solids		
Midnight	MC43	
Mist	MC41	
Navy	MC8	
Nickel	MC6/ MC21	
Ocean	MC5/ MC20	
Onyx	MC20	
Platinum	MC42	
Slate	MC2	
Sand	MC3	
Tangerine	MC28	

Mesh (Cont.)

Mesh Color	Code	
Stripes		
Desert Stripe	MC16	
Fog Stripe	MC15	
Fog Woven Striped	MC37	
Freeway	MC33	
Frost Woven Stripe	MC36	
Impress	MC34	
Onyx Stripe	MC35	
Onyx Woven Striped	MC35	

PLASTICS COLOR PROGRAM

From plastic shell colors to mesh colors to custom match colors, SitOnIt Seating gives designers and specifiers lots of options. The table below shows the plastic color options available by collection. All plastic shell colors are available with a 2-day lead time for production.







Plastics

	Anytime	Baja	Flyte	Freelance	Ioniq	InFlex	Lumin	Mika	OnCall	Orbitx	Relay	Qwiz	Rio	Rowdy	Sprout	Wit Side
Apple	–	SC24	–	–	–	–	SC24	–	–	SC24	–	–	SC24	SC24	–	–
Arctic	–	SC21	–	SC21	–	SC21	SC21	–	–	SC21	SC21	–	SC21	SC21	SC21	–
Black	SC1	SC1	SC1	SC1	SC1	SC1	SC1	SC1	SC1	SC1	SC1	SC1	SC1	SC1	SC1	SC1
Bisque	–	SC7	–	–	–	–	SC7	–	–	SC7	–	–	SC7	SC7	–	–
Chocolate	–	SC4	–	SC4	–	SC4	SC4	–	–	SC4	SC4	–	SC4	SC4	SC4	–
Fog	–	–	SC27	–	–	–	–	SC27	–	–	–	SC27	–	–	–	–
Lagoon	–	SC15	–	SC15	–	SC15	SC15	–	–	SC15	SC15	–	SC15	SC15	SC15	–
Latte	–	SC20	–	SC20	–	SC20	SC20	–	–	SC20	SC20	–	SC20	SC20	SC20	–
Lemon	–	SC25	–	–	–	–	SC25	–	–	SC25	–	–	SC25	SC25	–	–
Navy	SC5	SC5	–	SC5	–	SC5	SC5	–	SC5	SC5	SC5	–	SC5	SC5	SC5	SC5
Pacific	–	SC22	–	–	–	–	SC22	–	–	SC22	–	–	SC22	SC22	–	–
Red	–	SC19	–	SC19	–	SC19	SC19	–	–	SC19	SC19	–	SC19	SC19	SC19	–
Slate	SC8	SC8	–	SC8	–	SC8	SC8	–	SC8	SC8	SC8	–	SC8	SC8	SC8	SC8
Sterling	–	SC18	–	SC18	–	SC18	SC18	–	–	SC18	SC18	–	SC18	SC18	SC18	–
Tangerine	–	SC23	–	–	–	–	SC23	–	–	SC23	–	–	SC23	SC23	–	–
White	–	–	SC26	–	SC26	–	–	SC26	–	–	–	SC26	–	–	–	–

Plastic

Color	Code	
Apple	SC24	
Arctic	SC21	
Black	SC1	
Bisque	SC7	
Chocolate	SC4	
Fog	SC27	

Plastic (Cont.)

Color	Code	
Lagoon	SC15	
Latte	SC20	
Lemon	SC25	
Navy	SC5	
Pacific	SC22	
Red	SC19	

Plastic (Cont.)

Color	Code	
Slate	SC8	
Sterling	SC18	
Tangerine	SC23	
White	SC26	

MULTIPURPOSE CHAIR OPTIONS

		ACHIEVE	ANYTIME	BAJA	CORA	FLYTE	FOCUS SIDE	FREELANCE	FREELANCE BARIATRIC	INFLEX	IONIQ GUEST	IONIQ SIDE	LUMIN	MIKA	MOVI	ONCALL	ORBIX	QWIZ	RELAY	RIO	ROWDY	SPROUT	WIT SIDE	
BACK OPTIONS	Ballistic Nylon Back																							
	Mesh Back																							
	Plastic Back																							
	Upholstered Back																							
	Wood Back																							
SEAT OPTIONS	Plastic Seat																							
	Upholstered Seat																							
	+1" Seat Foam																							
HD SERIES	Heavy Duty (350 lb)																							
	Bariatric (500 lb)																							
	Bariatric (600 lb)																							
	Bariatric (750 lb)																							
	Bariatric (1000 lb)																							
FRAME OPTIONS	4-Leg																							
	4-Star																							
	Wire Rod/Sled																							
	Nester																							
	Black																							
	Chrome																							
	Fog																							
	Polished Aluminum																							
	Silver																							
	White																							
OTHER OPTIONS	Book Rack																							
	Ganging Bracket																							
	Stacking Cart																							
ARM OPTIONS	Armless																							
	Fixed																							
	Fixed Loop																							
	Tablet Arm																							

MULTIPURPOSE STOOL OPTIONS

		ANYTIME	BAJA	FOCUS SIDE	FREELANCE	INFLEX	KICKSTAND	LUMIN	MIKA	ONCALL	ORBIX	RIO
BACK OPTIONS	Ballistic Nylon Back											
	Mesh Back											
	Plastic Back											
	Upholstered Back											
	Wood Back											
SEAT OPTIONS	Plastic Seat											
	Upholstered Seat											
	+1" Seat Foam											
FRAME OPTIONS	Bar Stool											
	Counter Stool											
	4-Leg											
	Wire Rod/Sled											
	Black											
	Chrome											
	Fog											
	Polished Aluminum											
	Silver											
ARM OPTIONS	Armless											
	Fixed											
	Fixed Loop											

EXECUTIVE AND CONFERENCE CHAIR OPTIONS

		GLOVE ACTIVE	GLOVE EXECUTIVE	HEXY	PRAVA	SEPHIEN	SONA	TR2 EXECUTIVE
BACK OPTIONS	Midback							
	Highback							
	Executive Back							
	Ballistic Nylon Back							
	Mesh Back							
	Plastic Back							
	Knit Back							
	Upholstered Back							
	Headrest							
	Pull Bar							
HD	Heavy Duty (350 lb)							
SEAT	+1" Seat Foam							
	Upholstered Seat							
MECH + SEAT ADJ	Enhanced Synchro							
	Multi-Function							
	Posture Back							
MECH	Enhanced Synchro							
	Basic							
	Swivel-Tilt							
	Knee-Tilt							
	Multi-Function							
Posture Back								
FRAME	Black							
	Fog							
	White							

		GLOVE ACTIVE	GLOVE EXECUTIVE	HEXY	PRAVA	SEPHIEN	SONA	TR2 EXECUTIVE
FIXED ARMS	Armless							
	Fixed							
	Fixed Loop							
ARM ADJUSTMENT OPTIONS	Height							
	Height With Pivot							
	Multi (4-Way)							
	Multi (4-Way) With Pivot							
	Fully (6-Way)							
BASE OPTIONS	Black Nylon							
	Fog Nylon							
	Silver Metallic							
	White Nylon							
	Metal (Black							
	Brushed Aluminum							
	Polished Aluminum							
Higher Cylinder								

TASK CHAIR OPTIONS

		AMPLIFY	ANYTIME	FOCUS	FOCUS 2.0	HEXY	INFLEX	IONIQ	KNACK	LAVO	LUMIN	MAVIC	MOVI	NON-STOP	NOVO	ONCALL	ORBIX	REALIGN	RELAY	RIO	TORSA	TR2	VECTRA	WIT
BACK OPTIONS	Midback																							
	Highback																							
	Ballistic Nylon Back																							
	Mesh Back																							
	Plastic Back																							
	Thintex Back																							
	Upholstered Back																							
	Adjustable Lumbar																							
HD SERIES	Heavy Duty (350 lb)																							
	Large and Tall (400 lb)																							
	Extra Large (500 lb)																							
SEAT OPTIONS	+1" Seat Foam																							
	Large Seat Cushion																							
	Mesh Seat																							
	Plastic Seat																							
	Upholstered Seat																							
MECH + SEAT-DEPTH ADJUSTMENT	Advanced Synchro																							
	Enhanced Synchro																							
	Floating Synchro																							
	Standard Synchro																							
	Multi-Function																							
	Posture Back																							
MECH ADJUSTMENT	Enhanced Synchro																							
	Standard Synchro																							
	Basic																							
	Swivel-Tilt																							
	Knee-Tilt																							
	Multi-Function																							
	Posture Back																							

TASK CHAIR OPTIONS (CONT.)

		AMPLIFY	ANYTIME	FOCUS	FOCUS 2.0	HEXY	INFLEX	IONIQ	KNACK	LAVO	LUMIN	MAVIC	MOVI	NON-STOP	NOVO	ONCALL	ORBIX	REALIGN	RELAY	RIO	TORSA	TR2	VECTRA	WIT
FRAME OPTIONS	Accent Color																							
	Black																							
	Fog																							
	Graphite																							
	Silver																							
	White																							
FIXED ARM OPTIONS	Armless																							
	Fixed																							
	Fixed Loop																							
ARM ADJUSTMENT OPTIONS	Height																							
	Height With Pivot																							
	Multi (4-Way)																							
	Multi (4-Way) With Pivot																							
	Fully (6-Way)																							
	Fully (8-Way)																							
	Fully Multi (10-Way)																							
BASE OPTIONS	Black Nylon																							
	Fog Nylon																							
	Graphite Nylon																							
	Silver Nylon																							
	White Nylon																							
	Black Aluminum																							
	Brushed Aluminum																							
	Polished Aluminum																							
	Lower Cylinder																							
	Higher Cylinder																							

TASK STOOL OPTIONS

		AMPLIFY	ANYTIME	FOCUS	FOCUS 2.0	HEXY	INFLEX	KNACK	LUMIN	MOVI	NON-STOP	NOVO	ONCALL	ORBIX	REALIGN	RELAY	RIO	TR2	WIT
BACK OPTIONS	Midback																		
	Highback																		
	Ballistic Nylon Back																		
	Mesh Back																		
	Plastic Back																		
	Thintex Back																		
	Upholstered Back																		
	Adjustable Lumbar																		
HD	Heavy Duty (350 lb)																		
SEAT OPTIONS	+1" Seat Foam																		
	Plastic Seat																		
	Upholstered Seat																		
MECH	Basic																		
	Posture Back																		
FRAME OPTIONS	Black																		
	Fog																		
	Silver																		
	White																		
	Accent Color																		
FIXED ARM OPTIONS	Armless																		
	Fixed																		
	Fixed Loop																		
ARM ADJUSTMENT OPTIONS	Height																		
	Height With Pivot																		
	Multi (4-Way)																		
	Multi (4-Way) With Pivot																		
	Fully (6-Way)																		
	Fully Multi (10-Way)																		

TASK STOOL OPTIONS (CONT.)

		AMPLIFY	ANYTIME	FOCUS	FOCUS 2.0	HEXY	INFLEX	KNACK	LUMIN	MOVI	NON-STOP	NOVO	ONCALL	ORBIX	REALIGN	RELAY	RIO	TR2	WIT
BACK OPTIONS	Black Nylon																		
	Fog Nylon																		
	White Nylon																		
	Brushed Aluminum																		
	Polished Aluminum																		
	Stool Kit																		
	Extended Stool Kit																		

PRODUCT CODE INDEX

Code	Product
CAM SN1 FS8	Cameo Single Seat With Dual Arms
CAM SN1 FS10	Cameo Single Seat With Right Arm
CAM SN1 FS12	Cameo Single Seat With Left Arm
CAM SN1 FS17	Cameo Single Seat Bench
CAM SN2 FS8	Cameo 2-Seater With Dual Arms
CAM SN2 FS10	Cameo 2-Seater With Right Arm
CAM SN2 FS12	Cameo 2-Seater With Left Arm
CAM SN2 FS17	Cameo 2-Seater Bench
CAM SN3 FS8	Cameo 3-Seater With Dual Arms
CAM SN3 FS10	Cameo 3-Seater With Right Arm
CAM SN3 FS12	Cameo 3-Seater With Left Arm
CAM SN3 FS17	Cameo 3-Seater Bench
CAMT TTL1	Cameo Inline Table
CAMT TTL4	Cameo Corner Table
CAMT TT8	Cameo Square Coffee Table
CAMT TT9	Cameo Rectangular Coffee Table
CP AS1 SN1	Composium Sharp Club Chair
CP AS1 SN2	Composium Sharp Settee
CP AS1 SN3	Composium Sharp Sofa
CP AS2 SN1	Composium Flair Club Chair
CP AS2 SN2	Composium Flair Settee
CP AS2 SN3	Composium Flair Sofa
CP AS3 SN1	Composium Curve Club Chair
CP AS3 SN2	Composium Curve Settee
CP AS3 SN3	Composium Curve Sofa
CP FS1	Composium Ottoman
CP FS2 SN1	Composium 1-Seat Bench
CP FS2 SN2	Composium 2-Seat Bench
CP FS2 SN3	Composium 3-Seat Bench
ENV BH4	Envoi Midback Lounge Chair
ENV BH5	Envoi Highback Lounge Chair
FS30 CN1	Sable Club Chair With Arms
FS45 CN2	Sable Settee With Arms
FS49 CN3	Sable Sofa With Arms
FS59 CN2	Sable 2-Seat Bench
FS60 CN3	Sable 3-Seat Bench
GBI BH4	Gobi Midback Lounge Chair
MCM TT1	Mezzanine End Table
MCM TT2	Mezzanine Coffee Table
MCM TT3	Mezzanine Corner Table
MCM TT4	Mezzanine Oval Occasional Table
MCM TT5	Mezzanine Rectangular Occasional Table
MCM TT6	Mezzanine Round Occasional Table
MCM TT8	Mezzanine Square Occasional Table
NNO FS13	Nano Triangle

Code	Product
NNO FS14	Nano Diamond
NNO FS15	Nano Trapezoid
NNO FS16	Nano Boomerang
PAS FS1 OS1	Paséa Mini Round Ottoman
PAS FS1 OS2	Paséa Large Round Ottoman
PAS FS1 OS3	Paséa Mini Square Ottoman
PAS FS1 OS4	Paséa Large Square Ottoman
PAS FS2 BNS1	Paséa Single Bench
PAS FS2 BNS2	Paséa 1.5 Bench
PAS FS2 BNS3	Paséa Right-Angled End Bench
PAS FS2 BNS4	Paséa Left-Angled End Bench
PAS FS2 BNS5	Paséa 90-Degree Corner Bench
PAS FS2 BNS5	Paséa 120-Degree Bench
PAS FS17 SS1	Paséa Single Seat
PAS FS17 SS2	Paséa 1.5 Seat
PAS FS17 SS5	Paséa 90-Degree Corner Seat
PAS FS17 SS3	Paséa 120-Degree Inner Seat
PAS FS17 SS4	Paséa 120-Degree Outer Seat
PAS FS18 BNS1	Paséa 27" x 27" Table
PAS FS18 BNS5	Paséa 90-Degree Corner Table
PAS FS18 BNS7	Paséa 13" x 27" Table
VRC SN2	Aviera Pre-Configured 2-Seat
VRC SN3	Aviera Pre-Configured 3-Seat
VRG	Aviera Guest and Bariatric Seating
VRG FS3	Aviera Hip Chair
VRG SN2	Aviera Freespan 2-Seat
VRG SN3	Aviera Freespan 3-Seat
VRL TTL1	Aviera Center Linking Table
VRL TTL3	Aviera End Linking Table
VRL TTL4	Aviera Round 90-Degree Linking Table
VRL TTL5	Aviera Square 90-Degree Linking Table
VRM FS4	Aviera Tandem Seating: Start
VRM FS5	Aviera Tandem Seating: Center
VRM FS6	Aviera Tandem Seating: End
VRP	Aviera Patient Seating
VS	Visit Modular Armless Club Chair
VS FS1	Visit Modular Ottoman
VS FS8	Visit Modular Club Chair With Arms
VS FS10	Visit Modular Club Chair With Right Arm Only
VS FS12	Visit Modular Club Chair With Left Arm Only
40	TR2 Task Chair
40E	TR2 Executive Chair
40 S1/S2	TR2 Task Stool
90	OnCall Wire Rod Chair
90 S2	OnCall Wire Rod Bar Stool

PRODUCT CODE INDEX

Code	Product
90T	OnCall Light Task Chair
90T S1/S2	OnCall Light Task Stool
91	Achieve Multipurpose Chair
92	Rowdy Wire Rod Chair
93	Anytime Multipurpose Chair
93 S2	Anytime Multipurpose Bar Stool
93T	Anytime Light Task Chair
93T S1/S2	Anytime Light Task Stools
94F	Relay Nester Chair
94T	Relay Light Task Chair
94T S1/S2	Relay Light Task Stool
671	Non-Stop Heavy Duty Task Stool
673	Non-Stop Heavy Duty Task Chair
681	ReAlign Midback Task Chair
682	ReAlign Highback Task Chair
971/974	Inflex Multipurpose Chair
971 S2	Inflex Multipurpose Bar Stool
971 S9	Inflex Multipurpose Counter Stool
973B	Inflex Light Task Chair
973B S1/S2	Inflex Light Task Stool
1011 FT1	Lumin 4-Leg Multipurpose Chair
1011 FT1 S2	Lumin Multipurpose Bar Stool
1011 FT1 S9	Lumin Multipurpose Counter Stool
1011 FT2	Lumin Wire Rod Multipurpose Chair
1012 FT3	Lumin Light Task Chair
1012 FT3 S21/S22	Lumin Light Task Stool
1051 FT1	Rio 4-Leg Multipurpose Chair
1051 FT1 S2	Rio Multipurpose Bar Stool
1051 FT1 S9	Rio Multipurpose Counter Stool
1051 FT2	Rio Wire Rod Multipurpose Chair
1052 FT3	Rio Light Task Chair
1052 FT3 S21/S22	Rio Light Task Stool
1152 FT5	Ioniq Guest Chair
1664 BK3	Sephen Lowback Conference Chair
1664 BK2	Sephen Highback Conference Chair
1664 BK5	Sephen Executive Back Conference Chair
1073	Vectra Highback Task Chair
1033 BK1	Novo Mesh Midback Task Chair
1033 BK2	Novo Mesh Highback Task Chair
1033 BK1 S1/S2	Novo Mesh Midback Task Stool
1061 FT4 MB	Movi Meshback Nester Chair
1062 FT3 MB	Movi Mesh Light Task Chair
1062 FT3 MB S21/S22	Movi Mesh Light Task Stool
1101 FT1	Mika 4-Leg Multipurpose Chair

Code	Product
1101 FT2	Mika Wire Rod Multipurpose Chair
1101 FT2 S2	Mika Wire Rod Bar Stool
1101 FT2 S9	Mika Wire Rod Counter Stool
1141 FT4	Qwiz Nester Chair
1113	Mavix Collaborative Chair
1123 BK1 MB	Focus 2.0 Mesh Midback Task Chair
1123 BK2 MB	Focus 2.0 Mesh Highback Task Chair
1123 BK1 MB S1/S2	Focus 2.0 Mesh Midback Task Stool
1131 FT2	Orbix Wire Rod Chair
1131 FT2 S2	Orbix Wire Rod Bar Stool
1132 FT3 CH1	Orbix Light Task Chair
1132 FT3 CH1 S21/S22	Orbix Light Task Stool
1152 FT1	Ioniq Side Chair
1152 FT3	Ioniq Collaborative Chair
1167	Kickstand Sit-to-Stand Stool
1171 FT1	Baja 4-Leg Multipurpose Chair
1171 FT2	Baja Multipurpose Wire Rod Chair
1171 FT2 S2	Baja 30" Wire Rod Bar Stool
1181	Sprout Wire Rod Multipurpose Chair
1191 SW19	Cora Multipurpose Guest Chair
1191 SW26	Cora Midsize Guest Chair
1191 SW30	Cora Bariatric Chair
1191 SW19 S2	Cora Bar Stool
1191 SW19 S4	Cora Easy Access Hip Chair
1191 SW19 S9	Cora Counter Stool
1673 BK2	Lavo Highback Task Chair
1203 BK1	Hexy Mesh Midback Task Chair
1203 BK2	Hexy Mesh Highback Task Chair
1203 BK1 S1/S2	Hexy Mesh Midback Task Stools
1651 FT4	Flyte Stacking Nester Chair
2080 NH SW21	Kindl Guest Chair
2080 NH SW30	Kindl 30" Bariatric
2080 NH SW42	Kindl 42" Bariatric
2082 SW42	Kindl Freespan
2083 FS4 SW21	Kindl Start 21"
2083 FS4 SW30	Kindl Start 30"
2083 FS4 SW42	Kindl Start 42"
2083 FS5 SW21	Kindl Center 21"
2083 FS5 SW30	Kindl Center 30"
2083 FS5 SW42	Kindl Center 42"
2083 FS6 SW21	Kindl End 21"
2083 FS6 SW30	Kindl End 30"
2083 FS6 SW42	Kindl End 42"
2084 SW42	Kindl Pre-Configured

PRODUCT CODE INDEX

Code	Product
2086 TTL1	Kindl Center In-Line Table
2086 TTL4	Kindl 90° Corner Table
2221 FT1 MB	Wit Mesh Side Chair
2221 FT1 TXB	Wit Thintex Side Chair
2222 B1	Wit Mesh Midback Task Chair
2222 B1 S1/S2	Wit Mesh Midback Task Stool
2222 B9	Wit Thintex Midback Task Chair
2222 B9 S1/S2	Wit Thintex Midback Task Stool
2223 B1	Wit Mesh Highback Task Chair
2223 B9	Wit Thintex Highback Task Chair
2722 B1	Amplify Mesh Midback Task Chair
2722 B1 S1/S2	Amplify Mesh Midback Task Stool
2723 B1	Amplify Mesh Highback Task Chair
2723 B3	Amplify Upholstered Highback Task Chair
3021/3022	Prise Fixed Benching
3061/3062	Ocala Fliptop Table
3090 DT101	Sector Worksurface Screen
3090 DT301	Doodle Worksurface Screen
3090 DT701	Motif Fabric Worksurface Screen
3092 DT701	Motif Fabric Mobile + Freestanding Screen
3092 DT101	Sector Acrylic Mobile + Freestanding Screen
3093 DT101	Sector Acrylic Modesty Screen
3093 DT501	Laminate Modesty Screen
3093 DT701	Motif Modesty Screen
3096 CRSC	Sector Acrylic Round Café Screen
3096 CSSC	Sector Acrylic Square Café Screen
3096 TFSC	Sector Acrylic Tri-Fold Screen
3096 TRSC	Sector Acrylic Transaction Screen
3111 MAT06	Unity G2 Single Screen Arm
3111 MAT07	Unity G2 Dual Screen Arm
3120	Hightide Sit-to-Stand
3130 PCC/PCU	Current Power Module
3130 PTC	EON Power Module
3140	Rhythm Lighting
3150	Mobile Pedestal
3151	Keyboard Tray
3152	Cable Caddy Wire Management
3153	Anti-Fatigue Mat
3154	Laptop Tray
3155	Pencil Storage
3156 CPUS1	CPU Storage Band
3156 CPUS3	CPU Under Desk/Wall Mount
3161/3162 TBT6	Switchback 2-Stage 2-Leg T-Leg HAT
3161/3162 TBT7	Switchback 3-Stage 2-Leg T-Leg HAT
3161/3162 TBT6C	Switchback 2-Stage 2-Leg C-Leg HAT

Code	Product
3161/3162 TBT7C	Switchback 3-Stage 2-Leg C-Leg HAT
3161/3162 TBT8C	Switchback 3-Stage 3-Leg C-Leg HAT
3210 MAT30	Mobio Single Pole Monitor Arm
3210 MAT31	Mobio Dual Pole Monitor Arm
3210 MAT32	Mobio Triple Pole Monitor Arm
3210 MAT33	Mobio Single Desk Monitor Arm
3210 MAT34	Mobio Dual Desk Monitor Arm
3210 MAT35	Mobio Heavy Duty Single Desk Monitor Arm
3210 MAT36	Mobio Heavy Duty Dual Desk Monitor Arm
3210 MAT37	Mobio Heavy Duty Dual Array Monitor Arm
3231/3232	Tensor Tables
3242	EBeam
3260	Uni Laptop Table
3271 TBT2	Parallon T-Leg Flip-Top Table
3271 TBT3	Parallon T-Leg Fixed Top Table
3271 TBT3C	Parallon C-Leg Fixed Top Table
3271 TBT4	Parallon X-Base Table
3271 TBT15	Parallon Disc-Base Table
3271 TBT16	Parallon Dual Disc-Base Table
3291/3292	HiQ HA Benching
3301 TBT6	Surge 2-Stage 2-Leg T-Leg HAT
3301 TBT6C	Surge 2-Stage 2-Leg C-Leg HAT
3323	Knack Upholstered Midback Task Chair
3323 S1/S2	Knack Upholstered Midback Task Stool
5213/5213/5214/5214	Freelance Multipurpose Chair
5214 S2	Freelance Multipurpose Bar Stool
5214 S9	Freelance Multipurpose Counter Stool
5314	Freelance Multipurpose Counter Stool
5414	Freelance 30" Bariatric Chair
5414	Freelance 42" Bariatric Chair
5622 B1	Focus Mesh Midback Task Chair
5623 B1	Focus Mesh Highback Task Chair
5622 B1 S1/S2	Focus Mesh Midback Task Stool
5623 B1 S1/S2	Focus Mesh Highback Task Stool
5622 B4	Focus Upholstered Midback Task Chair
5622 B4 S1/S2	Focus Upholstered Midback Task Stool
5623 B4	Focus Upholstered Highback Task Chair
5623 B4 S1/S2	Focus Upholstered Highback Task Stool
5641/5642/5651/5652	Focus Side Multipurpose Chair (Black/Silver)
5651/5652 S2	Focus Side Multipurpose Bar Stool
5651/5652 S9	Focus Side Multipurpose Counter Stool
5723 B7	Sona Knit Conference Chair
5723 B8	Sona Upholstered Conference Chair
6023	Torsa Mesh Task Chair
6422	Prava Midback Conference Chair

PRODUCT CODE INDEX

Code	Product
6423	Prava Highback Conference Chair
7531	Glove Active Midback Conference Chair
7532	Glove Active Midback Conference Chair
7541	Glove Executive Midback Conference Chair
7542	Glove Executive Midback Conference Chair